

HandSCOPE

CA 922 - 20 MHz

CA 942 - 40 MHz



Portable Oscilloscopes

Thank you for purchasing this portable digital oscilloscope with channels isolated from each other and from earth.

To obtain the best service from your instrument:

- **Read** these user manual carefully,
- **Comply with** the precautions for use.

CA 922	color screen	2 channels	20 MHz	scale 50 MS/s
CA 942	color screen	2 channels	40 MHz	scale 50 MS/s

 **WARNING, DANGER!** The operator should refer to this user's manual whenever this danger symbol appears.

 **WARNING, risk of electric shock.** The voltage on the parts marked with this symbol may be dangerous.

 Useful information or tip.

 Equipment protected by double insulation.

 Chauvin Arnoux has adopted an Eco-Design approach in designing this appliance. Analysis of the complete lifecycle has enabled us to control and optimize the effects of the product on the environment. In particular this appliance exceeds regulation requirements with respect to recycling and reuse.

 The CE marking indicates compliance with the European Low Voltage Directive (2014/35/EU), Electromagnetic Compatibility Directive (2014/30/EU), and Restriction of Hazardous Substances Directive (RoHS, 2011/65/EU and 2015/863/EU).

 The UKCA marking certifies that the product is compliant with the requirements that apply in the United Kingdom, in particular as regards Low-Voltage Safety, Electromagnetic Compatibility, and the Restriction of Hazardous Substances.

 The rubbish bin with a line through it indicates that, in the European Union, the product must undergo selective disposal in compliance with Directive WEEE 2012/19/EU. This equipment must not be treated as household waste.

Definition of measurement categories

- Measurement category IV corresponds to measurements taken at the source of low-voltage installations.
Example: power feeders, counters and protection devices.
- Measurement category III corresponds to measurements on building installations.
Example: distribution panel, circuit-breakers, machines or fixed industrial devices.
- Measurement category II corresponds to measurements taken on circuits directly connected to low-voltage installations.
Example: power supply to electro-domestic devices and portable tools.

PRECAUTIONS FOR USE

This device is compliant with safety standard IEC/EN 61010-2-030 or BS EN 61010-2-030, the leads are compliant with IEC/EN 61010-031 or BS EN 61010-031, and the current sensors are compliant with IEC/EN 61010-2-032 or BS EN 61010-2-032, for voltages up to 600 V in category III or 1,000 V in category II.

Do not use the instrument for measurements on circuits that are not in measurement categories II, III, or IV or that might be connected inadvertently to circuits that are not in measurement categories II, III, or IV.

- The operator and/or the responsible authority must carefully read and clearly understand the various precautions to be taken in use. Sound knowledge and a keen awareness of electrical hazards are essential when using this instrument.
- If you use this instrument other than as specified, the protection it provides may be compromised, there by endangering you.
- Do not use the instrument on networks of which the voltage or category exceeds those mentioned.
- Do not use the instrument if it seems to be damaged, incomplete, or poorly closed.
- Before each use, check the condition of the insulation on the leads, housing, and accessories. Any item of which the insulation is deteriorated (even partially) must be set aside for repair or scrapping.
- Before using your instrument, check that it is perfectly dry. If it is wet, it must be thoroughly dried before it can be connected or used.
- Use only the leads and accessories supplied. The use of leads (or accessories) of a lower voltage or category limits the voltage or category of the combined instrument and leads (or accessories) to that of the leads (or accessories).
- Use personal protection equipment systematically.
- When handling the leads, test probes, and crocodile clips, keep your fingers behind the physical guard.
- Any troubleshooting or metrological verification procedure must be carried out by accredited skilled personnel.

CONTENTS

1. FIRST START-UP	6
1.1. Unpacking.....	6
1.2. Accessories	6
2. DESCRIPTION OF THE INSTRUMENT	7
2.1. Presentation	7
2.2. Power supply.....	7
2.3. Batteries	7
2.4. Channel insulation.....	8
2.5. CA 922 & CA 942.....	9
2.6. Advice for use of the sensors	10
2.7. Sensor calibration.....	11
2.8. Front panel description.....	13
3. OSCILLOSCOPE MODE "THE KEYS"	14
3.1. "Menu" key	14
3.2. 3 Channel A, B and Math or Memory keys.....	14
3.3. 2 "Time base" keys.....	15
3.4. 2 "Sensitivity" keys	15
3.5. 2 Functional keys.....	15
4. OSCILLOSCOPE MODE "DISPLAY"	16
4.1. Display.....	16
4.2. Channel data	16
4.3. Main display.....	18
4.4. Time data.....	18
5. OSCILLOSCOPE MODE "THE MENUS"	19
5.1. Display.....	19
5.2. Organization	19
5.3. Main menu area.....	19
5.4. Secondary menu area	19
5.5. Navigation.....	20
6. OSCILLOSCOPE MODE - THE CHANNEL "A" OR "B" MENU	22
6.1. The channel "A" or "B" menu.....	22
7. OSCILLOSCOPE MODE "THE MATH CHANNEL MENU"	26
7.1. The "M Channel" menu	26
8. OSCILLOSCOPE MODE "THE TRIGGER MENU"	30
8.1. The "Trigger" menu.....	30
8.2. Description.....	31
8.3. Examples	32
9. OSCILLOSCOPE MODE "THE ACQUISITION MENU"	35
9.1. The "Acquisition" menu	35
9.2. Examples.....	36
10. OSCILLOSCOPE MODE "THE MEASUREMENT MENU"	39
10.1. The "Measurement" menu.....	39
11. OSCILLOSCOPE MODE "THE MEMORY MENU"	42
11.1. The "MEMORY" menu	42
11.2. Example.....	43
11.3. Description.....	44
12. OSCILLOSCOPE MODE "THE TOOLS MENU"	45
12.1. The "TOOLS" menu.....	45
13. OSCILLOSCOPE MODE "THE HELP KEY"	46
13.1. The "HELP" key.....	46
14. MULTIMETER MODE "THE KEYS"	47
14.1. 6 "Menu" keys.....	47
14.2. 3 keys : Channel A, B and Math	47
14.3. "Time base" keys.....	48
14.4. 2 "SENSITIVITY" keys.....	48
14.5. Functional keys.....	48
15. MULTIMETER MODE "DISPLAY"	49
15.1. Display.....	49
15.2. Measurement zone	49
15.3. Graphic window area.....	50
15.4. Main menu area.....	50
15.5. Secondary menu area	50

16. MULTIMETER MODE "THE MEASUREMENT MENU"	51
16.1. THE "MEASUREMENT" menu	51
16.2. Description	51
17. MULTIMETER MODE "THE CHANNEL A OR B MENU"	54
17.1. The channel "A" or "B" menu	54
17.2. Notes	54
17.3. Example : Multimeter coupling	55
18. MULTIMETER MODE "THE MEMORY MENU"	56
18.1. The "MEMORY" menu	56
19. HARMONIC ANALYSER MODE "THE KEYS"	57
19.1. "Menu" keys.....	57
19.2. 3 keys channel "A" + "B" and Math.....	57
19.3. 2 "TIME BASE" keys	58
19.4. 2 "SENSITIVITY" keys.....	58
19.5. 2 functional keys.....	58
20. HARMONIC ANALYSER MODE "DISPLAY"	59
20.1. Display	59
20.2. Measurement zone	59
20.3. Harmonic display area	60
20.4. Harmonic reference area	60
20.5. Main and secondary menu zones.....	60
21. HARMONIC ANALYSER MODE "THE CHANNEL A OR B MENU"	61
21.1. The Channel "A" or "B" menu	61
22. HARMONIC ANALYSER MODE "ACQUISITION MENU"	62
22.1. The "Acquisition" menu	62
23. HARMONIC ANALYSER MODE "MEMORY MENU"	63
23.1. The "MEMORY" menu	63
24. REMOTE PROGRAMMING	64
24.1. Presentation	64
24.2. Connecting the oscilloscope	64
24.3. Updating	64
25. TECHNICAL SPECIFICATIONS "OSCILLOSCOPE MODE"	65
25.1. Vertical deflection	65
25.2. Horizontal deflection (time base)	66
25.3. Trigger circuit	66
25.4. Acquisition chain	67
25.5. Formats of the different files	67
25.6. Measurement processing	68
25.7. Display	69
26. TECHNICAL SPECIFICATIONS "ACCESSORIES"	70
27. TECHNICAL SPECIFICATIONS "MULTIMETER MODE"	71
28. NETWORK "HARMONIC ANALYSIS MODE "	73
29. COMMUNICATION INTERFACES	73
29.1. USB/OPTICAL interface	73
30. GENERAL SPECIFICATIONS	74
30.1. Environment	74
30.2. Power supply	74
30.3. 	74
31. MECHANICAL SPECIFICATIONS	75
31.1. Box	75
31.2. Packaging	75
32. SUPPLY	75
32.1. Accessories	75
33. MAINTENANCE	76
33.1. Cleaning	76
33.2. Updating the internal software of the instrument	76
34. WARRANTY	76
35. REMOTE PROGRAMMING MANUAL	77
35.1. Presentation	77
35.2. Connection of the instrument	77
35.3. Programming convention	77
35.4. Command syntax	78
35.5. Response syntax	79

36. COMMANDS SPECIFIC TO THE INSTRUMENT "OSCILLOSCOPE MODE"	80
36.1. Vertical	80
36.2. Trigger	81
36.3. Horizontal	83
36.4. Display	84
36.5. Measure	84
36.6. Memory	87
36.7. Utilities	89
36.8. Help	92
37. COMMANDS SPECIFIC TO THE INSTRUMENT "MULTIMETER MODE"	93
37.1. Vertical	93
37.2. Recording time	94
37.3. Measurement	94
37.4. Error	94
38. IEEE 488.2 COMMON COMMANDS	96
38.1. Introduction	96
38.2. Events and status management	96
38.3. IEEE 488.2 Commands	98
38.4. Tree structure	100
39. SCPI COMMANDS	101

1. FIRST START-UP

1.1. UNPACKING

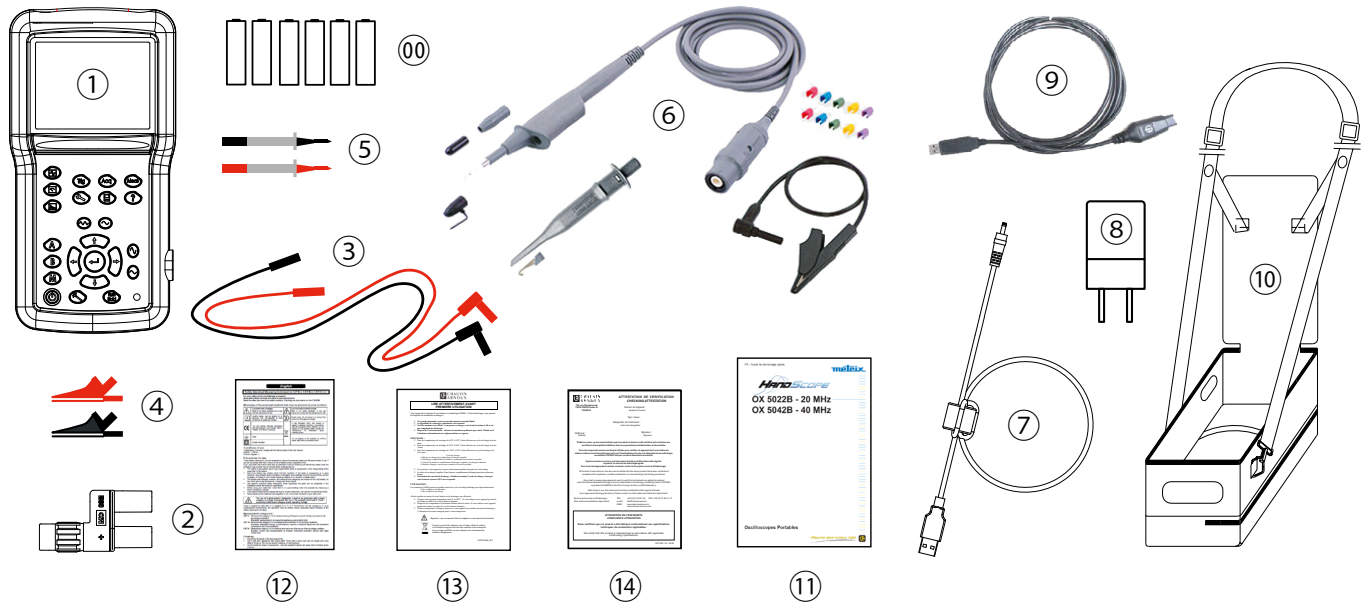

		CA 922	CA 942
00	6 NiMH 1.2 V rechargeable batteries	✓	✓
1	one portable oscilloscope	✓	✓
2	BNC-banana adapter	✓ x2	✓ x1
3	set of PVC straight-elbow banana leads (1.5m, red and black)	✓ x2	✓ x1
4	set of crocodile clips (red and black)	✓ x2	✓ x1
5	set of 1000V CAT-IV contact tips (red and black)	✓ x2	✓ x1
6	probe 10:1 600V/BNC M		✓
7	jack to USB cord	✓	✓
8	USB WALLPLUG	✓	✓
9	optical to USB cord	✓	✓
10	carrying bag	✓	✓
11	Quick start guide (QSG)	✓	✓
12	safety data sheet	✓	✓
13	NiMH battery connector	✓	✓
14	Checking attestation	✓	✓
	packaging box	✓	✓

1.2. ACCESSORIES

- PWM PROBE
- E27 CVH OSCILLO CLAMP

For the accessories and spares, consult our web site:

www.chauvin-arnoux.com

2. DESCRIPTION OF THE INSTRUMENT

2.1. PRESENTATION

The particularity of these oscilloscopes is that they group 3 instruments in one:

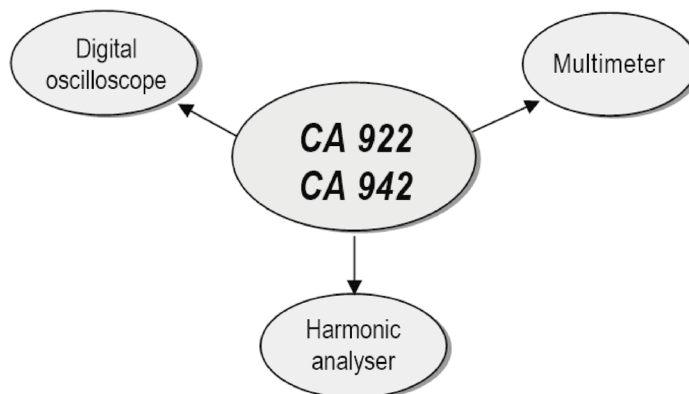

- a laboratory digital oscilloscope for the analysis of electronic and electrotechnical signals,
- a 2-channel, 8000-count multimeter,
- a harmonic analyser, for the simultaneous decomposition of 2 signals with their fundamental and their first 31 harmonics.

The instrument operates at a constant acquisition depth of 2,500 points.
An LCD TFT screen is used to view the applied signals along with all the setting parameters.
The main command functions are accessible using the keys on the front panel.

A graphic interface is used to:

- adjust the parameters related to the selected button,
- navigate using a horizontal main menu showing the current settings and vertical sub-menus.

2.2. POWER SUPPLY

The oscilloscope is delivered with:

- one mains to USB supply and one jack to USB cord with a ferrite
Voltage: 5 VDC
Power: 2 A

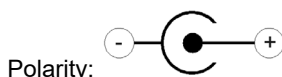

- 6 rechargeable → NiMH (1.2 V - LR6 or AA) accumulator batteries.

When the external power supply is connected, this power source is preferred for the instrument's operation. Thus the accumulators are only used when there is no external power supply.



With the external power supply you can use your oscilloscope even if the batteries are flat, defective or even absent.

2.3. BATTERIES



A "battery empty" indicator appears on the screen when the accumulator-battery charge level is insufficient and a new power source is needed quickly:

- connect the external power supply or
- change the batteries.

If the external power supplied is not connected when the level becomes critical, an alarm message "Battery level is critical, the appliance is about to power off" precedes the automatic shutdown of the instrument.

2.3.1. CHARGE

The batteries are charged when the oscilloscope is powered off but connected to the external power supply. During the fast charge of the batteries, the front-panel LED is on.

It flashes in the following situations:

- pre-charge of very flat batteries
- temperature too low or too high
- batteries damaged.

The batteries must be replaced with rechargeable Ni-MH batteries. The life between charges will be the same as with the batteries supplied with the oscilloscope if the replacement batteries have the same capacity (indicated in Ah).

The LED goes off when charging is complete.

If charging is interrupted before it is complete, the LED remains on for one minute to remind the user that the batteries are not fully charged.



It is possible, but not recommended, to use standard alkaline batteries (AA type) to replace the accumulators, but in this case be careful:

- not to connect the external power supply because when the instrument is switched off the charge mechanism is activated which can lead to destruction of the batteries and damage to the instrument;
- not to leave the batteries in the instrument for too long to avoid any problems caused by leakage from the batteries.

2.3.2. ACCESS

If necessary, the batteries(1) are accessible from the rear panel of the oscilloscope after turning the "quarter turn" (2) lock anti-clockwise; use a coin (3):

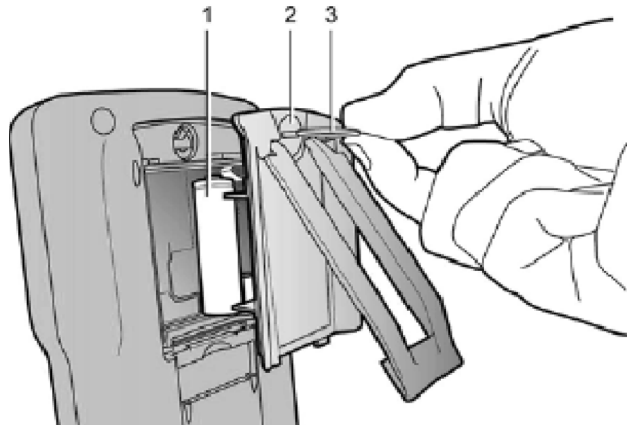

Spent batteries must not be treated as ordinary household waste. Take them to the appropriate recycling collection point.

2.4. CHANNEL INSULATION



The two oscilloscope input channels are insulated from each other and from the earth and the mains power supply block. This insulation is double or reinforced in compliance with the safety standards IEC/EN 61010-1 or BS EN 61010-1 and IEC/EN 61010-2-030 or BS EN 61010-2-030.

This makes it possible to make measurements on installations or systems connected to the electricity supply network for voltages of up to 600 V in CAT III. The common mode authorised between the two channels is 600 V in CAT III.

Thus the operator, the test systems and the environment are completely protected at all times.

Any voltage (even dangerous) on one channel will not be present on the other channel. The low points of the inputs are completely insulated, so there is no possibility of the low points looping (which can be dangerous and highly destructive). The oscilloscope insulation is as shown in the diagram below:

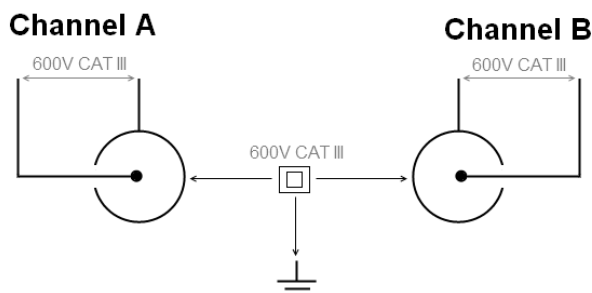



The use of accessories with a voltage and/or category lower than 600 V CAT III reduces the operating range to the lower voltages and/or categories.
Your oscilloscope is rated 600 V CAT III; at least 600 V CAT III accessories must be used. The accessories shipped with the instrument allow this.

2.5. CA 922 & CA 942

2.5.1. FRONT PANEL

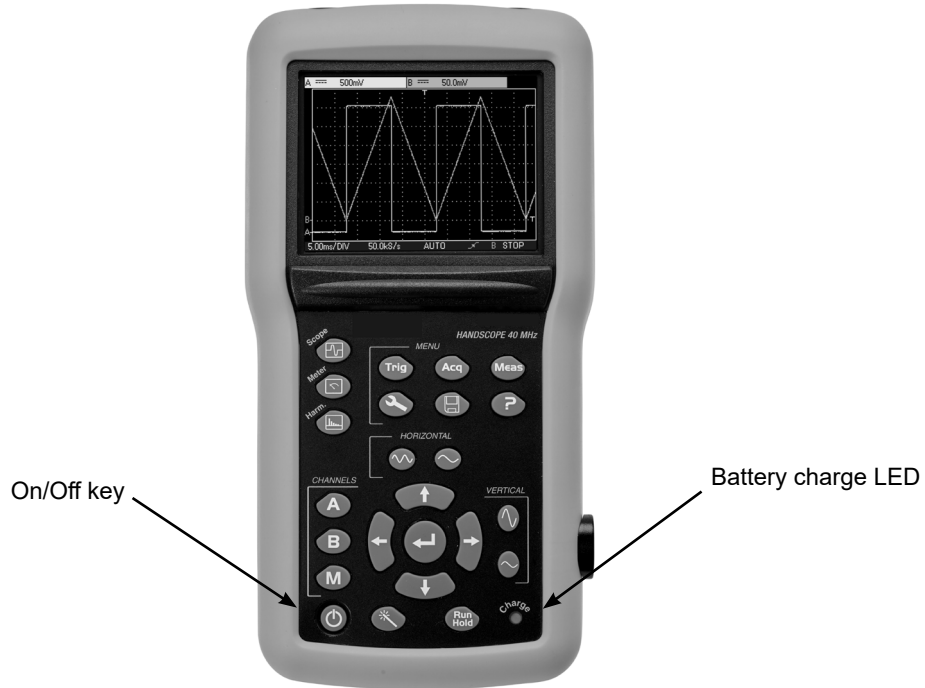

2.5.2. BACK FACE

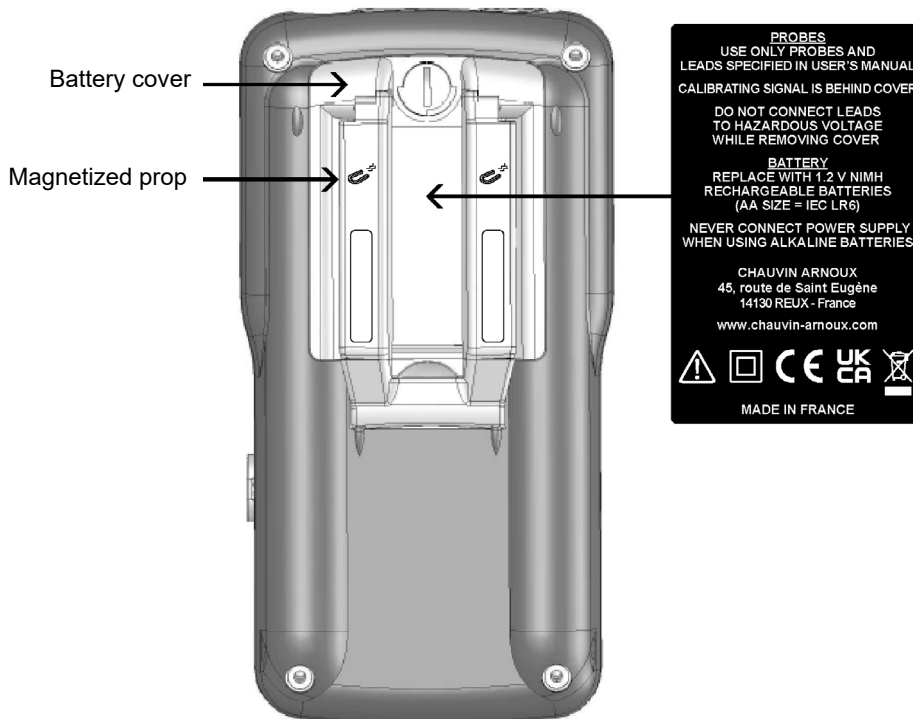

The retractable prop can hold the instrument in position at 30° from the horizontal.

2.5.3. MEASUREMENT TERMINAL

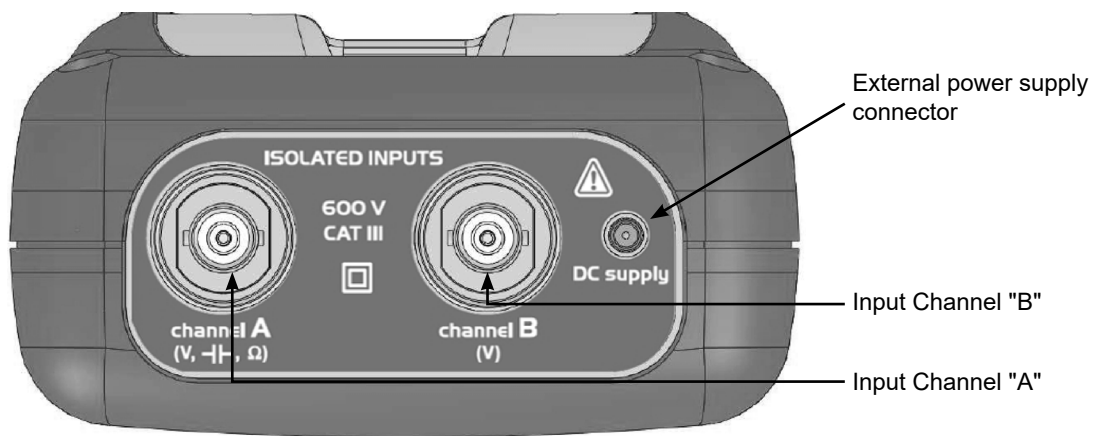

2.5.4. SIDE

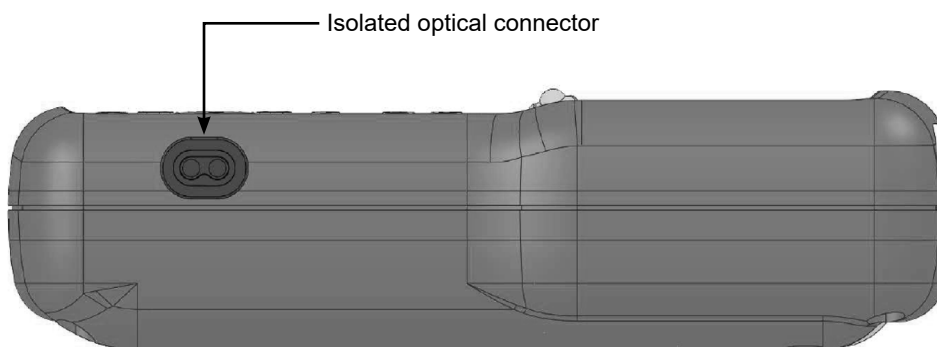

2.6. ADVICE FOR USE OF THE SENSORS

2.6.1. CONNECTION OF THE REFERENCE CONDUCTORS TO THE SENSOR

Distribution of stray capacitors:

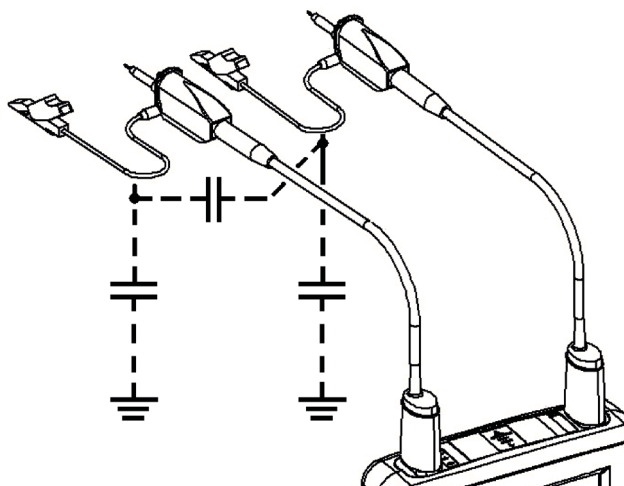

It is imperative, considering the stray capacitances, to correctly connect the reference conductors for each sensor. The conductors should preferably be connected to the cold points to avoid the transmission of noise by the stray capacitance between modes.

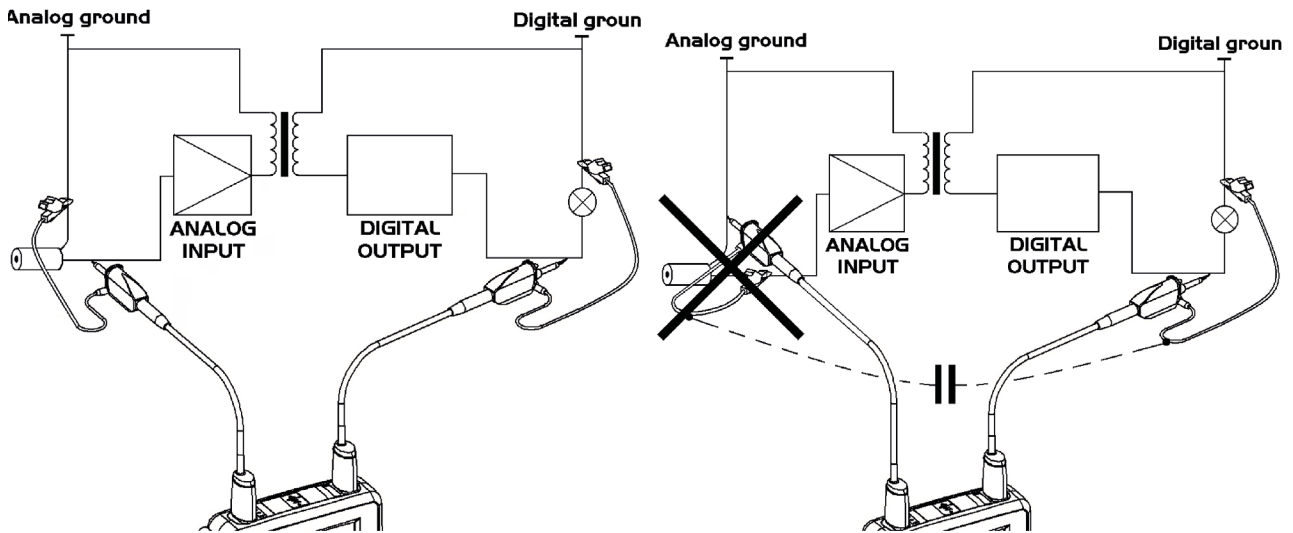

The noise of the digital ground (earth) is sent to the analogue input by the stray capacitance.



Reminder: In order to prevent electric shocks or possible fires:

Never use accessories on which the casing is accessible if it has a voltage of $> 30 \text{ Vrms}$ compared to the earth.

This precaution is necessary for example for sensors with an accessible metal BNC. The accessories shipped with the instrument are compliant.



Reminder: Definitions of the symbols and precautions of use per the IEC/EN 61010-2-032 or BS EN 61010-2-032 standard, max. voltage 600 V in Category III (with respect to earth and between the two channels).

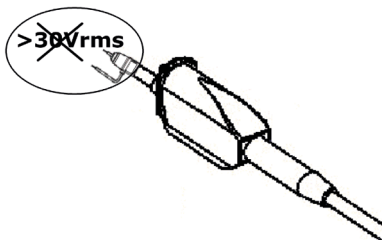

2.7. SENSOR CALIBRATION

The calibration output (3 Vpp , 1 kHz) for the sensors is underneath the battery cover (see § 2.5.2. Back face).

To obtain optimum response, the sensor's low frequency compensation must be adjusted. To carry out this adjustment, the two channels of your oscilloscope must be disconnected from the measured circuits before opening the battery housing cover.



Connect the sensor to be adjusted to the calibration output under the battery housing cover, as shown opposite.



Select the DC coupling for the channel to which the sensor is connected and run an autoset (icon opposite) to carry out pre-setting. Adjust the sensitivity and the vertical offset of the channel so that the signal fills the screen, and adjust the time base to 200 μ s to view a signal period on the screen. Turn the BNC base of the sensor in order to access the sensor adjustment screw:



In the example opposite the sensor is over-compensated: an overshoot occurs.

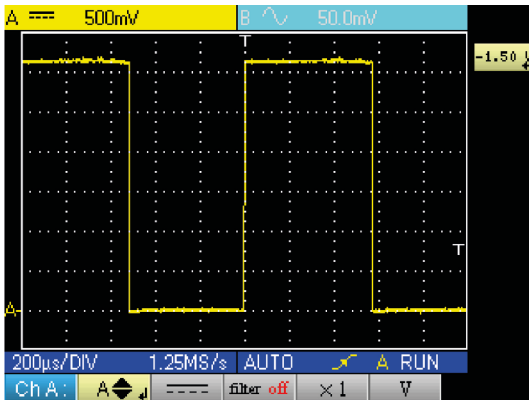

Turn the screw in either direction until the signal is horizontal and looks like the screen shown opposite. Your sensor is now calibrated, so you can turn the BNC base again to close access to the adjustment screw.



Replace the battery cover in order to use your instrument in optimum safety conditions.

2.8. FRONT PANEL DESCRIPTION

The main functions of the instrument are accessed from the front panel.

2.8.1. ON / OFF KEY



The instrument is switched on by a short press on the key shown opposite. It is switched off by a long press (a shutdown message appears and a beep sounds).

2.8.2. OPERATING MODE KEYS

Pressing one of these three keys selects the instrument's operating modes without changing the measurement input connections:



- oscilloscope



- multimeter



- harmonic analyser

2.8.3. NAVIGATION KEYS

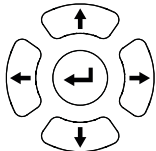

This block of keys is used to move around the menus and in the dialogue boxes; it is also used to move graphic objects (cursor, trigger, memory position...) through the menus.

■ Action of the horizontal keys:

- Horizontal movement through the main menus
- Adjustment of values in the secondary menus
- Horizontal movement in a dialogue box

■ Action of the vertical keys:

- Vertical movement and automatic selection in the secondary menus
- Adjustment of values in the main menus
- Vertical movement in a dialogue box

■ Action of the central "Enter" key:

- Opens a dialogue window from a main menu or a secondary menu
- Validation of the items in a dialogue window

3. OSCILLOSCOPE MODE "THE KEYS"



Pressing this key selects the "Oscilloscope" mode.

3.1. "MENU" KEY

Trigger



displays the main "Trigger" menu

Acquisition



displays the main "Acquisition" menu

Tools



displays the main "Tools" menu

Measurement



displays the main "Measurement/Cursor" menu

Memory



displays the main "Memory" menu

Help



displays the "Help" window

3.2. 3 CHANNEL A, B AND MATH OR MEMORY KEYS

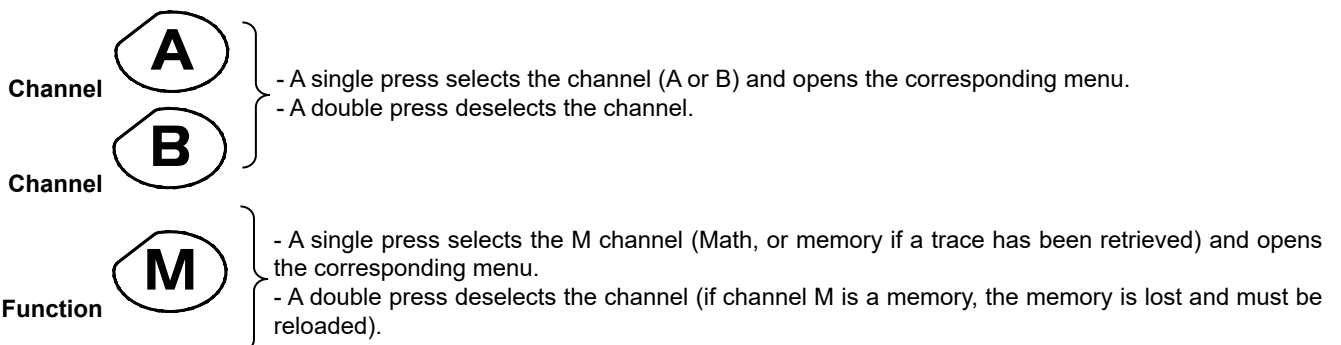

If references are present (§11.1), deselecting the channel permanently erases the associated reference.

3.3. 2 "TIME BASE" KEYS



increases the time base for acquisition up to 200 s.



decreases the time base for acquisition down to 25 ns.

3.4. 2 "SENSITIVITY" KEYS



increases the vertical sensitivity of the last channel selected, up to 5 mV.



decreases the vertical sensitivity of the last channel selected, down to 200 V.



For the M channel, the "sensitivity" key varies the amplitude factor but only if a math channel is validated.

3.5. 2 FUNCTIONAL KEYS



performs an automatic adjustment on channels A and B. The success of each vertical autoset conditions the activation of the channel.



starts or stops acquisition.

4. OSCILLOSCOPE MODE "DISPLAY"

4.1. DISPLAY

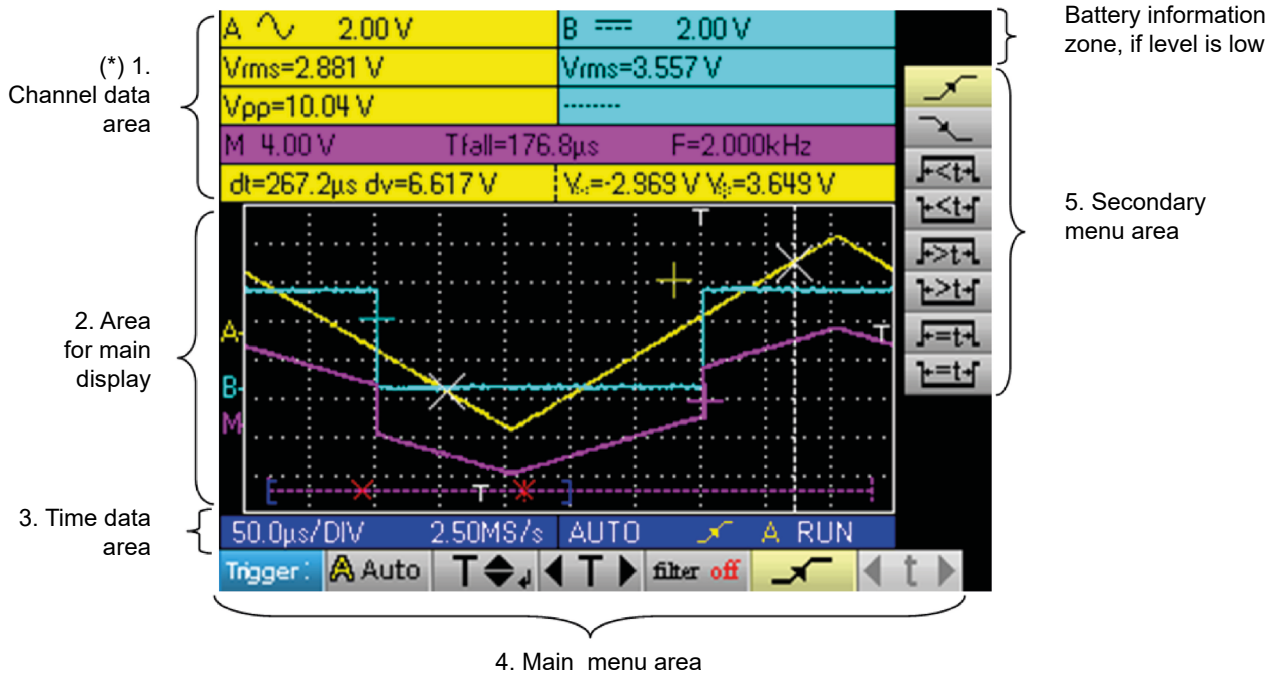

4.2. CHANNEL DATA

A 2.00 V	B 2.00 V
Vrms=2.881 V	Vrms=3.557 V
Vpp=10.04 V	----- (*)
M 4.00 V	Tfall=176.8µs F=2.000kHz
dt=267.2µs dv=6.617 V	Vc=-2.969 V Vp=3.649 V

4.2.1. "MAIN CHANNEL" AREA

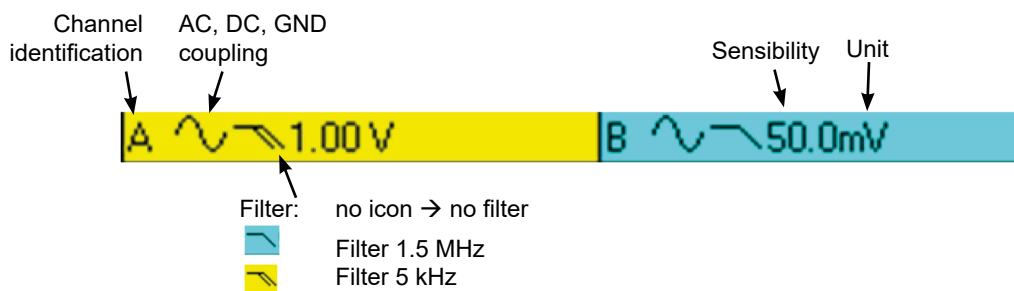

The direct data from channels A and B are displayed in this window:

- Channel identification
- Channel coupling
- Filter
- Channel sensitivity
- Channel unit

(*) If no measurement is selected, if measurement is impossible or if the channel is not validated, the measurement will be replaced by dashes.

4.2.2. "AUTOMATIC MEASUREMENT" AREA

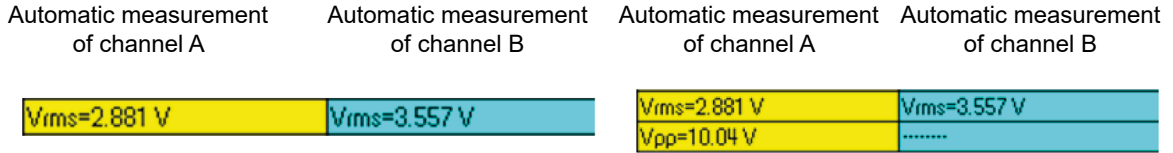

The selected automatic measurements are shown in this window. 1 or 2 measurements per channel can be selected.

4.2.3. "MATH" AREA

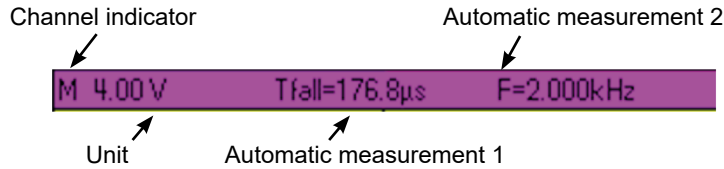

Violet background in "M" channel shows a Math function

4.2.4. "MEMORY" AREA



Green background if "M" channel shows a Memory function

The "M" channel data is shown in this window. This channel can contain a "Math" or a "Memory" function.

In the "M" channel shows a "Math" function, the following data is shown:

- Channel identification
- Sensitivity
- Unit
- Automatic measurements

If the "M" channel shows a "Memory" function, the following data is shown:

- Channel identification
- Sensitivity
- Coupling
- Filter
- Unit
- Automatic measurements

4.2.5. "CURSOR MEASUREMENT" ZONE

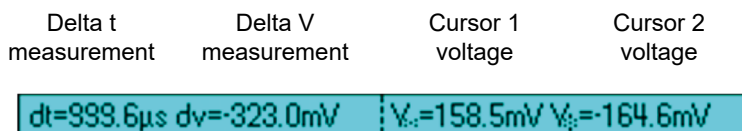

The measurements by cursor are shown in this window. The background colour is identical to that for the channel to which the cursors are attached.

It indicates:

- the horizontal difference (dt) and vertical difference (dv) between the 2 cursors,
- the voltage measurement of the cursors.

4.3. MAIN DISPLAY

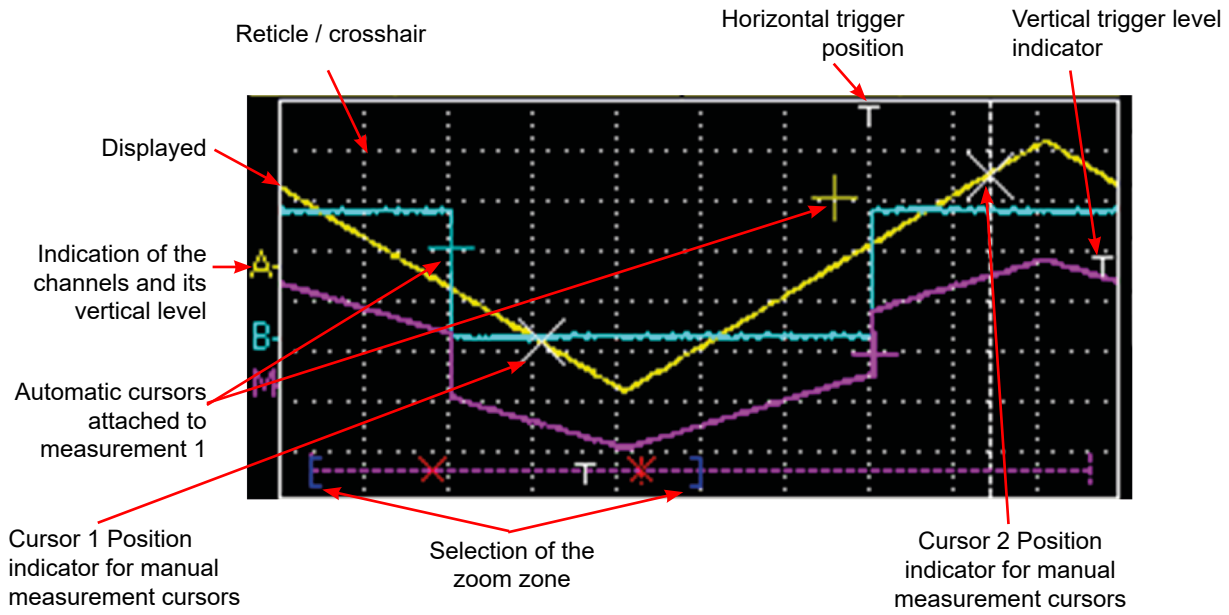

4.4. TIME DATA

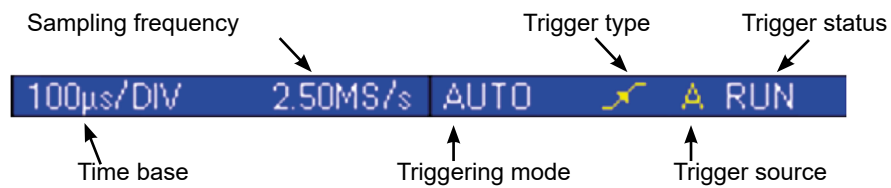

This window is split into two groups:

- A time data group
 - time base
 - sampling frequency

- A trigger data group:
 - triggering mode
 - trigger type
 - trigger source
 - trigger status: RUN, READY, STOP.

5. OSCILLOSCOPE MODE "THE MENUS"

5.1. DISPLAY

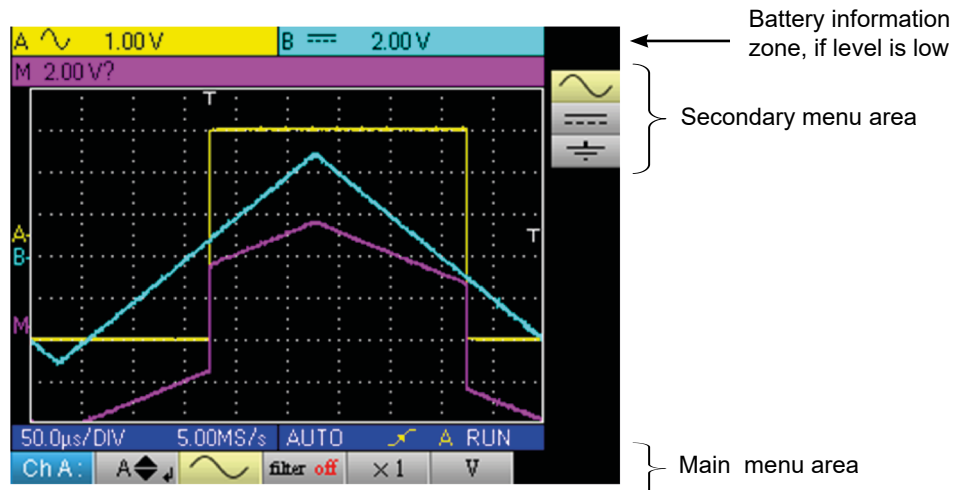

5.2. ORGANIZATION

The menus have two elements:

- a horizontal menu, called "main", located at the bottom of the screen;
- a vertical menu, called "secondary" located to the right of the screen.

5.2.1. MAIN MENU

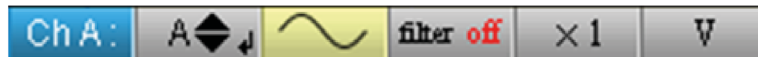

When a tab is selected in the menus, its background turns yellow. When a setting is not available in the current mode, it is greyed out in the main menu and cannot be selected.

5.2.2. SECONDARY MENU



Each tab of the main menu is associated with a secondary menu used to view the different possible settings for the parameter in question.

The two menus automatically disappear and full screen mode is activated after about twenty seconds with no action on the keypad. Pressing the button of the menu displays it again.

5.3. MAIN MENU AREA

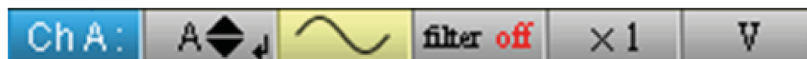

Main menu: displays the oscilloscope configuration

5.4. SECONDARY MENU AREA



Secondary menu: gives access to various parameter settings selected from the main menu.

5.5. NAVIGATION

5.5.1. CLASSICAL NAVIGATION

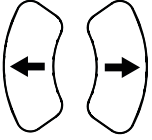

These keys are used to navigate in the main menu.



These keys are used to:



- navigate in the secondary menu,
- set a vertical parameter (see § Vertical settings)



5.5.2. VERTICAL SETTINGS





Vertical settings are recognized by the double arrows  on the main menu tab.



■ To change the value:

- the   keys are used to change the numeric value displayed in the secondary menu and therefore move the graphic object linked to the settings in the direction of the arrows.
- the  key opens the data entry window for direct value entry (see § Activation a dialogue window).

■ To quit the setting:

- The   keys can always be used to navigate the main menu and therefore quit the setting.

5.5.3. HORIZONTAL SETTINGS





The horizontal settings are recognized by the two arrows that  frame the parameter identification on the main menu tab.





■ To change the value: using the





- the   arrows are used to change the value and therefore move the linked graphic object in the direction of the arrows;
- the  key is used to open the direct value entry window (see § Activating a dialogue window).





■ To quit the setting:

- using the   keys, select the quit tab  from the secondary menu.

- the   arrows can then be used to navigate the main menu.

5.5.4. ACTIVATING A DIALOGUE WINDOW



The settings that can be adjusted using a dialogue window can be recognized from the  symbol on the menu tab.

When the tab is selected, pressing the  key opens a dialogue window.



Direct settings entry window

This window is used to directly adjust the numeric value of the parameter in question.

Offset(A) (V)				} Window title, reminder of the setting for the channel and the unit
2.96E-01				
7	8	9		} Numeric keypad
4	5	6	-	
1	2	3	Min	
0	.	E	Max	
				} Validation area

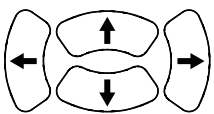

Navigation in the active element window (yellow highlighting).



Validation of the activated key or, in the display area, "Inout / Output" for the selection mode.



The selection mode is used to select several characters from the display area (blue highlighting) using

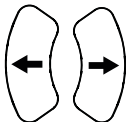

the keys:

The selected characters can be replaced in this way by the value of the button which is validated on the numeric keypad (or deleted using the  button).

When the window opens, the current variable value is completely selected by default.

6. OSCILLOSCOPE MODE - THE CHANNEL "A" OR "B" MENU

6.1. THE CHANNEL "A" OR "B" MENU

A

B

Press one of these two keys.

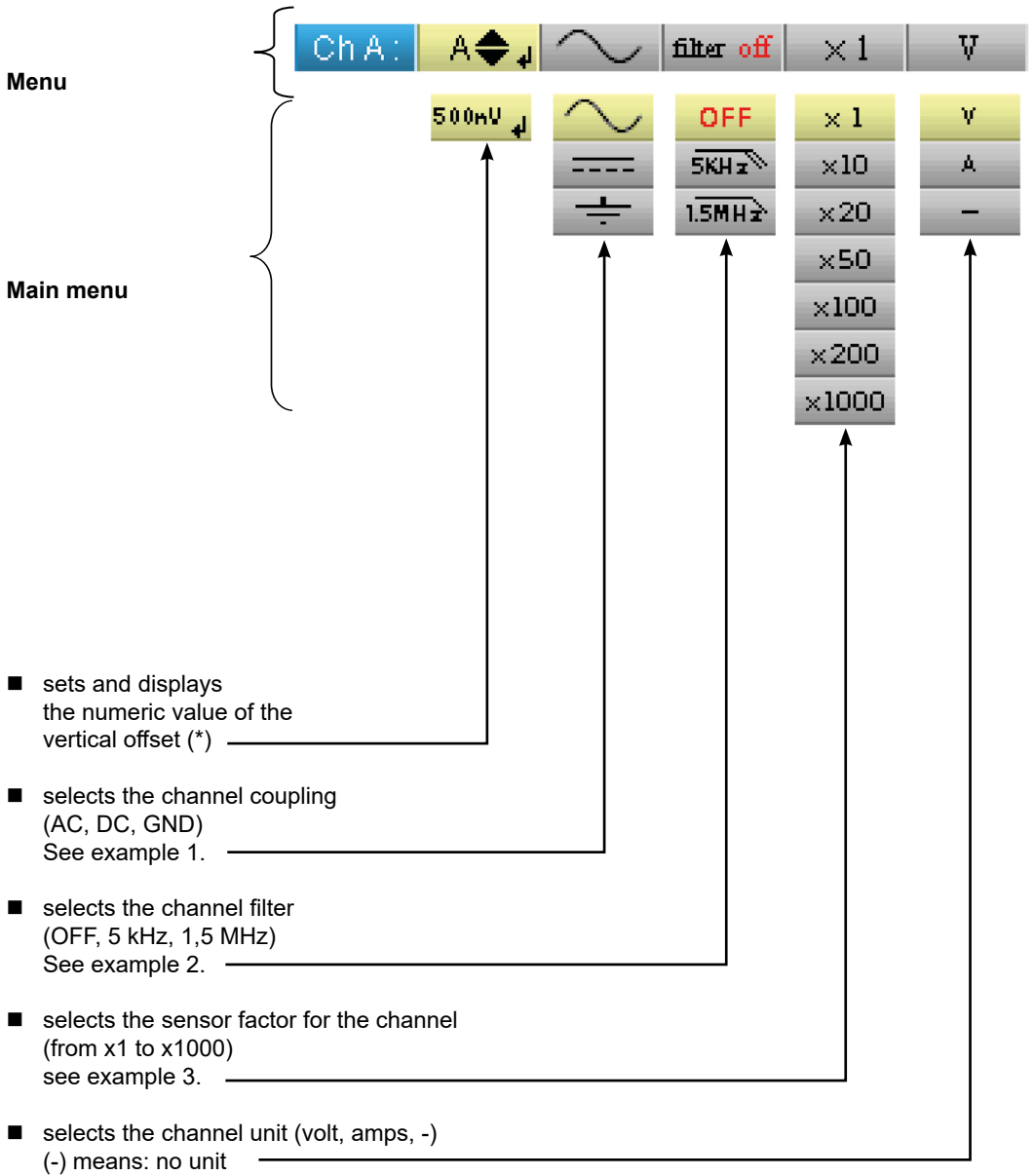

(*) In the 200 mV/div. range, the position shift must not exceed 3 div. out of the 8 div. available, or the measured signal will be deformed (saturation).



Examples :

6.1.1. CHANNEL COUPLING

Injection of a 1 kHz, 2Vpp amplitude sinusoidal signal with an offset of 0.5 V:

- with AC coupling (the DC component is removed):

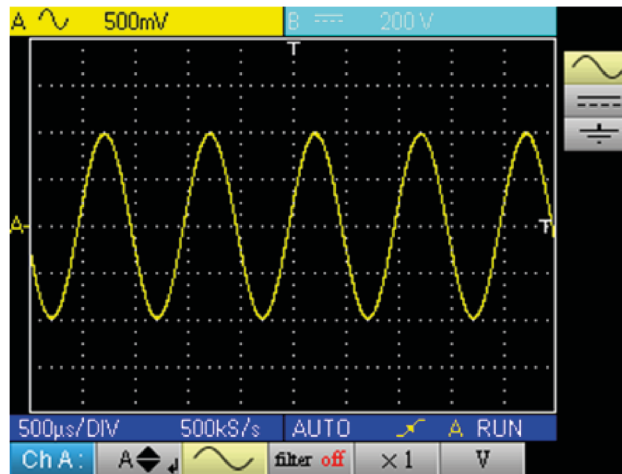

- with DC coupling (the entire signal is measured):

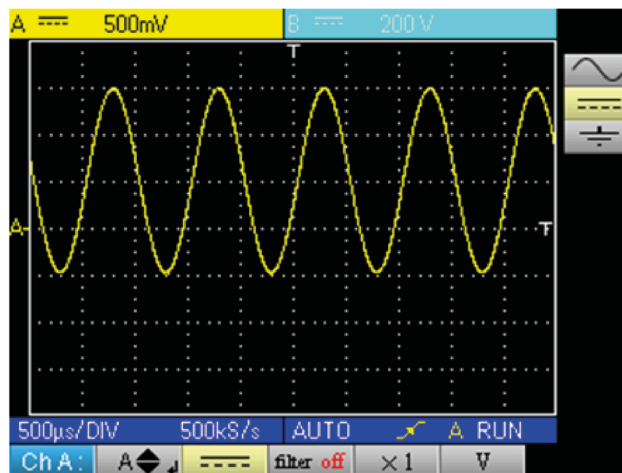

- in GND coupling:

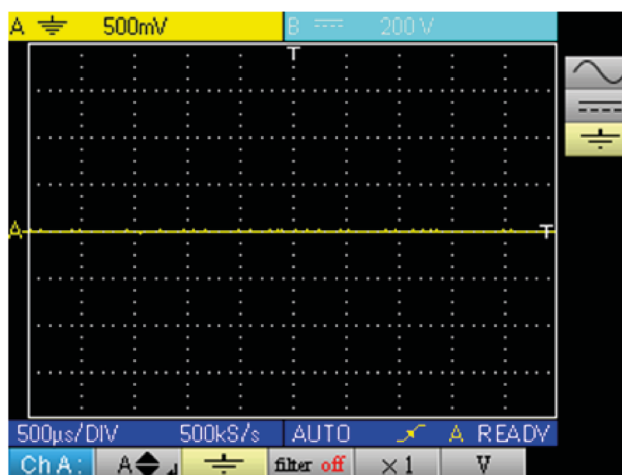

6.1.2. CHANNEL FILTER

Superimposition of 2 sinusoidal signals with a frequency of 100 Hz and 3 MHz, respectively:

- without filter (both signals are sent):

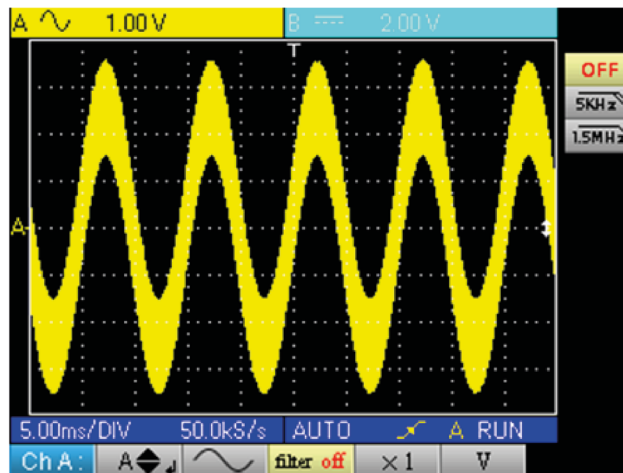

- with the filter 5 kHz low-pass filter (the 3 MHz sinusoidal is cut):

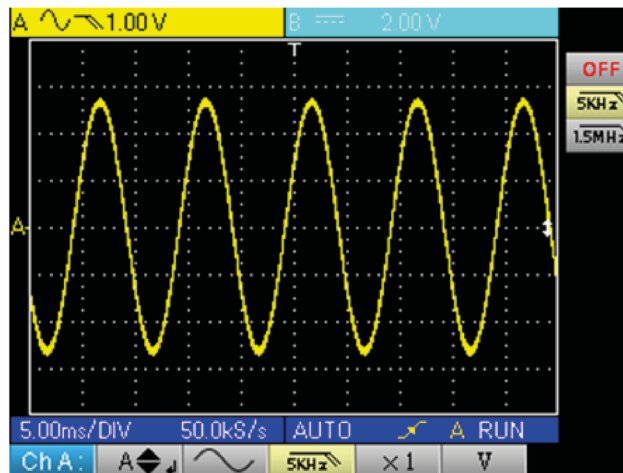

- with the 1,5 MHz low-pass filter (the sinusoidal is partially cut):

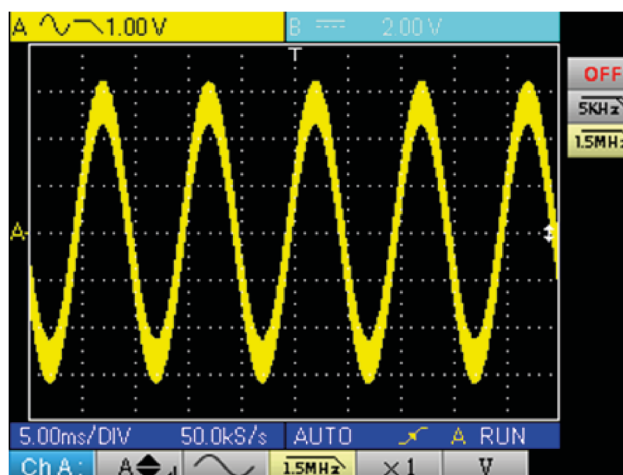

6.1.3. SENSOR FACTOR

Observation of a sinusoidal signal of 2 Vpp and 100 Hz with a x 10 sensor:

- with the factor x 1: the amplitudes and sensitivity are incorrect (factor 10)

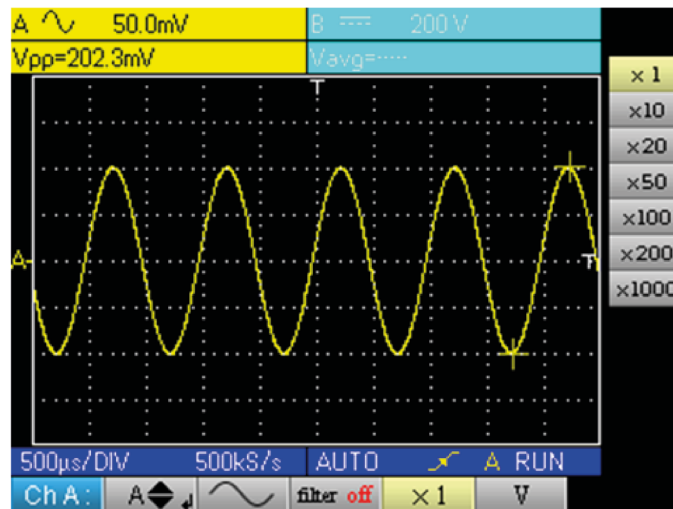

- with the factor x 10: the amplitudes and sensitivities are correct

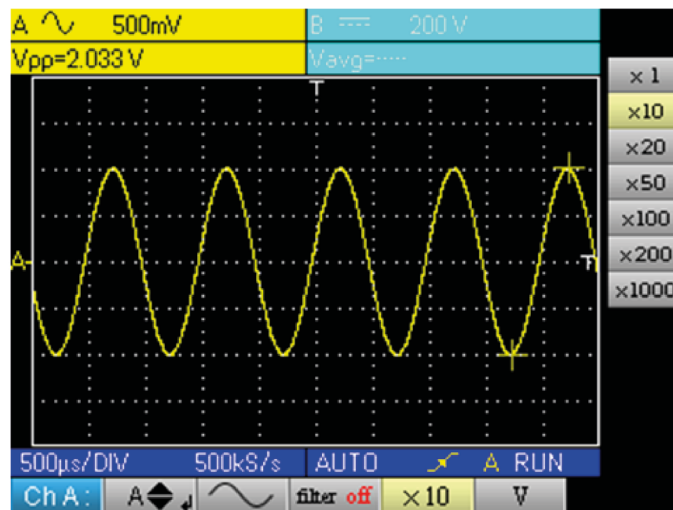

7. OSCILLOSCOPE MODE "THE MATH CHANNEL MENU"

7.1. THE "M CHANNEL" MENU



Press this key.

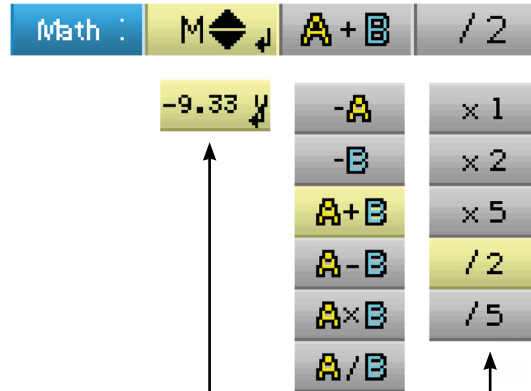

- adjustment of the vertical offset for the Math channel or the stored trace
- selects a mathematical function
- selects the factor for the "Math" function

7.1.1. MATHEMATICAL FUNCTIONS

Warning, the calculation of the mathematical functions is not carried out on physical quantities, but on the signal samples. Be careful in particular to use identical sensitivities on channels A and B for addition and subtraction so that the calculation is meaningful. Thus, the sensitivity of the Math channel is determined as follows:

Operation	Sensitivity Channel A	Sensitivity Channel B	Sensitivity Channel M
- A	X	-	X
- B	-	Y	Y
A + B	X	Y = X Y ≠ X	X X ?
A - B	X	Y = X Y ≠ X	X X ?
A x B	X	Y	XY
A ÷ B	X	Y	X ÷ Y



Example 1: $M = A + B$, addition of a 5 Vpp sine with a 5 Vpp square almost in phase:

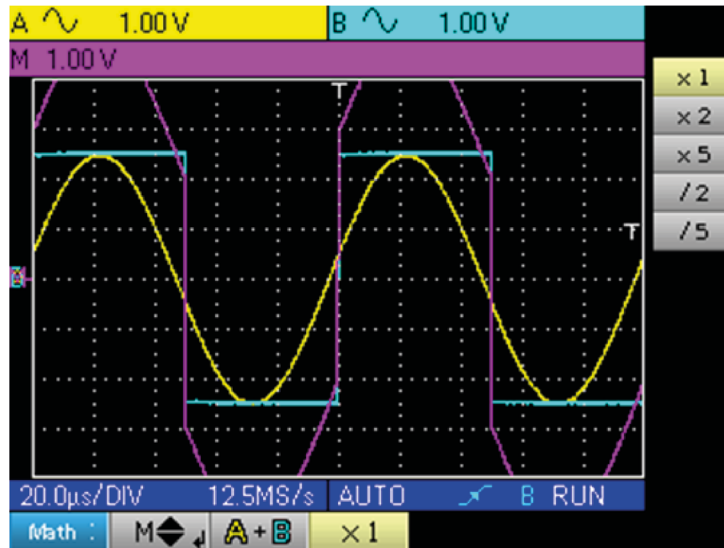

In our example the amplitude of the resulting signal is 10 Vpp. As the sensitivity of channel M is 1 Vpp, it can be seen that the trace overshoots but is contained on the screen by dividing the representation by 2:

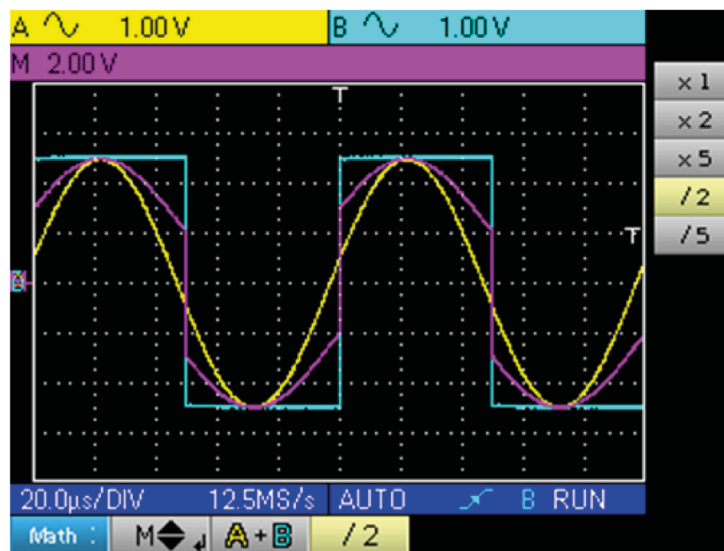

The sensitivity of the M channel becomes 2 V and the amplitude remains at 10 Vpp.



Example 2: $M = A \times B$, multiplication of a 5 Vpp sine and square almost in phase:

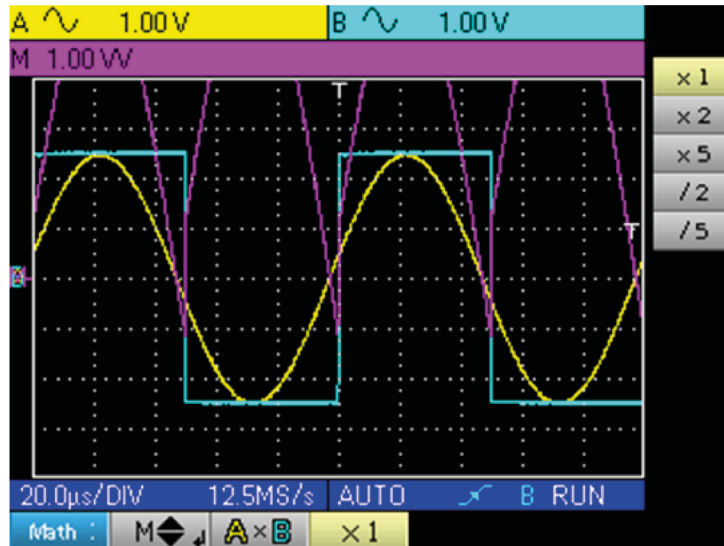

In our example, the peak amplitude of our mathematical function is $2.5 \text{ V} * 2.5 \text{ V} = 6.25 \text{ VV}$. As the channel M sensitivity is 1 VV (with the factor x 1), it can be seen that the trace overshoots and can be corrected by using the /2 coefficient.

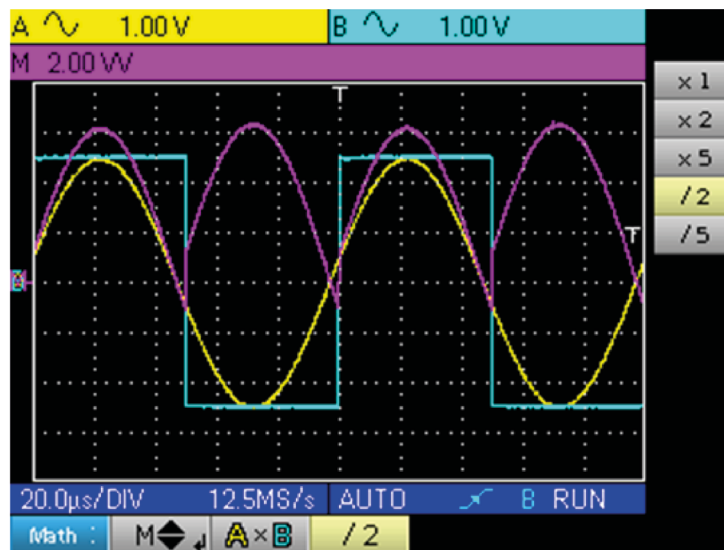

The sensitivity of channel M becomes 2 VV and the peak voltage is $3.125 * 2 \text{ VV} = 6.25 \text{ VV}$.



Example 3: $M = A \div B$, division of a 5 Vpp sine and square almost in phase:

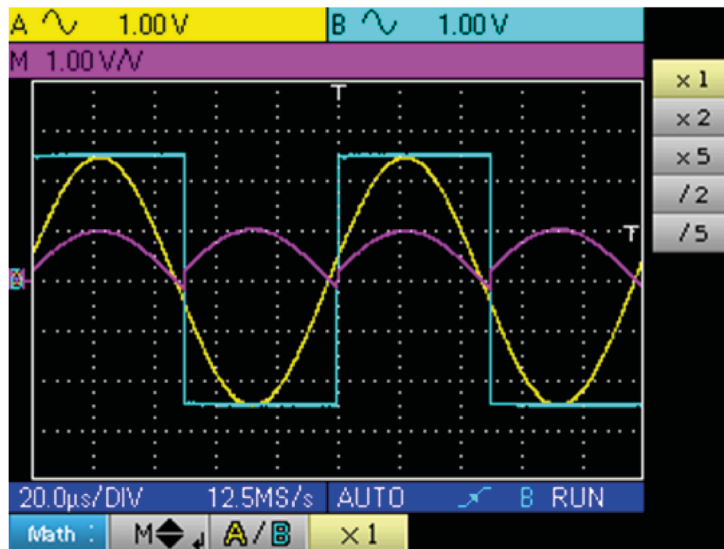

As the positive voltages of signals A and B are equal, the division leads to a positive peak voltage of 1 V/V, and therefore a representation of 1 division on the trace. This can be expanded by choosing factor x 2 or x 5:

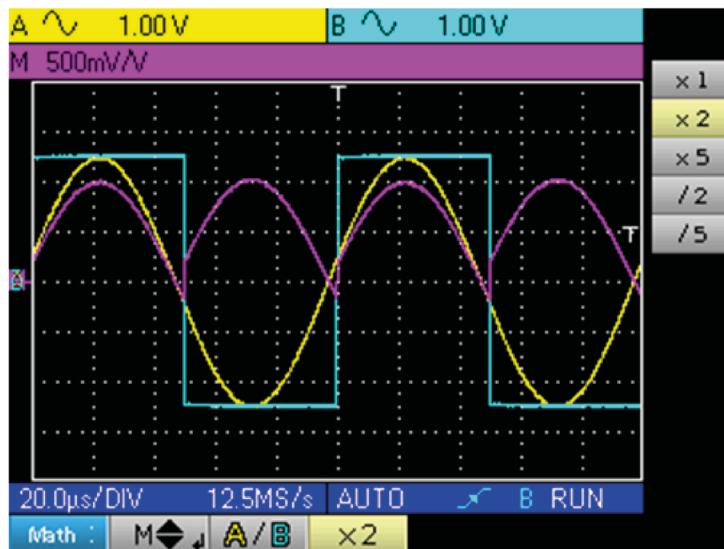

The sensitivity of channel M changes to 500 mV/V and the positive peak amplitude of the trace is 1 V/V.

8. OSCILLOSCOPE MODE "THE TRIGGER MENU"

8.1. THE "TRIGGER" MENU





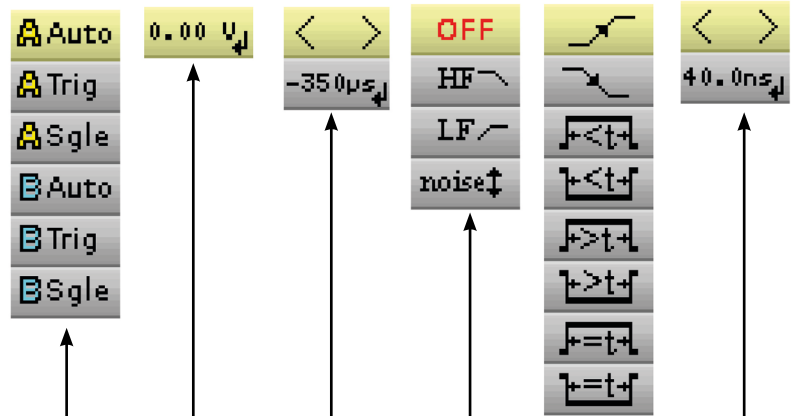



Press this key.



- selects the Trigger source and the trigger mode
- adjusts and displays the vertical trigger level
- sets and displays the event time position in relation to the trace area
< > used to switch to the other menus
- selects the Trigger filter (OFF, HF Reject, LF Reject, Noise, Hysteresis) See examples 1 and 2.
- selects the Trigger type (front or pulse width)
- sets and displays the numeric value for "t", a parameter of the Pulse Trigger, this setting is only possible for the Pulse Trigger
< > Exit tab

8.2. DESCRIPTION

8.2.1. TRIGGER SOURCE AND TRIGGER MODE

Tab	Trigger Source	Triggering mode
	Channel A	automatic
	Channel A	single shot
	Channel A	triggered
	Channel B	automatic
	Channel B	single shot
	Channel B	triggered

- « Single shot » mode:

A single acquisition triggered by pressing the  key opposite is authorised.

- For a new acquisition the triggering circuit must be rearmed by pressing on the key shown opposite.

- « Triggered » mode:

The content of the screen is only refreshed on a triggering event linked to the signals present on the oscilloscope inputs.

In the absence of a triggering event related to the input signals (or the absence of input signals), the trace is not refreshed.

- « Automatic » mode:

The content of the screen is refreshed, even if the trigger level is not detected on the signals on the inputs. In the presence of a triggering event, the screen refresh is managed as in "triggered" mode.

8.2.2. TRIGGER TYPE

 Rising edge trigger

 Falling edge trigger

 Pulse trigger less than "t", with positive pulse

 Pulse trigger less than "t", with negative pulse

 Pulse trigger greater than "t", with positive pulse

 Pulse trigger greater than "t", with negative pulse

 Pulse trigger equal to "t", with positive pulse

 Pulse trigger equal to "t", with negative pulse

8.3. EXAMPLES

8.3.1. TRIGGER FILTER

Display of a 1 kHz sine with noise (Acquisition Envelope ON)

- without trigger filter (we trigger on the edge of the 1 kHz signal but, depending on the noise value, we trigger on the rising or falling edge):

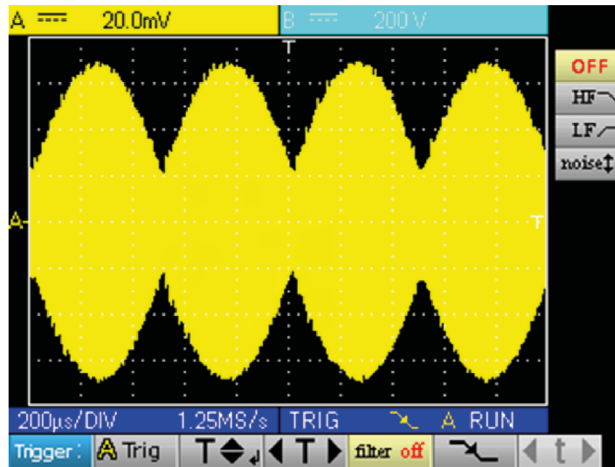

- with the HF reject filter (the noise is filtered, we trigger on the 1 kHz sine):

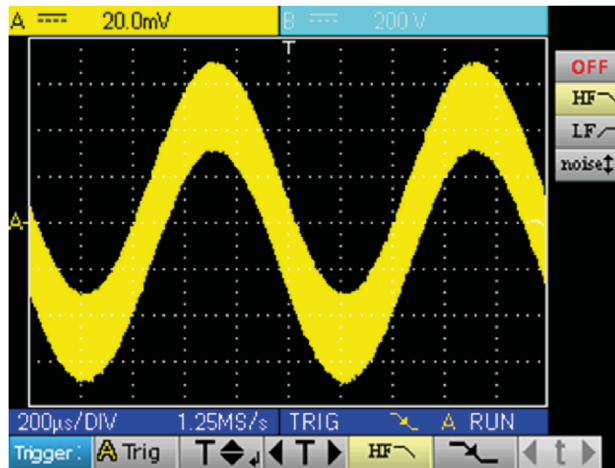

- with the LF reject filter (the 1 kHz signal is filtered, we trigger on the noise → not effective in this case):

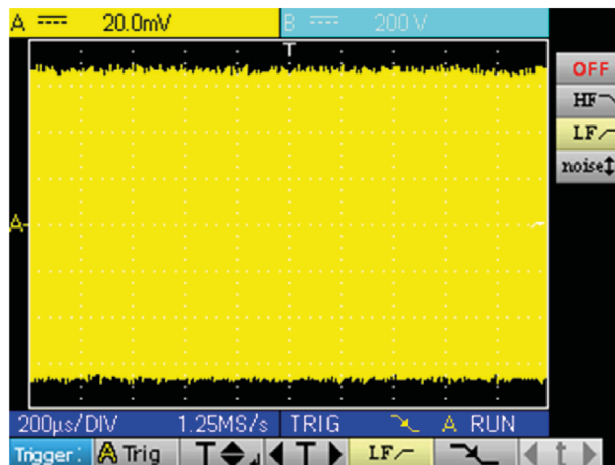

- with the Noise filter (the trigger hysteresis changes to 3 div., we trigger on the 1 kHz sine):

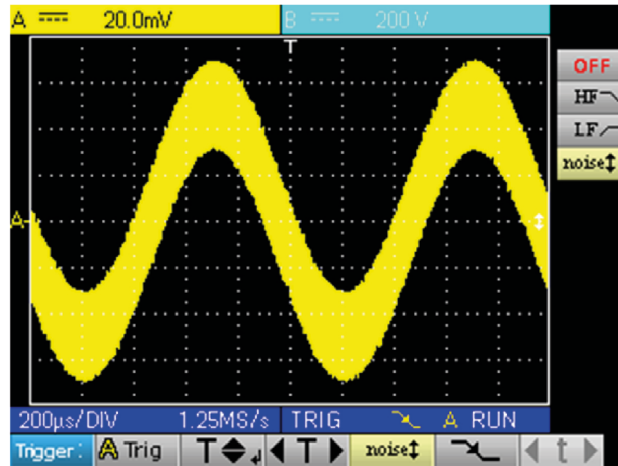

8.3.2. OTHER LF REJECT FILTER EXAMPLE

Observation of a slow 10 Hz sine on which peaks show every 200 ms (PkDet activated)

- Case of noise: (we only trigger on the sine edge as it is not easy to zoom on the peaks)

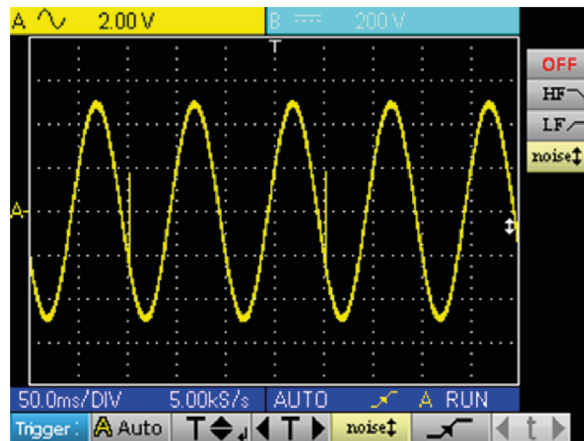

- LF reject case: (we remove the 10 Hz signal and can trigger on the peak and zoom)

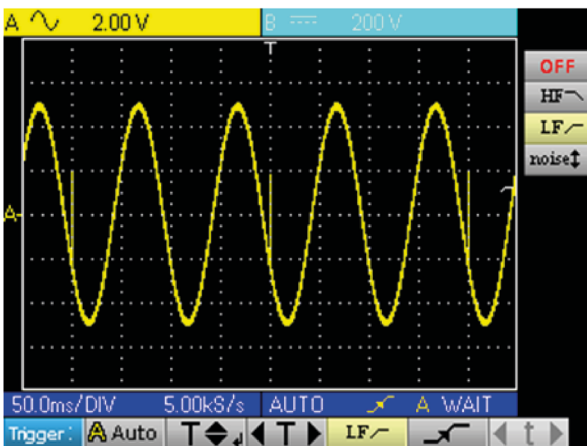

- By changing the time base, the peaks can be observed correctly:

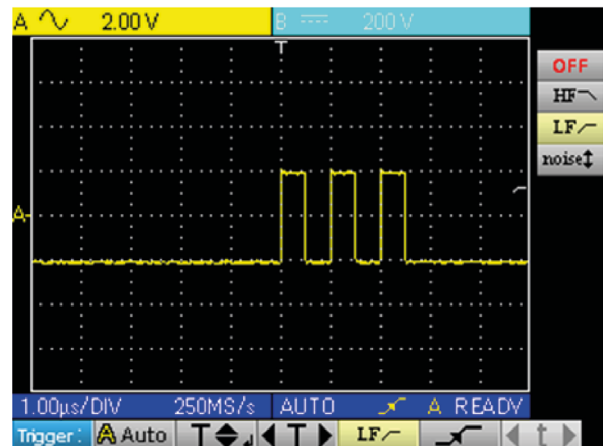



This can also be achieved without a filter, but by selecting triggering on a pulse width of less than $1\ \mu\text{s}$:

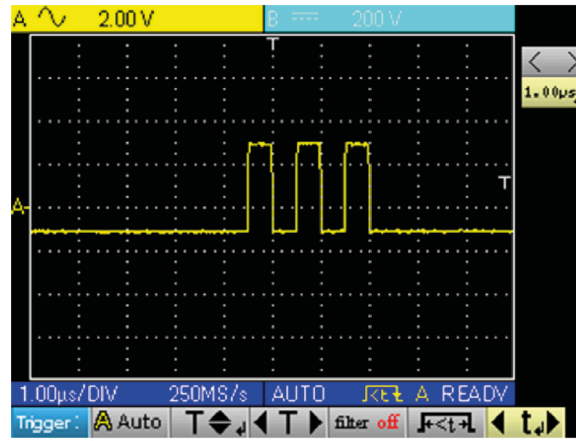

9. OSCILLOSCOPE MODE "THE ACQUISITION MENU"

9.1. THE "ACQUISITION" MENU

Acq

Press this key.

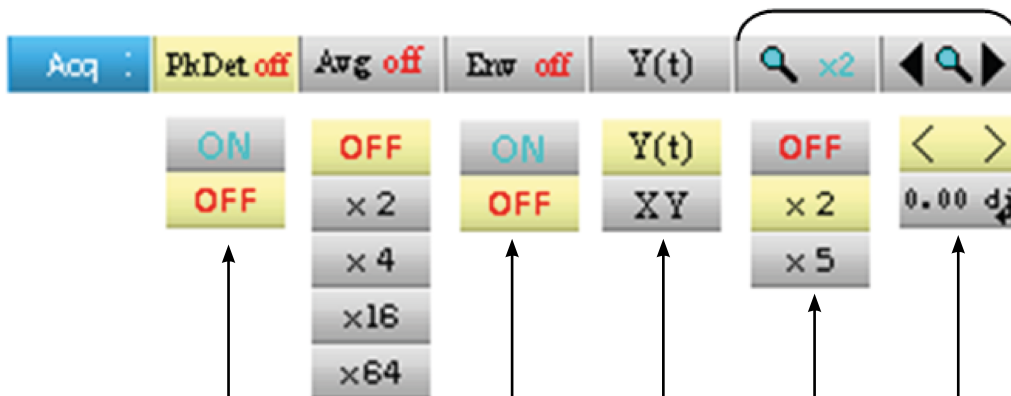

- activates or deactivates the "Peak detection" menu
See example 1
- selects or deactivates averaging function factor
See example 2
- activates or deactivates the "Envelope" mode
See example 3
- selects the time or "XY" mode
In the "XY" mode, "CHA" is used as the X-axis and "CHB" as the Y-axis. The "M" channel cannot be represented using "XY" mode. The cursors cannot be activated in this mode.
- selects or deactivates the "Zoom" factor
- moves the time-based zoom window
(this adjustment is only possible if a zoom is active).

< > Exit tab

9.2. EXAMPLES

9.2.1. PkDet acquisition

Observation of rapid pulse combs with a low repetition frequency.

- without PkDet (the repetition frequency of the combs gives an inappropriate sampling frequency for viewing the signal, so there are missing combs):

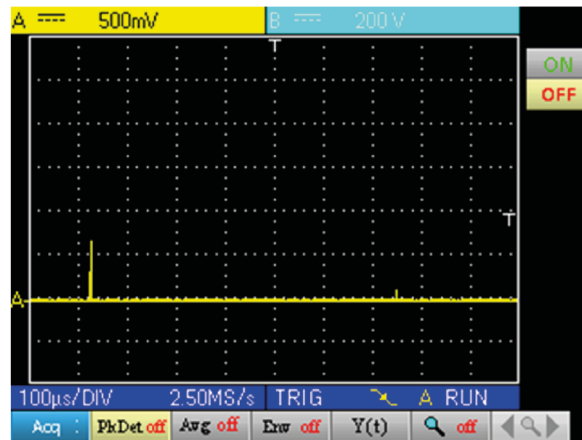

- with PkDet (the detection of the min and max obtained between two sampling steps makes it possible to view all the combs):

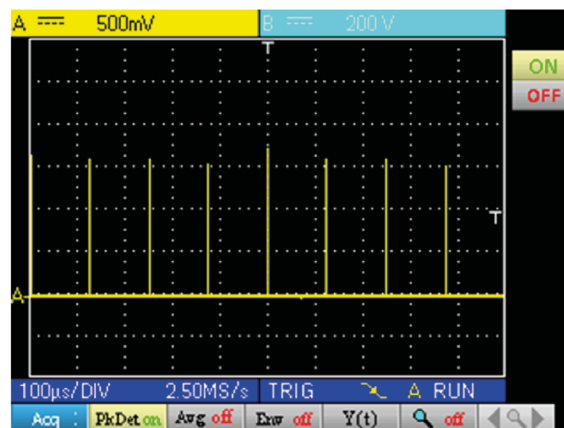

Peak detection deactivates ETS (Equivalent Time Sampling) reconstruction of a repetitive trace. Sampling is real-time for time bases $\leq 2.5 \mu\text{s}/\text{div}$.

9.2.2. ACQUISITION AVERAGING

Observation of a 1 kHz sine with noise. Prior to averaging make sure that the trace is stable. In our example the Noise filter from the Trigger menu is activated.

- without averaging:

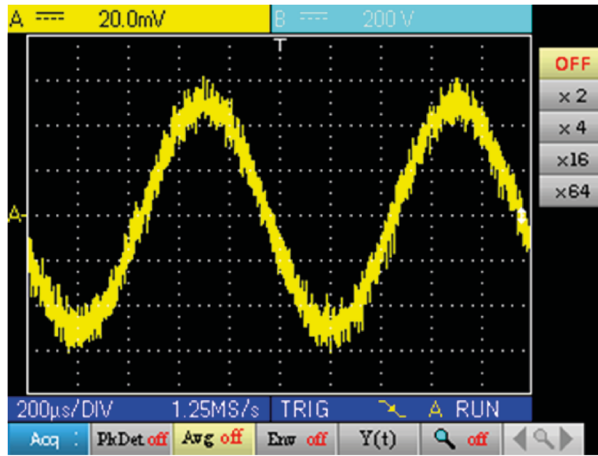

- with x 4 averaging (the noise is reduced) :

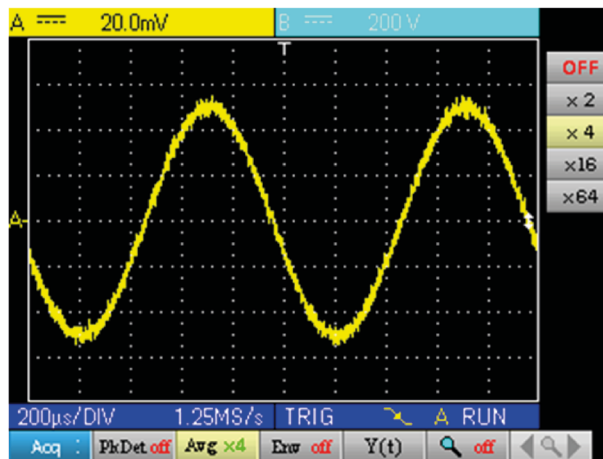

- with x 64 averaging (the noise has almost disappeared) :

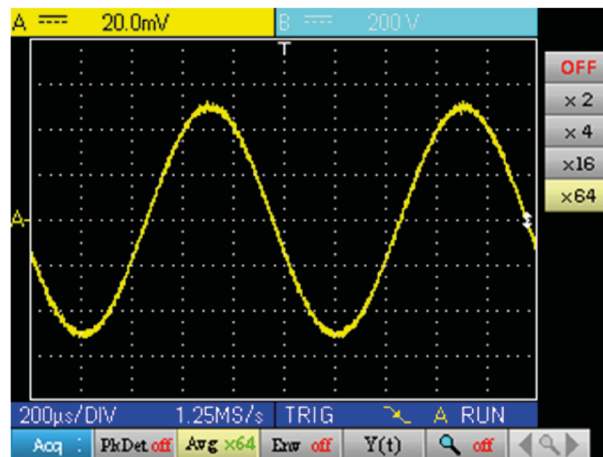

9.2.3. ENVELOPE ACQUISITION

Observation of a sinusoidal signal with amplitude modulation.

- without envelope (an acquisition is viewed at each triggering):

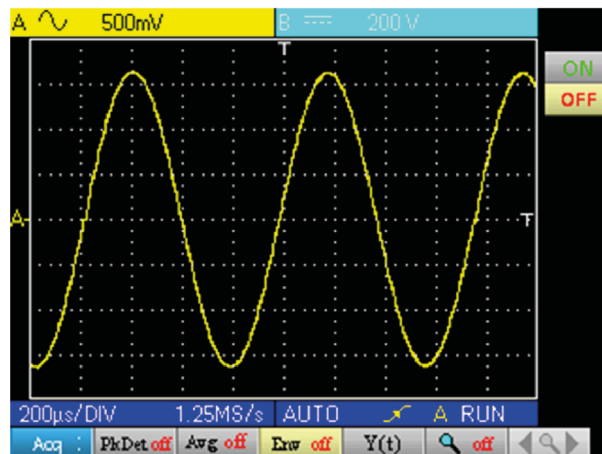

- with envelope (an acquisition is displayed at each triggering):

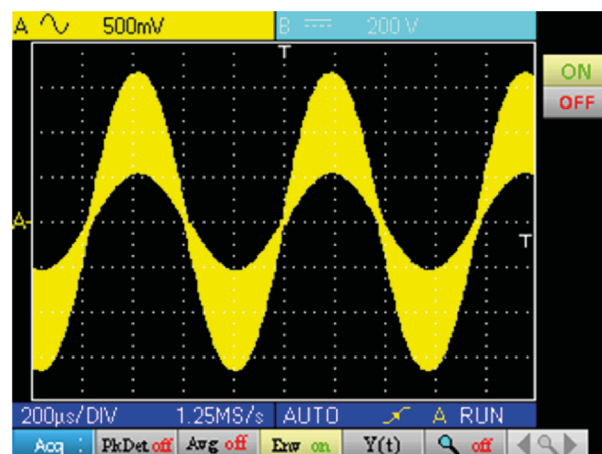

10. OSCILLOSCOPE MODE "THE MEASUREMENT MENU"

10.1. THE "MEASUREMENT" MENU



Press this key.

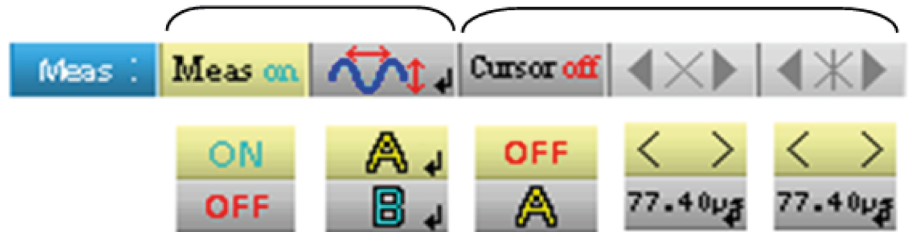

- activates or deactivates automatic measurement display
- used to open the configuration window for automatic measurements on the channel in question (by pressing the key opposite) (*)
- activates or deactivates cursor measurements
- sets and displays the numeric value of cursor 1 position (**)
- sets and displays the numeric value of cursor 2 position (**)

(*) This setting is only possible if the automatic measurement display is active.

(**) This setting is only possible if the cursors are active.

10.1.1. DESCRIPTION OF THE CONFIGURATION WINDOW FOR AUTOMATIC MEASUREMENTS

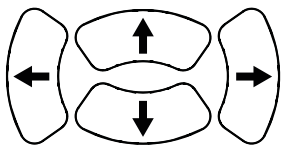
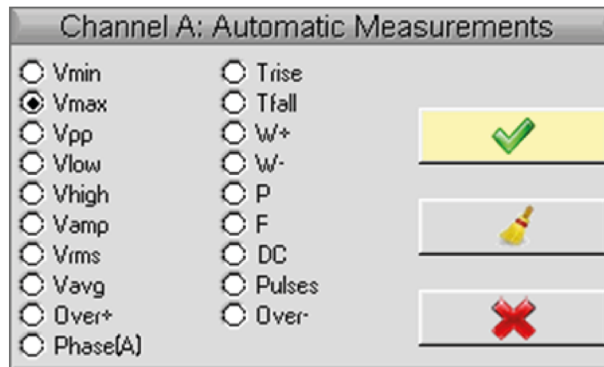

Movement of the selection in the window



Validation of the selection

NAME	MEASUREMENT DESCRIPTION	AUTOMATIC CURSOR INDICATION
Vmin	minimum peak voltage	Vavg and Vmin
Vmax	maximum peak voltage	Vavg and Vmax
Vpp	peak-to-peak voltage	Vmin and Vmax
Vlow	established low voltage	Vavg and Vlow
Vhigh	established high voltage	Vavg and Vhigh
Vamp	amplitude	Vlow and Vhigh
Vrms	root-mean-square voltage	Vrms and measurement interval
Vavg	average voltage	Vavg and measurement interval
Over+	positive offset	Vmin and Vmax
Trise	rise time	points used for the calculation
Tfall	fall time	points used for the calculation
W+	width of positive pulse (at 50% Vamp)	Vavg and points used for the calculation
W-	width of negative pulse (at 50% Vamp)	Vavg and points used for the calculation
P	period	Vavg and points used for the calculation
F	frequency	Vavg and points used for the calculation
DC	duty cycle	Vavg and points used for the calculation
Pulses	number of pulses	Vavg and points used for the calculation
Over-	negative overshoot	Vmin and Vmax
Phase (A)	reference channel B, "channel A phase shift"	Vavg and period used for the calculation
Phase (B)	reference channel A, "channel B phase shift"	Vavg and period used for the calculation



1 or 2 automatic measurements per channel can be selected. The automatic cursors are assigned to the last selected measurement which is displayed in the first position on the screen. When the measurement is possible, the automatic cursors provide an additional indication, see the table above.

10.1.2. MEASUREMENT CONDITIONS

- The measurements are made on the entire depth of the acquisition.
- Any modification of the signal causes an update of the measurements. These are refreshed at the same rhythm as the acquisition.
- The accuracy of the measurements is optimal if two complete periods of the signal are displayed.

10.1.3. PRESENTATION OF AUTOMATIC MEASUREMENTS

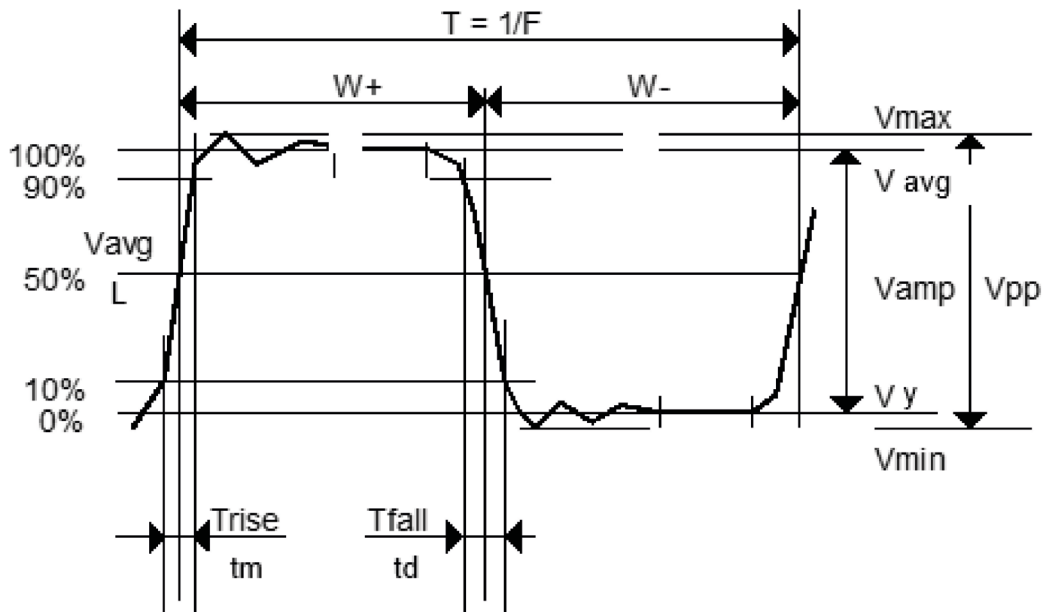

- Positive overshoot = $[100 * (V_{max} - V_{high})] / V_{amp}$
- Negative overshoot = $[100 * (V_{max} - V_{low})] / V_{amp}$

- $V_{rms} = \left[\frac{1}{n} \sum_{i=0}^{i=n} (y_i - y_{GND})^2 \right]^{1/2}$

- $V_{avg} = \frac{1}{n} \sum_{i=0}^{i=n} (y_i - y_{GND})$

YGND = value of the point representing zero Volts

10.1.4. PHASE MEASUREMENT

Automatic measurement of one trace's phase compared with the other trace.

No phase measurements are possible on the M channel.

The choice of the measurement configuration window (channel A or B) on which the phase measurement is selected conditions the reference channel for the phase-shift measurement.

If the selection is made from the channel A window: channel B becomes the reference channel and the oscilloscope displays the phase shift of channel A in relation to channel B.

11. OSCILLOSCOPE MODE "THE MEMORY MENU"

11.1. THE "MEMORY" MENU



Press this key.

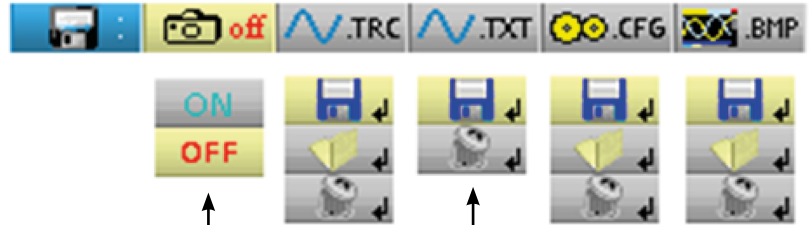

- activates or deactivates the reference display
See example
- manages stored traces (.trc)
- manages stored traces (.txt)
The .txt traces cannot be reloaded on the HandScope but can be used in Spreadsheet software.
- manages memorised configurations (.cfg)
The .cfg files are specific to the HandScope and are not compatible with the brand's other instruments.
- manages memorised screenshots (.bmp)

11.1.1. DEFINITION OF THE COMMON ICONS



gives access to the window for recording a trace, a text trace or a stored configuration or screenshot.



gives access to the trace, configuration or screenshot recall window.



gives access to the window for deleting a trace, configuration, text trace, stored configuration or screenshot.

The file name is generated automatically (e.g. trace_01.txt, etc.).

11.1.2. STORAGE CAPACITY

The memory's capacity is 2 MB (500 kb of which used by File System) and it can be used to store traces, screenshots, configurations and measurement files.

The file names are generated automatically by incrementing the file index from 00 to 99 (e.g.: trace-00.TXT, trace-01.TRC, setup-03.CFG, screen-10.BMP, meter-20.TXT ...).

When the memory is full the message "Error: Memory Full!" appears.

There are 3 possible solutions:



- delete the files one by one using the "Memory" option (→ data is lost).
- transfer the files to a PC via SX-METRO or remote commands (see programming instructions).
- completely reinitialise the memory

 **Warning ! All files will be lost.**

Erasing Memory



(40 Seconds)

1. Turn off the instrument and press  and .
2. While keeping the keys pressed down, press on  and wait for the symbol opposite to appear.
3. The deletion takes about forty seconds.

11.2. EXAMPLE

11.2.1. TRACE REFERENCE

Observation of a sinusoidal signal with amplitude modulation.

The reference signal appears in light yellow. The amplitude signal is no longer the same as the reference.

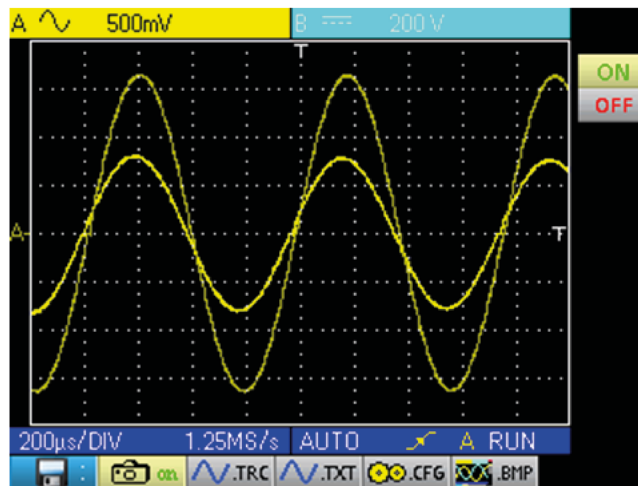

A reference memory is volatile; it is lost when the instrument is powered off, or when the channel or reference is deactivated.

11.3. DESCRIPTION

11.3.1. RECORDING MANAGEMENT

- Of a .trc trace
- Of a .txt trace
- Of a .cfg configuration
- Of a .bmp screenshot

Example :

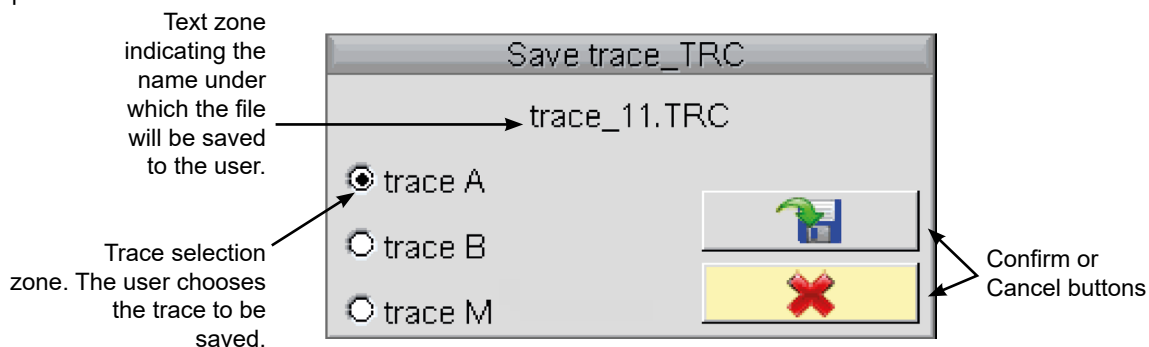

11.3.2. RECALL MANAGEMENT

- Of a .trc trace (the trace is loaded instead of the Math channel)
- Of a .cfg configuration
- Of a .bmp screenshot

Example :

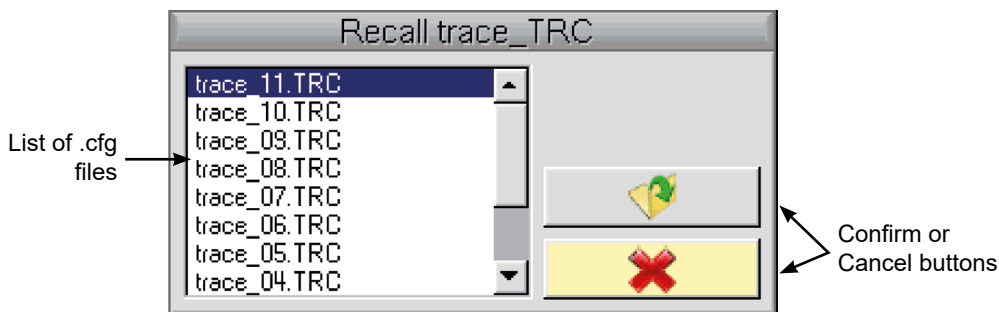

11.3.3. DELETION MANAGEMENT

- Of a .trc trace
- Of a .txt trace
- Of a .cfg configuration
- Of a .bmp screenshot

Example :

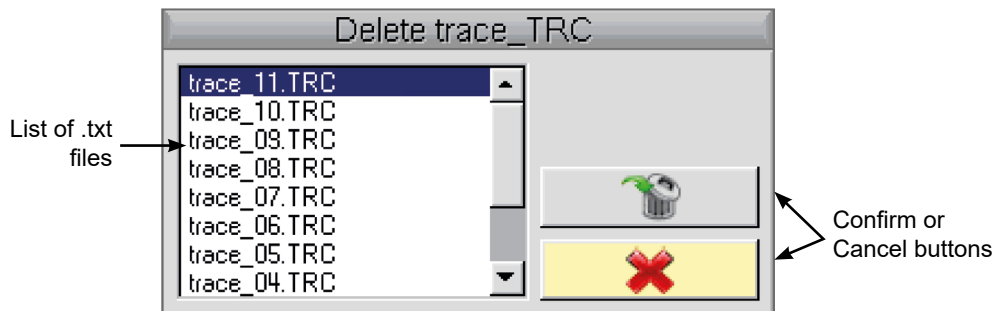

11.3.4. RECOVERY OF THE DATA

The SX METRO software can be used to recover the data of the Oscilloscope mode on a PC.

12. OSCILLOSCOPE MODE "THE TOOLS MENU"

12.1. THE "TOOLS" MENU



Press this key. This menu is the same in "Multimeter" and "Harmonic analyser" modes.



- selects the language of warning or help messages:



- opens the "Rs / USB Information" window:

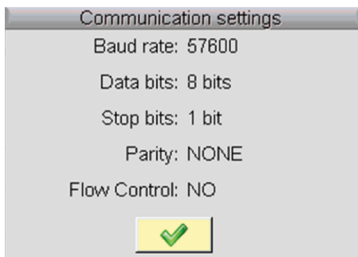

- opens the "About ..." window:

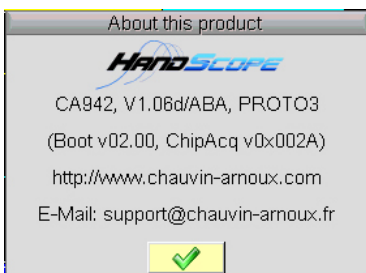

12.1.1. THIS WINDOWS GIVES INFORMATION ABOUT:

- the instrument name, the software / hardware version and the serial number
- the startup and acquisition programme versions
- the website to visit to obtain news on the METRIX instrument range,
- the customer support E-mail address to obtain answers to your questions concerning the instrument.

13. OSCILLOSCOPE MODE "THE HELP KEY"

13.1. THE "HELP" KEY



Press this key to activate / deactivate the integrated help function.
In all modes it displays a help window for the current menu.

Example :

Main title of the current help

A pointer placed opposite the lab of the secondary menu for which help is needed.

Pointer placed opposite the lab of the main menu.

Scroll bar; its position can be changed by using the vertical sensibility keys:



14. MULTIMETER MODE "THE KEYS"

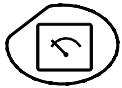

Pressing this key selects the "Multimeter" mode; 2 independent 8,000-count digital multimeters are available.

14.1. 6 "MENU" KEYS

Trigger



inactive in "Multimeter" mode.

Acquisition



inactive in "Multimeter" mode.

Tools



displays the main "Tools" menu, identical to the Oscilloscope mode

Measurement



inactive in "Multimeter" mode.

Memory



displays the main "Memory" menu

Help



displays the "Help" window, identical to the Oscilloscope mode

14.2. 3 KEYS : CHANNEL A, B AND MATH



Channel

A single press selects channel "A" (or "B") and shows the corresponding menu.



Channel

Pressing twice deselects the channel.



Function

inactive in "Multimeter" mode.

14.3. "TIME BASE" KEYS



increases the recording time in the viewing window.



decreases the recording time in the viewing window.

14.4. 2 "SENSITIVITY" KEYS



increases the range of the last selected channel.



decreases the range of the last selected channel.

14.5. FUNCTIONAL KEYS



inactive in "Multimeter" mode.



the RUN/ HOLD key activates/ deactivates the Hold mode, which freezes the screen.

15. MULTIMETER MODE "DISPLAY"

15.1. DISPLAY

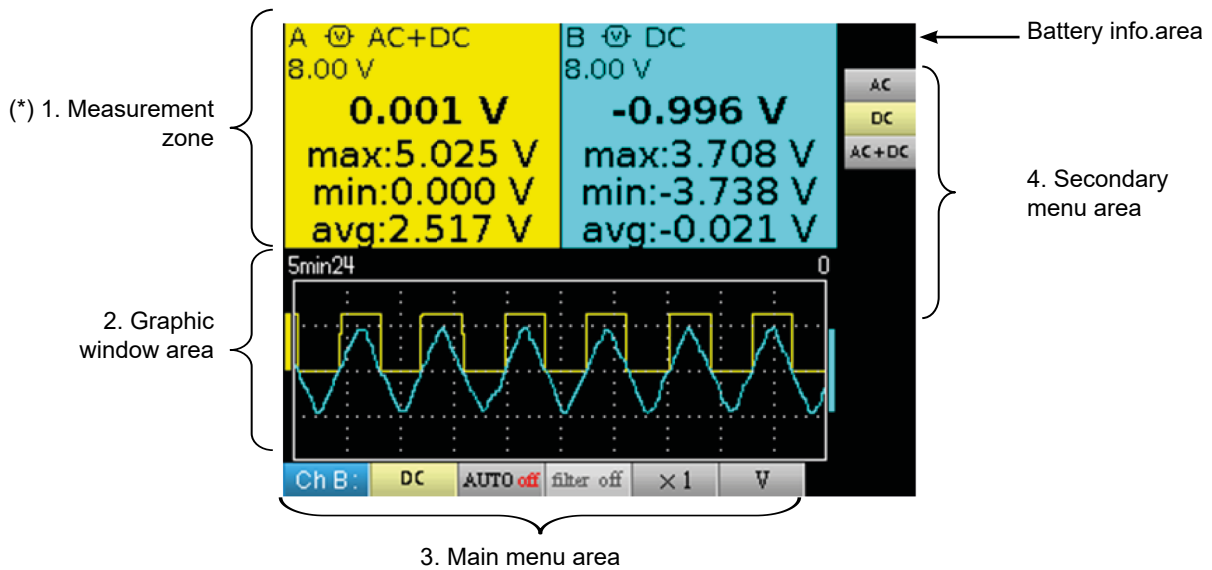

(*) If the measurement is not possible, dotted lines will be displayed. If the channel is not validated the measurement will be replaced by "-x-".

15.2. MEASUREMENT ZONE

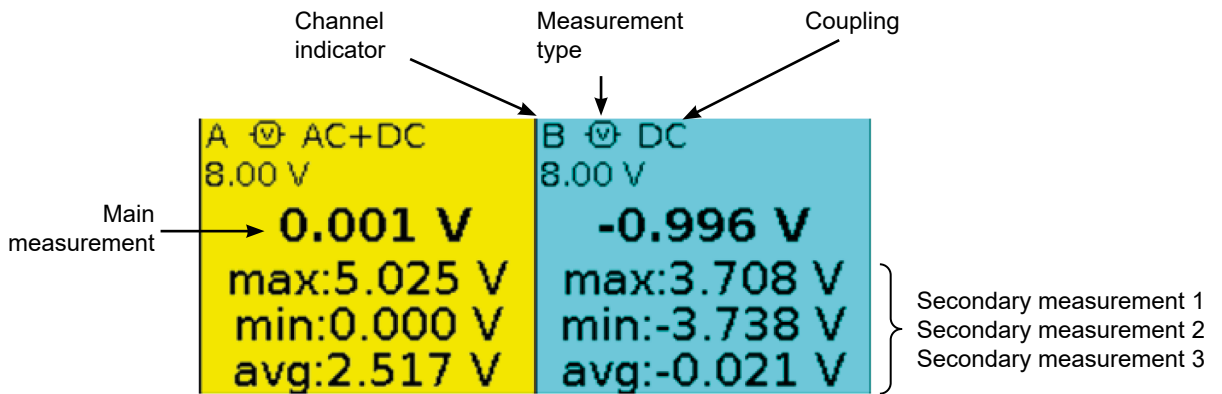

The direct data from channels A and B are displayed in this windows:

- Channel indicator
- Coupling
- Filter
- Measurement type
- Main measurement
- Secondary measurement 1
- Secondary measurement 2
- Secondary measurement 3

15.3. GRAPHIC WINDOW AREA

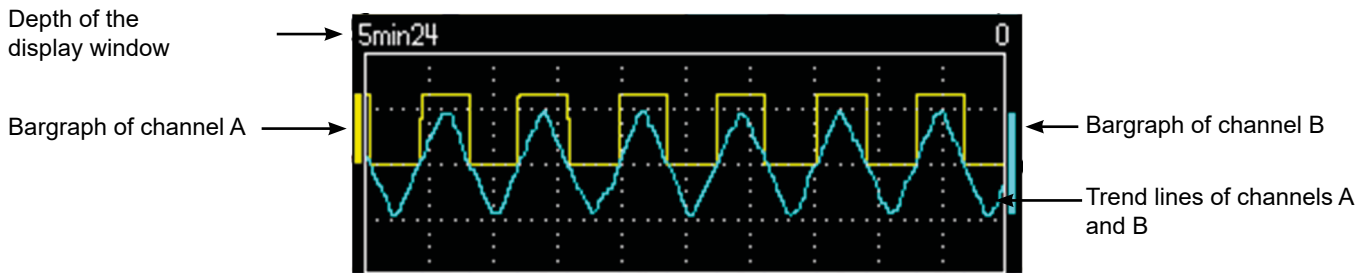

This window shows the measurement changes as a function of time, i.e.:

- the trend curves for the main measurement on each channel
- the reticle
- the operation duration
- a bargraph per channel

15.3.1. TREND CURVE

The trend curve is displayed over 270 points.

15.3.2. OBSERVATION DURATION

The depth of the window represents the observation duration: 2700 measurements are used.
Possible settings: 5'24", 15', 30', 1hr, 6hrs, 12hrs, 24hrs, 1 week, 1 month.

15.3.3. BARGRAPH

These bargraphs show the min and max measured values.



A range change reinitialises the bargraph at deletes the measurement trend curve.

15.4. MAIN MENU AREA

15.5. SECONDARY MENU AREA

16. MULTIMETER MODE "THE MEASUREMENT MENU"

16.1. THE "MEASUREMENT" MENU



Press this key.

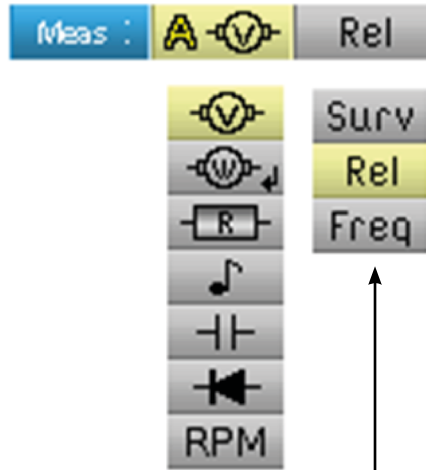

- selects the main measurement on channel "A"
- selects the secondary measurement displayed on the channels



Channel "B" is assigned to voltage measurement, when possible.

16.2. DESCRIPTION

16.2.1. CHANNEL "A" MAIN MEASUREMENT

- Amplitude measurement
- Active power measurement
- Ohmmeter
- Continuity
- Capacitance meter
- Component test
- Rotation speed measurement (specific sensor CA 1711)

16.2.2. POWER MEASUREMENT AND DIALOGUE WINDOW FOR "MEASUREMENT SELECTION"

When selecting  active power measurement, pressing on  displays the window below. You can thus choose the measurement type:

- Single-phase
- Balanced three-phase without N
- Balanced three-phase with N

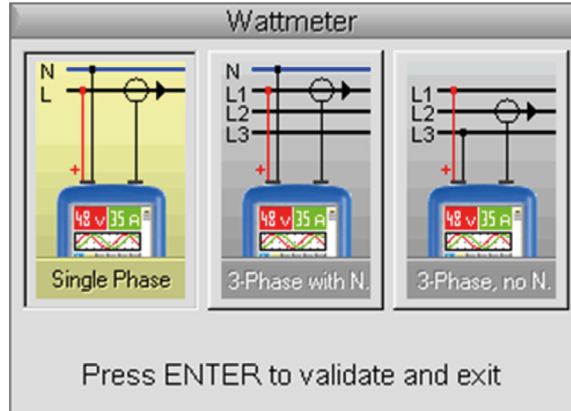

16.2.3. DISPLAY OF THE POWER MEASUREMENT AND FORCED TABS

The power measurement imposes the following settings:

- Channel A unit: V (volt)
- Channel B unit: A (ampère)
- Channel A and B coupling: AC

Example : By default the power covers the measurement of channel A; pressing the **A** key is used to view the measurement of channel A, the power then covers the measurement of channel B and vice versa with the **B** key.

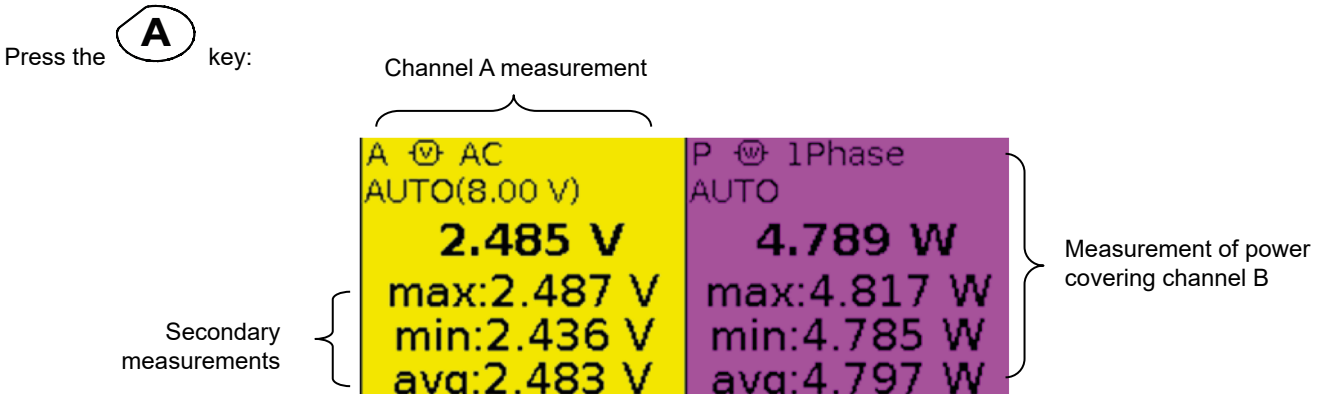
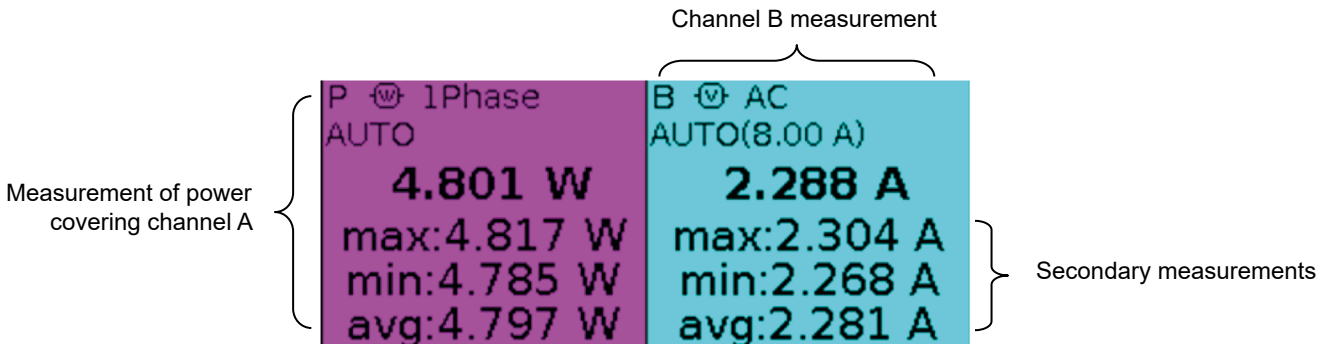

16.2.4. SECONDARY MEASUREMENT

Selects the secondary measurement displayed on the channels:

Surv activates the secondary monitoring measurement. This comprises three measurements:

- min → the minimum measured value
- max → the maximum measured value
- avg → the average value since the last reset

Rel activates the relative secondary measurement. This comprises three measurements:

- rel → the difference between actual value and reference value
- ref → the reference value
- Δ → the difference in %

Freq activates the secondary frequency measurement. If N is selected, the PF (Power Factor) measurement is displayed.



The choice of secondary measurement is applied to all channels.
The secondary measurement validated by default is frequency.



You can reset the secondary monitoring or relative measurements by:



- pressing  when the active main menu is the secondary measurement choice menu,
- by temporarily changing the secondary measurement,
- by deactivating and reactivating the channel,
- by changing the range.

17. MULTIMETER MODE "THE CHANNEL A OR B MENU"

17.1. THE CHANNEL "A" OR "B" MENU



Press one of these two keys.

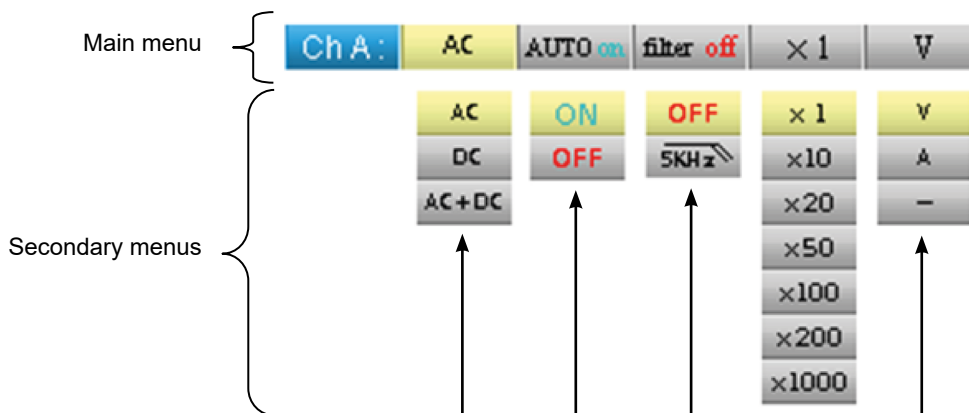

- selects the channel coupling (AC, DC, or AC+DC)
See example
- activates or deactivates autorange
- selects the channel sensor factor (OFF, 5 kHz)
- selects the channel sensor factor (x1 to x1000)
- selects the channel unit (Volt, Amps, -)

17.2. NOTES

(1) These tabs are not accessible if the following types of measurement are validated:

- Capacitance meter
- Ohmmeter
- Component test
- Continuity
- RPM

(2) These tabs are not accessible if the following types of measurement are validated:

- Component test
- Continuity
- RPM

17.3. EXAMPLE : MULTIMETER COUPLING

In voltmeter mode, 3 types of coupling are possible:

- AC is used to measure the VAC RMS voltage of the signal without its DC component,
- DC is used to measure the signal's VDC voltage,
- AC + DC gives the VAC + DC RMS voltage of the entire signal.

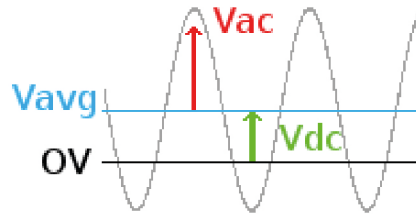

where: $V_{AC+DC} = \sqrt{V_{AC}^2 + V_{DC}^2}$

18. MULTIMETER MODE "THE MEMORY MENU"

18.1. THE "MEMORY" MENU



Press this key.



■ selects saved trace management (.txt)

■ selects save configuration management (.cfg)

■ selects saved screenshot management (.bmp)

- The .bmp file can be recovered on a PC using SX-METRO software/ Oscilloscope mode, import memory.
- The multimeter mode of the Handscope is compatible with SX-DMM software v3.

19. HARMONIC ANALYSER MODE "THE KEYS"



Press this key selects the "Harmonic Analyser" mode.

19.1. "MENU" KEYS

Trigger



inactive in "Harmonic Analyser" mode.

Acquisition



displays the main "Acquisition and Display" menu: access to orders of harmonics, averaging, zoom.

Tools



displays the main "Tools" menu, id. to the Oscilloscope mode.

Measurement



inactive in "Harmonic Analyser" mode.

Memory



displays the main "Memory" menu.

Help



displays the "Help" window, identical to the Oscilloscope mode

19.2. 3 KEYS CHANNEL "A" + "B" AND MATH



A single press selects channel A (or B) and shows the corresponding menu.



Pressing twice deselects the channel.



inactive in "Harmonic Analyser" mode.

19.3. 2 "TIME BASE" KEYS



inactive in "Harmonic Analyser" mode.



inactive in "Harmonic Analyser" mode.

19.4. 2 "SENSITIVITY" KEYS



same as "Oscilloscope " mode.



same as "Oscilloscope " mode.

19.5. 2 FUNCTIONAL KEYS



same as "Oscilloscope" mode.



inactive in "Harmonic Analyser" mode.

20. HARMONIC ANALYSER MODE "DISPLAY"

20.1. DISPLAY

The indication using a double black line on the harmonics corresponds to the representation of overshooting harmonics.

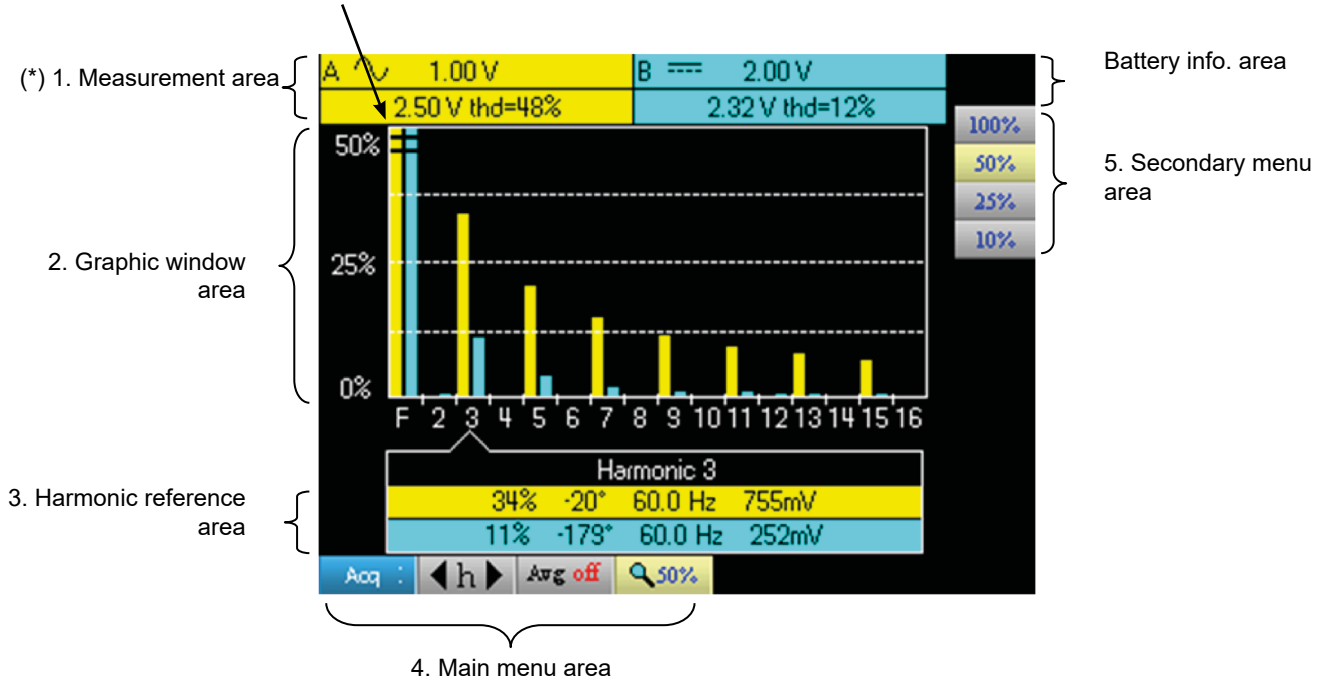

(*) If no measurement is selected, or if the channel is not validated, the measurement will be replaced by dots.

20.2. MEASUREMENT ZONE

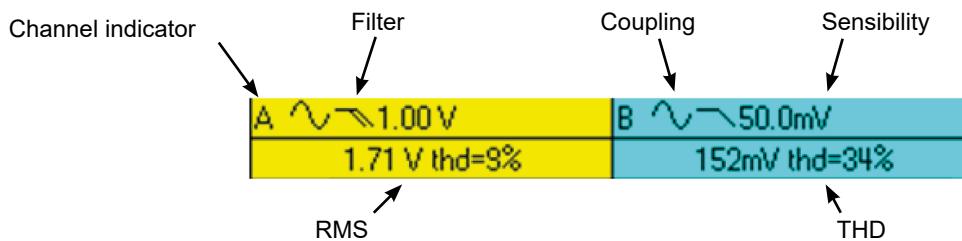

This window displays two measurements and contains data on the channels:

- Channel indicator
- Coupling
- Filter
- RMS voltage of the signal in V
- Total Harmonic Distortion (THD) in %

20.3. HARMONIC DISPLAY AREA

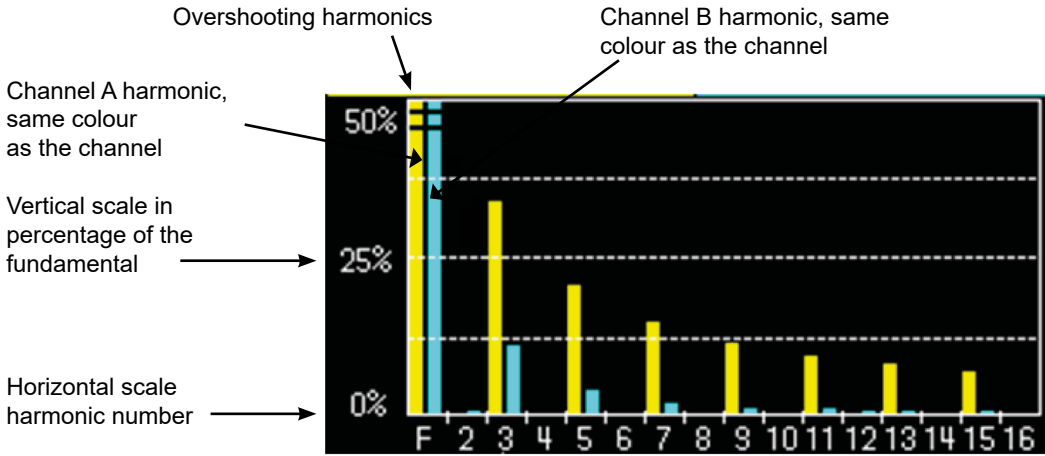

This area displays harmonics 1 to 16 of the validated channels in the form of a bar chart. The user can switch from the display of harmonics 2 to 16 to the display of harmonics 17 to 31. The max. vertical scale will depend on the zoom factor. The zoom factor can be modified using the Acq menu.

20.4. HARMONIC REFERENCE AREA

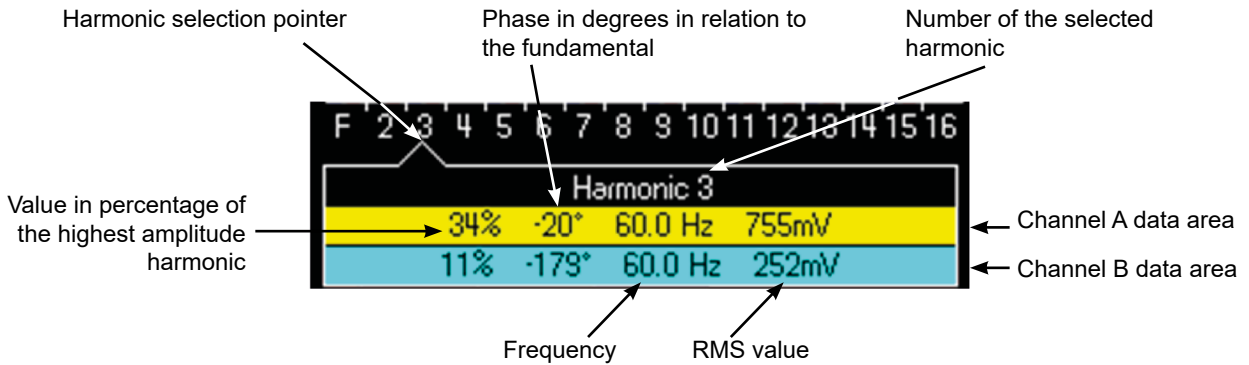

This window displays the specific measurements of the selected harmonic for each channel. The following measurements are displayed:

- the value in % of the highest amplitude harmonic
- the phase in degrees in relation to the fundamental
- the frequency in Hz
- the RMS voltage in V

The title of the group corresponds to the harmonic selected. Grounds of different colours distinguish the measurements of channel A from those of channel B.

20.5. MAIN AND SECONDARY MENU ZONES

The menus automatically disappear and full screen mode is activated/restored after about twenty seconds with no action on the keypad. Pressing the button of the menu displays it again.

21. HARMONIC ANALYSER MODE "THE CHANNEL A OR B MENU"

21.1. THE CHANNEL "A" OR "B" MENU

This menu operates in exactly the same way as in the "Oscilloscope" mode.



Press one of these two keys.

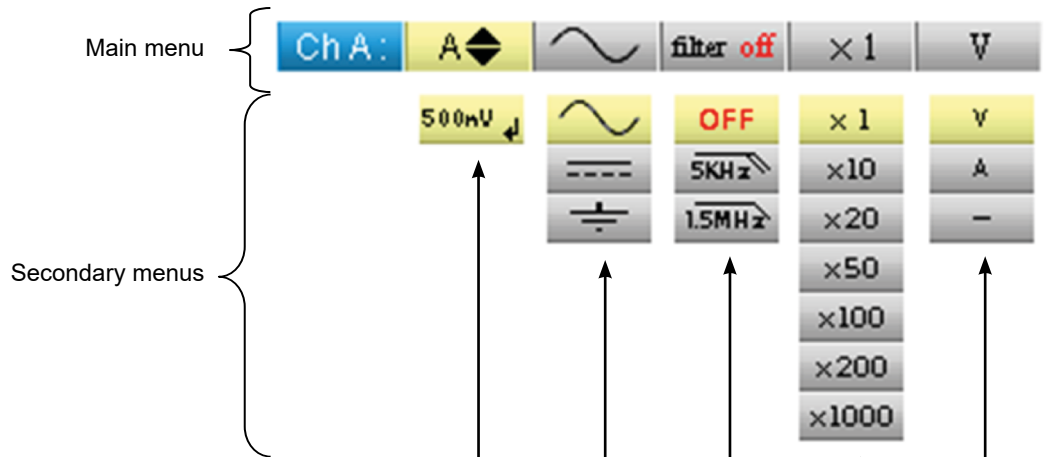

- displays the numeric offset value
- selects the channel coupling (AC, DC, GND)
- selects the channel filter (OFF, 5 kHz, 1.5 MHz)
- selects the channel factor (from x1 to x1000)
- selects the channel unit (Volt, Amps, -)

22. HARMONIC ANALYSER MODE "ACQUISITION MENU"

22.1. THE "ACQUISITION" MENU

Acq

Press this key.

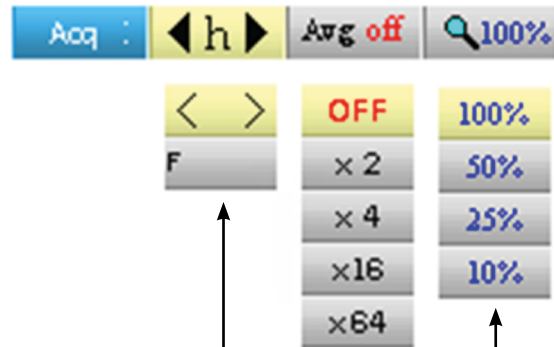

- adjusts and displays the number of the selected harmonic



Exit tab

- Avering
Identical to "Oscilloscope" mode

- selects the vertical zoom factor

100%	100 % of the fundamental
50%	50 % of the fundamental
25%	25 % of the fundamental
10%	10 % of the fundamental

The user can change the vertical scale of the harmonics display area so that it is easier to view the harmonics with low amplitude compared with the fundamental.

23. HARMONIC ANALYSER MODE "MEMORY MENU"

23.1. THE "MEMORY" MENU

This menu operates in exactly the same way as in the "Oscilloscope" mode.



Press this key.



- manages stored configurations (.cfg)

- manages stored screenshots (.bmp)

- The .bmp file can be recovered on a PC using SX-METRO software/ Oscilloscope mode, import memory.

24. REMOTE PROGRAMMING

24.1. PRESENTATION

The oscilloscope can be programmed remotely from a computer:

- either using the SX-METRO software,
- or using basic standardised commands that comply with the IEEE488.2 standard and the SCPI protocol.

This remote programming is used to:

- Configure the instrument
- Perform measurements and retrieve the results
- Transfer files (traces, configuration, screenshots, etc.)

Here we will only describe the connection of the oscilloscope to SX-METRO. For all other use, refer to the remote programming instructions.

24.2. CONNECTING THE OSCILLOSCOPE

The dialogue between the instrument and the PC is carried out via the USB/optical link provided by the HX0056-Z cable.

- Connect the USB end of the cable to one of the PC USB ports (if necessary install the driver shipped with the cable).
- Connect the optical connector to the oscilloscope after first powering it up.
- Open SX-METRO; select USB communications and wait for communications to be established (in the event of a problem, refer to the SX-METRO instructions).

24.3. UPDATING

See § MAINTENANCE section

25. TECHNICAL SPECIFICATIONS "OSCILLOSCOPE MODE"

Only the assigned tolerance or limit values are guaranteed (after 30 minutes to adapt to temperature).
Values without tolerances are given for information purposes only.

25.1. VERTICAL DEFLECTION

Specifications	CA 922	CA 942
Number of channels	2 channels	
Vertical calibres	5 mV to 200 V/div. Variations par bonds (pas de coefficient variable continu)	
BP at -3 dB	20 MHz	40 MHz
	 Measured on a load of 50 Ohms with a 6 div. amplitude signal	
Max input voltage	600 VDC, 600 Vrms Derating : -20 dB per decade from 100 kHz to 40 MHz	
Types of inputs	Safety connector: class 2, insulated inputs	
Dynamics of vertical offset	± 5 div. on all calibres	
Input coupling	AC : 10 Hz to 20 MHz DC : 0 to 20 MHz GND : reference	AC : 10 Hz to 40 MHz DC : 0 to 40 MHz GND : reference
Bandwidth limit	1.5 MHz	5 kHz
Rise time	approx. 17.5 ns	approx. 8.75 ns
Cross-talk between channels	> 60 dB same sensitivity on both channels	
Response to 1 kHz and 1 MHz rectangular signals	Positive or negative overshoot Overshoot ≤ 4 %	
Vertical display resolution	± 0.26 % of the full scale at the best (without measurements, without cursors)	
Accuracy of peak-to-peak gains	± 2 % with averaging of 4 at 1 kHz	
Accuracy of vertical measurements in DC with offset and averaging of 16	± [2.5 % (reading) + 13 % (sensitivity) + 0.5 mV] Applies to the following measurements: Vmin, Vmax, Vlow, Vhigh, Vavg, vertical cursors	
Accuracy of vertical measurements in AC without offset at 1 kHz and averaging of 16	± [2 % (reading) + 2 % (sensitivity)] Applies to the following measurements: Vamp, Veff, Dep+, Dep-	
Sensors	The attenuation factor is to be applied in the channel menu	
Vertical ZOOM function on an acquired or stored curve	none	
Electrical safety without accessories	600 V, CAT III, double insulation	
Max. voltages	floating: 600 V, CAT III from 50 to 400 Hz between channels: 600 V, CAT III from 50 to 400 Hz Frequency derating from 401 Hz to 100 kHz: 300 V MAX	
Input impedance	1 MΩ ± 0.5 % approx. 17 pF	
Measurements on PWM variator	measurements only on installation not exceeding . 400 V three-phase	
Spurious capacitance between the grounds of channels A and B	approx. 340 pF	

25.2. HORIZONTAL DEFLECTION (TIME BASE)

Specifications	CA 922	CA 942
Time base calibres	from 25 ns to 200 s/div. such that : <ul style="list-style-type: none"> ■ Actual time: from 200 s/div. to 5 µs/div. ■ ETS: from 2.5 µs/div. to 125 ns/div. Zoomed ETS: 50 ns/div. and 25 ns/div. For time bases from 200 s/div. to 100 ms/div., the samples are displayed as soon as the trigger is present.	
Accuracy of the time base	± [500 ppm + 0.04 div.] (equ. to ± [0.05 % + 0.04 div.]	
Sampling frequency	50 MSps in real time	
	2 GS/sec. in ETS	
Accuracy of time measurements	± [(0.02 div.) x (time/div.) + 0.01 x reading + 5 ns]	
Horizontal ZOOM	Zoom factor: x 1, x 2 and x 5 In ZOOM mode there is the same time-base calibre sequence as in normal mode. The horizontal screen resolution is 540 points for 10 divisions.	
XY Mode	The bandwidths are identical in X and Y (see §. Vertical offset). As in the standard mode, the sampling frequency depends on the time base value.	
Phase error	< 3°	

25.3. TRIGGER CIRCUIT

Trigger sources	A, B	
Trigger mode	Automatic/Triggered/One shot (roll if the time base ≥ 100 ms/div.)	
Trigger coupling with band limitation	DC (default): 0 to 20 MHz HFreject: 0 to 10 kHz LFreject: 10 kHz to 20 MHz	DC (default): 0 to 40 MHz HFreject: 0 to 10 kHz LFreject: 10 kHz to 40 MHz
Trigger slope	Rising or falling edge	
Trigger sensitivity (without noise rejection)	1.2 div. peak-to-peak from DC to 20 MHz	1.2 div. peak-to-peak from DC to 40 MHz
Noise rejection	± 1.5 div.	
Vertical trigger Variation range	± 8 div.	
Horizontal trigger Variation range	Trig after delay (from -10 div. up to the left of the screen)	
Trigger type	edge	
	pulse width	< t ≈ t > t

25.4. ACQUISITION CHAIN

Specifications	CA 922	CA 942
Resolution of the ADC	9 bits	
Maximum sampling frequency	50 MS/s in real time / 1 converter per channel	
Transient capture MIN/MAX mode	Minimum width for detectable glitches: > 20 ns	
	1250 MIN/MAX couples	
Depth of acquisition memory	2500 pts per channel	

25.5. FORMATS OF THE DIFFERENT FILES

Specifications	CA 922	CA 942
Backup memory	Managed in a file system Total size 2 MB (500 kB of which used by File System) to store various objects: <ul style="list-style-type: none"> ■ traces ■ configurations ■ screenshots 	
Trace files acquired in SCOPE mode Extension : .TRC ex. : trace-xx.TRC	Binary format Size: ≈ 10 ko	
Configuration files Extension : .CFG ex. : setup-xx.CFG	Binary format Size: ≈ 1 ko	
Image files Extension : .BMP ex. : screen-xx.BMP	Binary format Size: .BMP: ≈ 75 ko	
Files containing text Extension : .TXT ex. : trace-xx.TXT ex. : meter-xx.TXT	Text format The .TXT extension files can contain measurements made using the instrument's different acquisition modes.	
	Trace acquired in SCOPE mode Size: ≈ 25 ko.	
	Measurement in Meter mode Size: ≈ 80 ko.	

25.6. MEASUREMENT PROCESSING

25.6.1. MATHEMATICAL FUNCTIONS

Choice from:

- opposite
- addition
- subtraction
- multiplication
- division

The display is adjusted using a factor: / 5, / 2, x 1, x 2, x 5.

25.6.2. AUTOMATIC MEASUREMENTS

Time measurements

- rise time
- fall time
- positive pulse
- negative pulse
- duty cycle
- period
- frequency
- phase (A % B)
- meter

Level measurements

- DC voltage
- RMS voltage
- peak-to-peak voltage
- amplitude
- max. voltage
- min. voltage
- upper plateau
- lower plateau
- overshoot

Measurement resolution : Display on 4 digits

25.6.3. CURSOR

- Accuracy of vertical measurements $\pm [2.5 \% (\text{reading}) + 13 \% (\text{sensitivity}) + 0.5 \text{ mV}]$
- Accuracy of time measurements $\pm [0.02 \times (t/\text{div.}) + 0.01 \% (\text{reading}) + 5 \text{ ns}]$
- Operation The cursors are attached to the curve.

25.7. DISPLAY

Specifications	CA 922	CA 942
Display screen	LCD 3.5" TFT (color display) Backlit LED	
Resolution	1/4 VGA, i.e. 320 horizontal pixels x 240 vertical pixels	
Window viewed in normal mode	Complete memory: 2500 540 pts from the 2500 in the complete memory	
Display modes	<p>Entire acquisition Display of all the samples acquired in a burst with linear interpolation between 2 acquired points (default mode)</p> <p>Min/Max Display of min and max on each X axis acquired in a burst.</p> <p>Enveloppe Display of min and max on each X axis acquired in several bursts.</p> <p>Moyennage Factors from: none, 2, 4, 16, 64</p>	
Reticle	Complete and borders	
Screen indication	<p>Triggering Position of the triggering level (with coupling and overshoot indicator) Position of the Trigger point on the zoom indicator and the upper edge of the screen (with overshoot indicators)</p> <p>Traces Trace identifiers, trace activation: position, sensitivity, earth reference, high and low overshoot indicators if traces outside screen</p>	

25.7.1. OTHER

1/10th Sensor calibration signals	Form: rectangular Amplitude: 0 - 3 V Frequency: \approx 1 kHz  Connect the sensor cold point to the cold point of the sensor calibration output								
Autotest	<table> <tr> <td>Search time</td> <td>< 5 s</td> </tr> <tr> <td>Frequency range</td> <td>> 10 Hz</td> </tr> <tr> <td>Amplitude range</td> <td>10 mVpp to 400 Vpp</td> </tr> <tr> <td>Duty cycle limits</td> <td>from 20 to 80 %</td> </tr> </table>	Search time	< 5 s	Frequency range	> 10 Hz	Amplitude range	10 mVpp to 400 Vpp	Duty cycle limits	from 20 to 80 %
Search time	< 5 s								
Frequency range	> 10 Hz								
Amplitude range	10 mVpp to 400 Vpp								
Duty cycle limits	from 20 to 80 %								

26. TECHNICAL SPECIFICATIONS "ACCESSORIES"

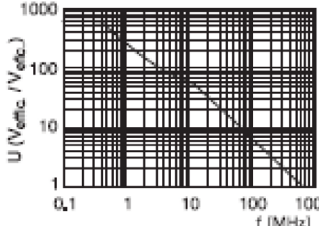
<p style="text-align: center;">1/10 Sensor</p> 	<p>Measurement category Bandwidth Input capacitance Compensation range Rise time Input impedance DERATING Accessories</p>	<p>600 V CAT III DC to 500 MHz 12 pF 12 pF to 25 pF 0.9 ns 10 MΩ see opposite wire holder and earth crocodile clip</p>
<p style="text-align: center;">BNC Banana adapter</p>	<p>Measurement category Diameter</p>	<p>600 V CAT III 4 mm</p>
<p style="text-align: center;">Measurement cable</p>	<p>Measurement category Diameter Termination</p>	<p>600 V CAT III 4 mm test probe</p>
<p style="text-align: center;">Current clamp</p>	<p>Measurement category Connection</p>	<p>600 V CAT III BNC</p>
<p style="text-align: center;">Active thermocouple adapter</p>	Adapter for K thermocouple	
	<p>Measurement range Transformation ratio Choice of unit Accuracy Accuracy LED Particularity Connection Operating range Battery</p>	<p>-40 °C to 1000 °C -40 °K to 1800 °K 1 mV / °C 1 mV / °K °C or °K [-40° C → 0° C] ± (0.8 % ± 2 mV) [0° C → 400° C] ± (0.5 % ± 1 mV) low battery differential measurement banana 0 to 50 °C, < 40 % HR 9 V</p>
<p style="text-align: center;">Infrared temperature sensor</p>	<p>Measurement range Transformation ratio Accuracy Distance Connection Operating range Battery</p>	<p>- 30 to 550 °C 1 mV / °C ± (2 % ± 2°C) between 5 cm and 30 cm banana 0 to 50 °C, < 80 % HR 9 V</p>
<p style="text-align: center;">Tachometer</p>	<p>Measurement range Signal Accuracy Distance Connection Operating range Battery</p>	<p>6 to 120 000 RPM pulse ± 0.5 % between 5 cm and 30 cm banana 0 to 50 °C, < 80 % HR 9 V</p>

27. TECHNICAL SPECIFICATIONS "MULTIMETER MODE"

Only the assigned tolerance or limit values are guaranteed (after 30 minutes to adapt to temperature). Values without tolerances are given for information purposes only.

Display	8000 points for voltmeter			
Entry impedance	1 M Ω			
Max input voltage	600 Vrms sine and 600 VDC, without sensor			
Max floating voltage	600 Vrms up to 400 Hz CAT III			
DC measurement				
Ranges	0.8 V	8 V	80 V	800 V
Resolution	0.1 mV	1 mV	10 mV	0.1 V
Accuracy	$\pm (1 \% + 20 D)$ in DC from 10 % to 100 % of scale			
Common mode rejection	> 60 dB to 50 or 60 Hz			
AC and AC+DC measurements				
Ranges	0.6 V 0.8 V	6 V 8 V	60 V 80 V	600 Vrms sine 800 Vpeak
Resolution	0.1 mV	1 mV	10 mV	0.1 V
Coupling accuracy AC+DC	$\pm (1 \% + 20 D)$ from DC to 5 kHz of 10 % to 100 % of scale \rightarrow 580 Vrms $\pm (2 \% + 20 D)$ from 5 to 10 kHz id. $\pm (3 \% + 20 D)$ from 10 to 50 kHz id. $\pm (1 \% + 20 D)$ from 40 Hz to 5 kHz id.			
AC	$\pm (2 \% + 20 D)$ from 5 to 10 kHz id. $\pm (3 \% + 20 D)$ from 10 to 50 kHz id.			
Common mode rejection	> 60 dB to 50 or 60 Hz			
Resistance measurement	On channel 1			
Ranges (end of scale)	Ohmmeter	Resolution	Measurement current	
	80 Ω	0.01 Ω	0.05 mA	
	800 Ω	0.1 Ω	0.5 mA	
	8 k Ω	1 Ω	5 μ A	
	80 k Ω	10 Ω	5 μ A	
	800 k Ω	100 Ω	500 nA	
	8 M Ω	1000 Ω	50 nA	
	32 M Ω	10 k Ω	50 nA	
Accuracy	$\pm (2 \% + 10 D + 0.2 \Omega)$ from 10 % to 100 % of scale			
Voltage in open circuit	≈ 3 V			
Continuity measurement	On channel 1			
Beeper	< 30 $\Omega \pm 5 \Omega$			
Measurement current	≈ 0.5 mA			
Beeper response	< 10 ms			
Diode test	On channel 1			
Voltage	in open circuit: $\approx + 3,3$ V			
Accuracy	$\pm (1 \% + 10 D)$			
Measurement current	≈ 0.6 mA			

Capacitance measurement	On channel 1			
	Ranges	Capacitance meter	Resolution	Measurement current
		5 mF	1 μ F	500 μ A
		500 μ F	0.1 μ F	500 μ A
	50 μ F	0.01 μ F	500 μ A	
	5 μ F	1 nF	500 μ A	
	500 nF	100 pF	50 μ A	
	50 nF	10 pF	2 μ A	
	5 nF	1 pF	2 μ A	
Accuracy	$\pm (2 \% + 10 D + 200 \text{ pF})$ from 10 % to 100 % of scale			
Cancellation of serial and parallel R	Parallel R > 10 k Ω Use the shortest possible cables.			
Frequency measurement	20 Hz to 50 kHz on sine and square signals 20 Hz to 20 kHz on a triangle signal Accuracy: 0.3 %			
RPM measurement	from 240 to 120,000 RPM Pulse measurement: > 10 μ s exceeding 1.5 V with a hysteresis of 1 V. One pulse corresponds to one rotation.			
PWM measurement with PWM filter + E27 clamp	300 V CAT III Refer to the operating instructions of the filter.			

Operating modes		
Relative mode	Display in relation to a REF base measurement	The Relative, Monitoring and Frequency modes are exclusive.
Monitoring (statistic)	On all measurement values MAX MIN AVG	
Frequency	Possible display of the frequency in AC mode	
Measurement history	Display of the measurement = f (time) 5' (default), 15', 30', 1hr, 6hrs, 12hrs, 24hrs, day, month	
RUN	Start measurements	
HOLD	Freeze the measurement	

Display		
In numeric form	- of the main measurement \rightarrow large scale display - of the secondary measurement \rightarrow small scale display	The secondary measurement can be selected from the menu.
Graphic trace	History of measurements over time Presentation of the measurements in the form of an amplitude bar chart	
Number of measurements represented on the trace	2700	

28. NETWORK "HARMONIC ANALYSIS MODE "

Display of harmonics	All of harmonics	from 2 to 16 + Fundamental from 17 to 31 + Fundamental
Fundamental frequency of the signal analysed		from 40 to 50 Hz
Measurement accuracy	Fundamental level	$\pm (2.5 \% + 15 D)$
	Level of harmonics	$\pm (3.5 \% + 15 D)$
	Harmonic distortion (THD)	$\pm 4 \%$ (calculated on the first 40 harmonics)

29. COMMUNICATION INTERFACES

29.1. USB/OPTICAL INTERFACE

The oscilloscope can communicate with a computer via a USB link using the HX0056-Z adapter cable.

29.1.1. SPECIFICATIONS OF THE OPTICAL LINK

Bauds speed selection: 57600
Parity selection: none
Word lenght selection: 8 bits
Selection of the nr. of stop bits: 1 stop bit
Selection of the protocol: none (no protocol)

30. GENERAL SPECIFICATIONS

30.1. ENVIRONMENT

- Reference temperature 18 °C to 28 °C
- Operating temperature 0 °C to 40 °C
- Storage temperature -20 °C to +60 °C
- Indoor use
- Altitude < 2000 m
- Relative humidity < 80 % up to 35 °C

30.2. POWER SUPPLY

- **Rechargeable battery** 6 x 1.2 V - LR6 or AA
 - Typ NiMH
 - Charge time approx. 3h30
 - Min. battery life approx. 5h45
 - Max. battery life approx. 8h30
(1 channel deactivated, AC coupling)
- **USB external power supply** Battery charger
 - Network voltage 98 V to 264 V
 - Frequency from 50 to 60 Hz
 - Consumption < 11 VA in operation
≅ 19 VA en charge rapide batterie
 - Voltage 5 VDC
2 A
- Polarity 

30.3.

- **Safety** Compliant with IEC/EN 61010-1 or BS EN 61010-1 and IEC/EN 61010-2-030 or BS EN 61010-2-030:
 - Insulation class 2
 - Pollution degree 2
 - Overvoltage category
for "measurement" inputs: 600 V CAT III
- **EMC**

This instrument complies with the IEC/EN 61326-1 or BS EN 61326-1 standard.
It has been tested for industrial environments (class A).
In other environments and under special conditions compatibility may be difficult to ensure.

 - Emission Class A
 - Immunity Influence: 0.5 div. in the presence of an electromagnetic field of 10 V/m

Attention: This instrument is not intended for use in residential environments and cannot ensure adequate protection of radio reception in this type of environment.

Note: for use with the external power supply, the jack to USB cord (with a ferrite) must be used.

31. MECHANICAL SPECIFICATIONS

31.1. BOX

- Dimension 214 x 110 x 57 mm
- Oscilloscope weight 0.960 kg with battery
- Power supply weight 0.160 kg

31.2. PACKAGING

- Dimensions 25 x 16.5 x 14.5 cm

32. SUPPLY

32.1. ACCESSORIES

32.1.1. SHIPPED WITH THE AMPLIANCE

- Operating and Programming Manual on CD-ROM - in 5 languages
- External USB power supply + USB to jack cable
- 6 NiMH 1.2 V rechargeable batteries - typ LR6 or AA
- HX0105 bag
- 1/10 600 V CAT III sensor
- BNC adapter to Ø 4 mm connectors
- Ø 4 mm « banana/banana » connectors red black
- Test probe red black
- Alligator clamp red black
- Serial-USB optical cable + Driver

32.1.2. DELIVERED AS OPTIONS

Accessories

- 600 V isolated measuring set, with 1/10 probe 600 V CAT III and BNC adapter to Ø 4 mm bananas
- 20 AAC/DC current clamp, 600 V CAT II, 100 mV/A
- Infrared temperature sensor (1 mV/° C) CA 1871
- Active thermocouple adapter (1 mV/° C or 1 mV/° K) CA 801
- Active differential thermocouple adapter (1 mV/° C or 1 mV/° K) CA 803
- Tachometer CA 1711
- BNC M/BAN F4 600 V adapters (x 2)
- PWM Kit

Other

- Generator circuit for oscilloscopes
- SX-METRO application software

33. MAINTENANCE

33.1. CLEANING

- Disconnect the measurement probes or leads.
- Power down the instrument.
- Use a soft cloth moistened with soapy water.
- Rinse with a damp cloth.
- Dry rapidly with a dry cloth or forced air.
- Do not use alcohol or a hydrocarbon or other solvent.

Do not use the instrument again until it is completely dry.

33.2. UPDATING THE INTERNAL SOFTWARE OF THE INSTRUMENT

- Log in to the site <http://www.chauvin-arnoux.com>
- Under the "Support" heading, select "Download Space"
- Download the Firmware corresponding to the model of your instrument using the embedded Metrix "LoaderScope" oscilloscope software
- Also download the operating instructions of this Firmware
- Refer to these operating instructions when updating your instrument.

34. WARRANTY

This equipment is guaranteed for three years against defects of materials or workmanship, under the general terms of sale.

During this period, the instrument can be repaired only by the manufacturer, which reserves the right to repair or replace the whole instrument or part thereof. If the equipment is sent back to the manufacturer, carriage is paid by the customer.

The warranty is void following:

- improper use of the equipment or use in association with incompatible equipment,
- any modification of the equipment without express authorization by the manufacturer's technical staff,
- work on the equipment done by a person not approved by the manufacturer,
- adaptation to a particular application not anticipated in the specifications of the equipment or in the operating instructions,
- a shock, a fall, or flooding.

35. REMOTE PROGRAMMING MANUAL

35.1. PRESENTATION

The oscilloscope can be remotely programmed with a computer, from simple standardized commands and using the optical interface USB-RS.

The programming instructions comply with standard IEEE488.2, and the SCPI protocol (Standard Commands for Programmable Instruments).

This remote programming enables :

- Instrument configuration
- Measurement campaigns and their repatriation
- File transfer (traces, configuration, hardcopy ...)

35.2. CONNECTION OF THE INSTRUMENT

The dialogue between the instrument and the PC can be realized via the optical USB link through the HX0056-Z cable.

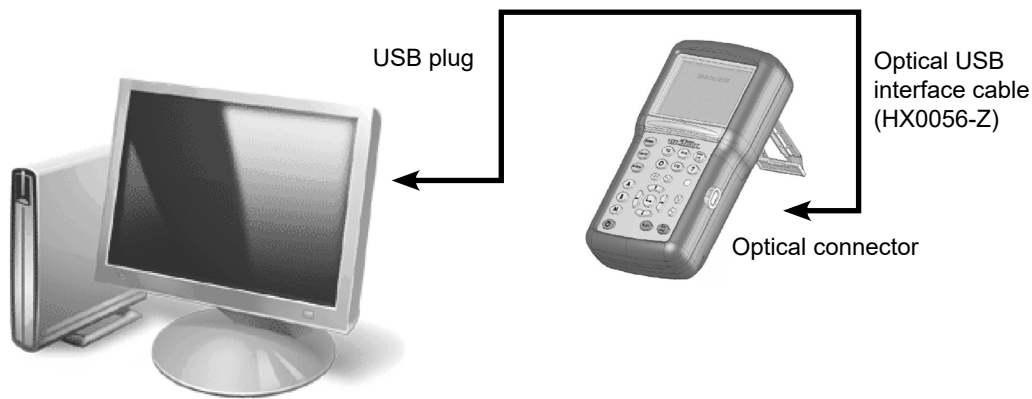

- Connect the USB side of the cable to one of the PC USB inputs.
- If necessary, install the USB driver supplied with the cord.
- The PC's operating system creates a virtual communication port COM*i* (with '*i*' number depending on your computer).
- Configure the PC port created on the PC to the same parameters as those of the oscilloscope.

35.2.1. OPTICAL LINK SPECIFICATIONS

- Speed 57600 bauds
- Format 8 bits
- Stopbit 1 bit
- Parity none
- Flow control none

35.3. PROGRAMMING CONVENTION

35.3.1. TREE STRUCTURE

- The Command SCPI structure is a tree structure
- Each command must be ended by a <NL> or <:> terminator character.
- The command used after the <:> character must be in the same directory as the precedent command, otherwise it must be preceded by the <:> character and its full name.

Example :

```
DISP:TRAC:STAT1 1<NL>
DISP:TRAC:STAT2 1<NL>
same as :
DISP:TRAC:STAT1 1;STAT2 1<NL>
same as :
DISP:TRAC:STAT1 1;; DISP:TRAC:STAT2 1<NL>
```

35.4. COMMAND SYNTAX

35.4.1. COMMON COMMANDS

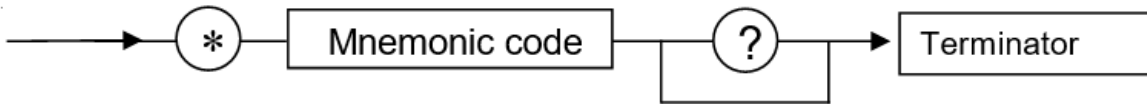

35.4.2. SPECIFIC COMMANDS

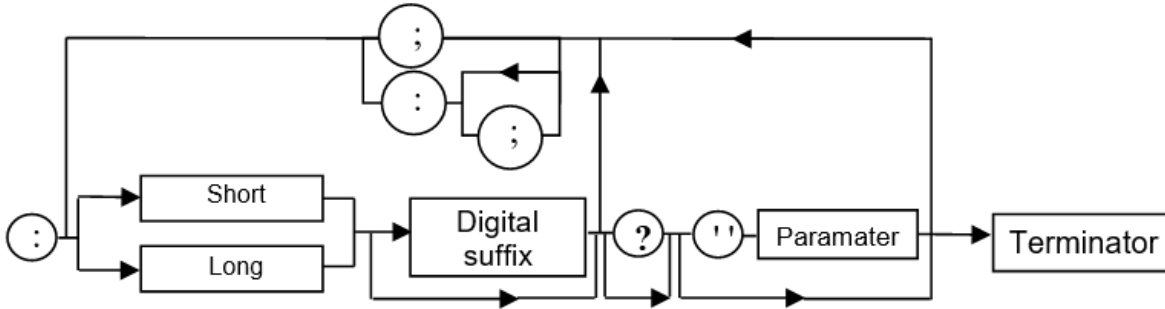

35.4.3. KEY WORDS

The brackets ([]) are used to frame a keyword which is optional during programming; i.e. the instrument will execute the command whether the keyword is optional or not. Uppercase and lowercase are used to differentiate the short form of the keyword (uppercase letters) and the long form (whole word).

The instrument accepts the uppercase or lowercase letters without distinction.

DISP:TRAC:STAT 1 is equivalent to DISPLAY:WINDOW:TRACE:STATE 1

35.4.4. SEPARATORS

- ' : ' descends in the next directory or returns under the root, if preceded by a ' ; '.
- ' ; ' separates two commands in the same directory
- ' ' (space) separates the keyword from the following parameter.
- ' ; ' separates a parameter from the following

35.4.5. PARAMETERS

- < > The defined-types are marked by the opposite characters.
- [] The brackets ([]) mean that the parameters are optional.
- { } The accolades define the list of parameters allowed.
- | The vertical bar (|) may be read as an "or", it separates the various possible parameters.

35.4.6. PARAMETER FORMAT

The parameters can be key words, numeric values, character chains or numeric expressions. The interpreter does not make any difference between capital and small letters.

Key words:

These parameters have two forms of call, as for the instructions : the shortened form (in capital letter) and the whole form (shortened form plus complement into small letter).

Thus, for certain commands, the parameters are the following :

- ON, OFF corresponding to the boolean values (1,0)
- EDGE, PULse for the trigger modes

Numeric values:

There are several values :

NRF (flexible Numeric Representation).

In the case of physical quantity, these numbers can be or not by a multiple and its unit.

Reminder:

The interpreter does not make any difference between capital and small letters.

Example : to enter a duration of 1 micro second, it can be written either: 1us, or 0.000001, or 1e-6s, or 1E-3ms ...

This parameter can also be replaced by the following key words :

- MAXimum, MINimum to get extreme values of the parameter
- UP, DOWN to get the value following or preceding the current status of the parameter

Units:	V	Volt (Voltage)
	S	Second (Time)
	PCT	Percent (Percentage)
	Hz	Hertz (Frequency)
	MHz	Mega-Hertz (Frequency)
	F	Farad (Capacitance)
	OHM	Ohm (Resistance)
	DEG	Degree Celsius
	RPM	Rotation per minute

Multiples and sub-multiples:

MA	Mega: 10^{+6}
K	Kilo: 10^{+3}
M	Mili: 10^{-3}
U	Micro: 10^{-6}
N	Nano: 10^{-9}
P	Pico: 10^{-12}

NR1 The parameter is a signed whole number

Example : 10

NR2 The parameter is a signed real without exponent.

Example : 10.1

NR3 The parameter is a signed real expressed with a mantisse and a signed exponent.

Example : 10.1e-3

Chains of Characters: They are continuations of letters and figures framed by quotation marks " " .

Terminator : <NL> is a general term for a terminator.

NL is the character CR (codeASCII 13 or 0x0D).

A line of command should not exceed 80 characters; if ends with a terminator.

35.5. RESPONSE SYNTAX

The response can be made up of several elements separated between them by a comma ', ' . The last element is followed by the terminator < NL > .

There are several data :

Key words:

They are the same ones as those used in parameter, but here, only the shortened form is returned.

Numeric Values:

They have three possible formats : NR1, NR2 et NR3.

Chains of Characters:

There is no difference compared to the parameters. If the chain contains a key word, it is returned in shortened form.

36. COMMANDS SPECIFIC TO THE INSTRUMENT "OSCILLOSCOPE MODE"

36.1. VERTICAL

36.1.1. DISPLAY

DISPlay[:WINDow]
:TRACe:STATe{[1]|2|3}

(Command/Query)

The **DISP:TRAC:STAT{[1]|2|3} <1|0|ON|OFF>** command validates or devalidates the selected signal. To the question **DISP:TRAC:STAT{[1]|2|3}?**, the instrument returns the validation status of the selected signal.

Channel 3 corresponds to the MATH function.

36.1.2. SENSITIVITY / COUPLING

[SENSe]:VOLTage
{[1]|2}[:DC]:RANGe
:PTPeak

(Command)

VOLT{[1]|2}:RANG:PTP <sensitivity|MAX|MIN|UP|DOWN>
sets the full screen vertical sensitivity of the selected channel.

<sensitivity> is a value in **NRf** format, it may be followed or not by a multiple and the unit.

By default the value is expressed in volt.

To the question **VOLT{[1]|2}:RANG:PTP?**, the instrument returns the full screen vertical sensitivity of the selected channel.

Response format: <measured value><NL>
value in format **<NR3>** expressed in volt.

If 10mV/div is the sensitivity displayed in the channel parameters, then the **<sensitivity>** parameter = 8 x 10 mV/div.

Channel 3 corresponds to the math function for which the sensitivity is accessible in reading only.

[SENSe]:VOLTage
{[1]|2|3}[:DC]
:RANGe:OFFSet

(Command/Query)

The **VOLT{[1]|2|3}:RANG:OFFS <offset|MAX|MIN|UP|DOWN>** command sets the vertical offset of the time representation of the selected signal.

<offset> is a value in **NRf** format, it may be followed or not by a multiple and the unit.

By default the value is expressed in volt.

To the question **V{[1]|2|3}:RANG:OFFS?**, the instrument returns the vertical offset of the selected signal.

Response format: <measured value><NL>
value in format **<NR3>** expressed in volt.

INPut{[1]|2}:COUPLing

(Command/Query)

The **INP{[1]|2}:COUP <AC|DC|GROund>** command selects the coupling of the selected channel.

To the question **INP{[1]|2}:COUP?**, the instrument returns the coupling of the selected channel.

[SENSe]:BANDwidth
{[1]|2}[:RESolution]

(Command/Query)

The **BAND{[1]|2} <Bandwidth>** command limits the channel bandwidth to the value of the parameter [5 kHz ; 1,5 MHz ; 20 MHz ; 0 (no bandwidth limit)].

To the question **BAND{[1]|2}?**, the instrument returns the value of the filter cut-off frequency [5 kHz ; 1,5 MHz ; 20 MHz ; 0 (no bandwidth limit)].

[SENSe]:BANDwidth
{[1]|2}[:RESolution]
:AUTO

(Command/Query)

The command **BAND{[1]|2}:AUTO <1|0|ON|OFF>** validates the 1.5 MHz bandwidth or devalidates the application of the bandwidth limit on the selected channel.

To the question **BAND{[1]|2}:AUTO?**, the instrument returns the activation status of the bandwidth limit on the selected channel.

36.1.3. FUNCTION DEFINITION

CALCulate:MATH

[:EXPRession] [:DEFine] (Command/Query)

The **CALC:MATH <(function)>** command defines and activates the mathematical function.

<function> is the definition of the mathematical function. Possible functions are: (-A), (-B), (A+B), (A-B), (A*B) ou (A/B).

<(multiplier)> is the multiplier to be applied to the function. Possible multipliers are (1), (*2), (*5), (/2) ou (/5).

Note: (A-B),(*2) subtract the channel A to the channel B and multiplies the result by 2 (acc. to following calculation : (A-B)*2).

To the question **CALC:MATH?**, the instrument returns the mathematical function and its multiplier.

Response format: <(function),(multiplier)><NL>

36.1.4. VERTICAL SCALE

DISPlay[:WINDow]

:TRACe:Y[:SCALe]

:PDIVision{[1][2]}

(Command/Query)

The command **DISP:TRAC:Y:PDIV{[1][2]} <scale|MAX|MIN>** sets the value of the probe coefficient for the selected signal.

<scale> is a value at **NRf** format.

To the question **DISP:TRAC:Y:PDIV{[1][2]}?**, the instrument returns the value of the probe coefficient for the selected signal.

DISPlay[:WINDow]

:TRACe:Y:LABel{[1][2]}

(Command/Query)

The **DISP:TRAC:Y:LAB{[1][2]} <"label">** command determines the unit of the selected signal.

The unit is selected among the upper-case letters of the alphabet (A to Z), and is composed of a name up to 3 letters.

To the question **DISP:TRAC:Y:LAB{[1][2]}?**, the instrument returns the unit of the selected signal.

Channel 3 corresponds to the MATH function for which the sensitivity is accessible in reading only.

36.2. TRIGGER

With SCPI he various trigger modes can be accessed with the sequence concept.

The instrument has several trigger modes, thus several sequences:

- Sequence 1 : Trigger on edge (EDGE)
- Sequence 2 : Trigger on pulse width (PULse)

The sequence can be selected with the commands: **INIT:CONT:NAME** or **NIT:NAME**

TRIGger[:SEQuence

{[1][2]}:DEFine?

(Commande/Interrogation)

Retourne la description de la séquence indiquée:

SEQuence1: EDGE

SEQuence2: PULse

36.2.1. TRIGGER MAIN SOURCE

TRIGger[:SEQuence

{[1][2]}:SOURce

(Command/Query)

The **TRIG:SOUR <INTernal{1|2}>** command determines the main trigger source of the instrument.

INTernal{1|2} corresponds to the A and B channel instrument.

To the question **TRIG:SOUR?**, the instrument returns the main trigger source used in.

TRIGger[:SEQuence

{[1][2]}

:FILTer:HPASs[:STATe]

(Command/Query)

The **TRIG:FILT:HPAS <1|0|ON|OFF>** command validates or devalidates the reject of the low frequencies associated to the main trigger source.

- **1|ON:** activates the reject of the low frequencies (LF Reject coupling)
- **0|OFF:** deactivates the reject of the low frequencies; the DC coupling is then activated.

To the question **TRIG:FILT:HPAS?**, the instrument returns the activation status of the low frequencies reject associated to the trigger source.

TRIGger[:SEQuence
{[1]|2}]
:FILTer:LPASs[:STATe]

(Command/Query)
To the question **TRIG:FILT:LPAS?**, the instrument returns the activation status the reject of the high frequencies associated to the trigger source.
■ **1|ON**: activates the high frequencies reject (HF Reject coupling)
■ **0|OFF**: deactivates the high frequencies reject; the DC coupling is then activated.
To the question **TRIG:FILT:LPAS?**, the instrument returns the activation status the reject of the high frequencies associated to the trigger source.

TRIGger[:SEQuence
{[1]|2}]:SLOPe

(Command/Query)
TRIG:SEQ{[1]|2}:SLOP <POSitive|NEGative> determines :
■ in **Sequence2** : determines the polarity of the pulse
→ **POSitive**: positive pulse 
→ **NEGative**: negative pulse
To the question **TRIG:SEQ{[1]|2}:SLOP?**, the instrument returns the polarity trigger front or pulse according to the selected SEQuence.
■ In the other sequences: used to measure the triggering edge of the main source:
→ **POSitive**: rising front
→ **NEGative**: falling front

TRIGger[:SEQuence
{[1]|2}]
:HYSTeresis[:STATe]

(Command/Query)
The **TRIG:HYST <hysteresis>** command sets the amplitude of the hysteresis which rejects the noise associated to the trigger main source.
<hysteresis> is a value at NR1 format taking following values :
■ **0**: no noise reject, hysteresis is about 0.5 div.
■ **3**: activated noise reject, hysteresis is about 3 div.
To the question **TRIG:HYST?**, the instrument returns the amplitude of the hysteresis which rejects the noise associated to the trigger main source.

TRIGger[:SEQuence
{[1]|2}]:LEVeL

(Command/Query)
The **TRIG:LEV <level|MAX|MIN|UP|DOWN>** command sets the trigger level of the main source.
<level> is a value in format **NRf**, it may be followed or not by a multiple and by the unit.
By default, the value is expressed in volt.
To the question **TRIG:LEV?**, the instrument returns the trigger level of the main source in SEQuence1.
Response format: <measured value><NL>value in format **<NR3>** expressed in volt.

TRIGger[:SEQuence
[2]]:TYPe

(Command/Query)
The **TRIG:TYP <INferior|SUPerior>** command determines the trigger type on pulse width :
■ **EQUate** : trigger on pulses of duration equal to that one specified with the **TRIG:SEQ2:DEL** command.
■ **SUPerior** : trigger on pulses of duration superior to that one specified with the **TRIG:SEQ2:DEL** command.
■ **INferior** : trigger on pulses of duration inferior to that one specified with the **TRIG:SEQ2:DEL** command.
To the question **TRIG:TYP?**, the instrument returns the trigger type on pulse width.
Response format: <EQU|SUP|INF ><NL>

TRIGger:SEQuence{[2]}
:DELay

(Command/Query)
The **TRIG:DEL <time|MAX|MIN|UP|DOWN>** command sets the duration of pulse comparison.
<time> is a value in format **<NRf>**, it may be then followed or not by a multiple and by the unit.
By default the value is expressed in second.
To the question **TRIG:DEL?**, the instrument returns the trigger delay of the main source or the T1 pulse time according to the selected sequence.
Response format: <measured value><NL>
value in format **<NR3>** expressed in second.

36.2.2. TRIGGER MODE - AUTOMATIC MODE

TRIGger[:SEQuence]
{[1]|2}

:ATRIGger[:STATe] (Command/Query)

The **TRIG:ATRIG <1|0|ON|OFF>** command validates or devalidates the automatic trigger.

- **ON|1** activates the auto trigger mode
- **OFF|0** activates the trigger mode

To the question **TRIG:ATRIG ?**, the instrument returns the activation of the auto trigger.

36.2.3. SINGLESHOT MODE

INITiate[:IMMediate]:
NAME

(Command)

The **INIT:NAME <{EDGE|PULse }>** command launches a singleshot acquisition in the indicated trigger mode.

36.3. HORIZONTAL

36.3.1. MIN/MAX ACQUISITION

[SENSe]:AVERage:
TYPE

(Command/Query)

The **AVER:TYPE <NORMal|ENVELOpe>** command validates or devalidates the mode of min/max acquisition.

- **NORMal** devalidates the mode of min/max acquisition.
- **ENVELOpe** validates the mode of min/max acquisition.

To the question **AVER:TYPE?**, the instrument returns the activation status of the mode of min/max acquisition.

36.3.2. AVERAGE

[SENSe]:AVERage:
COUNT

(Command/Query)

The **AVER:COUN <acquisition number|MAX|MIN|UP|DOWN>** command determines the number of acquisition bursts necessary to obtain a displayed trace by averaging.

<acquisition number> is a value in format **NR1**, from values **0, 2, 4, 16** to **64**.

To the question **AVER:COUN?**, the instrument returns the number of acquisition bursts necessary to obtain a displayed trace by averaging.

36.3.3. TIME BASE

DISPlay[:WINDow]
:TRACe:X[:SCALe]
:PDIVision

(Command/Query)

The **DISP:TRAC:X:PDIV <scale|MAX|MIN|UP|DOWN >** command sets the value of the time base. **<scale>** is a value in format **NRf**, it may be followed or not by a multiple and by the unit.

By default, the value is expressed in second.

Example: to get a time base of 1 μ s, following values can be entered: **1E-3ms** or **1E-6** or **0.000001s** or **0.000001** or else **1us**

To the question **DISP:TRAC:X:PDIV?**, the instrument returns the value of the time base.

Response format: <measured value><NL>

value in format **<NR3>** expressed in second.

[SENSe]SWEep:OFFSet
:TIME

(Command/Query)

The **SWE:OFFS:TIME <time|MAX|MIN|UP|DOWN>** command sets the horizontal offset of the trace (run-after-delay or posttrig).

<time> is a signed value in format **<NRf>**; it may be followed or not by a multiple and by the unit.

By default, it is expressed in second.

To the question **SWE:OFFS:TIME?**, the instrument returns the current run-after-delay.

Response format: <measured value><NL>

value in format **<NR3>** expressed in second.

36.4. DISPLAY

36.4.1. DISPLAY MODE

DISPlay[:WINDow]:TRACe
:MODE

(Command/Query)

The **DISP:TRAC:MODE <ENVELOPE|ALL>** command selects the sample display mode.

- ENVELOPE : displays in the "Envelope" mode
- ALL : displays in the "All acquisition" mode

To the question **DISP:TRAC:MODE?**, the instrument returns the active display mode.

36.4.2. OSCILLOSCOPE / XY

DISPlay[:WINDow]
:TRACe:FORMat

(Command/Query)

The **DISP:TRAC:FORM <A|XY>** command selects the display mode of the instrument.

- A validates the Oscilloscope display mode : $Y = f(t)$
- XY validates the XY display mode : $Y = f(x)$

To the question **DISP:TRAC:FORM?**, the instrument returns the active display mode.

36.5. MEASURE

36.5.1. REFERENCE

DISPlay[:WINDow]:CURSor
:REFerence

(Command/Query)

The **DISP:CURS:REF <INT{1|2|3}>** command selects the reference for the automatic and manual measurements.

To the question **DISP:CURS:REF?**, the instrument returns the signal used as reference.

36.5.2. MEASUREMENT QUERY

MEASure:MINimum?

(Query)

To the question **MEAS:MIN? <INT{1|2|3}>** the instrument returns the value minimum of the selected signal.

Response format: <measured value><NL>
value in format <NR3> expressed in volt.

MEASure:MAXimum?

(Query)

To the question **MEAS:MAX? <INT{1|2|3}>** the instrument returns the maximum value of the selected signal.

Response format: <measured value><NL>
value in format <NR3> expressed in volt.

MEASure:PTPeak?

(Query)

To the question **MEAS:PTP? <INT{1|2|3}>** the instrument returns the peak-to-peak value of the selected signal.

Response format: <measured value><NL>
value in format <NR3> expressed in volt.

MEASure:LOW? (Query)

To the question **MEAS:LOW? <INT{1|2|3}>** the instrument returns the low level value of the selected signal.

Response format: <measured value><NL>
value in format <NR3> expressed in volt.

MEASure:HIGh? (Query)

To the question **MEAS:HIGh? <INT{1|2|3}>** the instrument returns the value of the high level level of the selected signal.

Response format: <measured value><NL>
value in format <NR3> expressed in volt.

MEASure:AMPLitude? (Query)
 To the question **MEAS:AMPLitude? <INT{1|2|3}>** the instrument returns the amplitude of the selected signal.
Response format: <measured value><NL>
 value in format <NR3> expressed in volt.

MEASure:AC? (Query)
 To the question **MEAS:AC? <INT{1|2|3}>** the instrument returns the RMS voltage of the selected signal.
Response format: <measured value><NL>
 value in format <NR3> expressed in volt.

MEASure:VOLT[:DC]? (Query)
 To the question **MEAS:VOLT? <INT{1|2|3}>** the instrument returns the average value of the selected signal.
Response format: <measured value><NL>
 value in format <NR3> expressed in volt.

MEASure:RISE:OVERshoot? (Query)
 To the question **MEAS:RISE:OVER? <INT{1|2|3}>** the instrument returns the positive overshoot of the selected signal.
Response format: <measured value><NL>
 value in format <NR2> expressed in percent.

MEASure:FALL:OVERshoot? (Query)
 To the question **MEAS:FALL:OVER? <INT{1|2|3}>** the instrument returns the negative overshoot of the selected signal.
Response format: <measured value><NL>
 value in format <NR2> expressed in percent.

MEASure:RISE:TIME?
 or
 MEASure:RTIME? (Query)
 To the question **MEAS:RISE:TIME? <INT{1|2|3}>** the instrument returns the rise time of the selected signal.
Response format: <measured value><NL>
 value in format <NR3> expressed in second.

MEASure:FALL:TIME?
 or
 MEASure:FTIME? (Query)
 To the question **MEAS:FALL:TIME? <INT{1|2|3}>** the instrument returns the fall time of the selected signal.
Response format: <measured value><NL>
 value in format <NR3> expressed in second.

MEASure:PWIDth? (Query)
 To the question **MEAS:PWID? <INT{1|2|3}>** the instrument returns the positive pulse width of the selected signal.
Response format: <measured value><NL>
 value in format <NR3> expressed in second.

MEASure:NWIDth? (Query)
 To the question **MEAS:NWID? <INT{1|2|3}>** the instrument returns the negative pulse width of the selected signal.
Response format: <measured value><NL>
 value in format <NR3> expressed in second.

MEASure:PERiod? (Query)
To the question **MEAS:PERiod? <INT{1|2|3}>** the instrument returns the period of the selected signal.
Response format: <measured value><NL>
value in format <NR3> expressed in second.

MEASure:FREQuency? (Query)
To the question **MEAS:FREQ? <INT{1|2|3}>** the instrument returns the frequency of the selected signal.
Response format: <measured value><NL>
value in format <NR3> expressed in hertz.

MEASure:PDUTYcycle? (Query)
To the question **MEAS:PDUT? <INT{1|2|3}>** the instrument returns the duty cycle of the selected signal.
Response format: <measured value><NL>
value in format <NR2> expressed in percent.

MEASure:PULse:COUNT? (Query)
To the question **MEAS:PUL:COUNT? <INT{1|2|3}>** the instrument returns the pulse count on screen of the selected signal.
Response format: <measured value><NL>
value in format <NR2>.

36.5.3. MEASUREMENT DISPLAY

MEASure{[1]|2|3}:SELECT (Command/Query)
The command **MEAS{[1]|2|3}:SELECT <measure1>,<measure2>** selects automatic measurements for display. <measure1> or <measure2> can take values **NO, MIN, MAX, PTPeak, LOW, HIGH, AMPLitude, ROVERshoot, FOVERshoot, RTIME, FTIME, PWIDTH, FWIDth, FREQuency, PERiod, PDUTYcycle, COUNT, RMS, AVG** or **PHASE**.
To the question **MEAS{[1]|2|3}:SELECT ?** the instrument returns the current automatic measurements selected for display.
Response format: <measure1>,<measure2><NL>

MEASure:AUTO (Command/Query)
The command **MEAS:AUTO <1|0|ON|OFF>** activates the display of the selected automatic measurements.
To the question **MEAS:AUTO?** the instrument returns the display activation state of the automatic measurements.

36.5.4. PHASE MEASUREMENT

MEASure:PHASe? (Query)
To the question **MEAS:PHAS? <INT{1|2}>** the instrument returns the phase of the first selected signal to the second.
Response format: <measured value><NL>
value in format <NR2> expressed in degree.

36.5.5. MANUAL MEASUREMENT

DISPlay[:WINDow]:CURSor:STATe (Command/Query)
The **DISP:CURS:STAT <1|0|ON|OFF>** command activates or inhibits the manual measurements.
■ **1|ON:** activates the manual measurements
■ **0|OFF:** inhibits the manual measurements
To the question **DISP:CURS:STAT?**, the instrument returns the activation status of the manual measurements.

DISPlay[:WINDow]:CURSor

:TIME{[1]|2}:POSition (Command/Query)

The **DISP:CURS:TIME{[1]|2}:POS <position|MAX|MIN>** command sets the horizontal position of the selected manual cursor.

This command acts on the manual cursors represented on the screen by the X-Symboles (cursor 1) and * (cursor 2). The indexes {[1]|2} associated to the TIME key word select the same cursors.

<position> is a value in format **NRf**, it may be followed or not by a multiple and the unit.

By default the value is expressed in second.

To the question **DISP:CURS:TIME{[1]|2}:POS?**, the instrument returns the horizontal position of the selected manual cursor.

Response format: <measured value><NL>

value in format **<NR3>** expressed in second.

DISPlay[:WINDow]:CURSor

:VOLT{[1]|2}:POSition (Query)

To the question **DISP:CURS:VOLT{[1]|2}:POS?**, the instrument returns the horizontal position of the selected manual cursor.

This command acts on the manual cursors represented on the screen by the X-Symboles (cursor 1) and * (cursor 2). The indexes {[1]|2} associated to the TIME key word select the same cursors.

Response format: <measured value><NL>

value in format **<NR3>** expressed in volt.

MEASure:CURSor:DTIME? (Query)

To the question **MEAS:CURS:DTIME?**, the instrument returns the time delay between cursors 1 and 2.

Response format: <measured value><NL>

value in format **<NR3>** expressed in second.

MEASure:CURSor:DVOLT? (Query)

To the question **MEAS:CURS:DVOLT?**, the instrument returns the difference between cursors 1 and 2.

Response format: <measured value><NL>

value in format **<NR3>** expressed in volt.

36.6. MEMORY

36.6.1. TRACE

MMEMory:STORe:TRACe (Command)

The **MMEM:STOR:TRAC <INT{1|2|3}|REF{1|2|3}>, <"TRC"|"TXT">** command generates a **“.TRC”** or **“.TXT”** file from the signal or the indicated reference memory, in the selected file system.

To the question **MMEM:STOR:TRAC?** The instrument returns the file name which has been created.

Response format: <file name><NL>

MMEMory:LOAD:TRACe (Command)

The **MMEM:LOAD:TRAC <" trace-xx.TRC">** command reads a trace defined in a **“.TRC”** file and affects it to the indicated signal.

trace-xx.TRC : file name at xx takes values from 00 to 99.

TRACe:CATalog

(Query)

To the question **TRAC:CAT?**, the device returns the list of active signals.

TRAC:CAT?

reply <NL> when no signal is active.

reply INT1 <NL> when only signal 1 is active.

reply INT1,INT3<NL> when signals 1 and 3 are active.

TRACe:LIMit

(Command/Query)

The **TRAC:LIM** <abscissa1>,<abscissa2>,<step> command sets the left and right limits and the step of the data to be transferred.

<abscissa1>,<abscissa2>,<step> are parameters using format **NR1**.

Their default value is 0, 2499 and 1.

To the question **TRAC:LIM?**, the device returns the left and right limits and the step of the data to be transferred.

TRACe[:DATA]

(Query)

To the question **TRAC? <INT{1|2|3|4}>**, the device transfers the selected trace to the computer.

Response format: <block><NL>

<block> is a data block, the format of which is set by the **FORMat:DINTerchange** and **FORMat[:DATA]** commands.

It contains the value of the 2500 samples encoded on 4 bytes, as follows (bit 31 = MSB):

31	24	19	0
Validity	-	samples coded on 20 bits	

The validity byte contains 3 data bits:

31	30	29	28	27	26	25	24
I	O	E	-	-	-	-	-

with :

- I** : Invalidity, the sample is invalid if equal to 1
- A** : Age, used in slow mode, this sample is validated
- E** : Extrapolated, the sample is the result of an extrapolation if equal to 1.

FORMat:DINTerchange

(Command/Query)

The **FORM:DINT** <1|0|ON|OFF> command activates or inhibits the trace transfer in DIF format.

■ ON|1 activates the trace transfer in DIF format.

■ OFF|0 the trace transfer data is raw.

To the question **FORM:DINT?**, the device returns the activation status of the DIF format.

Response format: DIF format:

(DIF (VERsion <year.version>)

DIMension=X (TYPE IMPLicit

SCALE <sample interval>

SIZE <sample no>

U N ITs "S") DIMension=Y

(TYPE EXPLicit

SCALE <ADC step> SIZE 262144

OFFSet 393216

U N ITs "V")

DATA(CURVe (<data block>)))<NL>

<year.version> is a number in <NR2> format giving the year of the SCPI standard used and the software version.

: 1999.1 means that SCPI version 1999 is used. This is the first software version of the remote control management program.

<sample interval > is a number in <NR3> format.

It represents the time difference between two samples.

<sample no> is a number in <NR1> format.

It represents the number of samples to be transferred.

It can vary from 1 to 2500.

<ADC step> is a number in <NR3> format.

It represents the difference in volt between two consecutive values of the analogue digital converter.

<data block> is a block containing the samples. This data comprises only the values resulting from the analogue digital converter. This block is in the format specified by the **FORMat[:DATA]** command.

FORMat[:DATA]

(Command/Query)

The **FORM** <INTEger|ASCii|HEXadecimal|BINary> command selects the data format of the trace transfer.

- **INTEger**: The data transmitted consists in whole numbers, unsigned with a length of 32 bits, preceded by the heading #an. n represents the number of data items to transmit. a gives the number of figures making up n.

The transmission for 4 data items (74, 70, 71, 76) is #14JFGL

- **ASCii**: The data is transferred using ASCII characters according to <NR1> numbering from 0 to 255. Each number is separated by a comma.

The transmission for 4 data items (74, 70, 71, 76) is 74,70,71,76

- **HEXadecimal**: The data is transferred using ASCII characters according to a numbering in base 16 on 8 bits. Each number is preceded by #H and separated by a comma.

The transmission for 4 data items (74, 70, 71, 76) is #H4A,#H46,#H47,#H4C

- **BINary**: The data is transferred using ASCII characters according to a numbering in base 2 on 8 bits. Each number is preceded by #B and separated by a comma.

The transmission for 4 data items (74, 70, 71, 76) is # B1001010,#B1000110,#B1000111,# B1001100
To the question **FORM?**, the device returns the format selected for the trace transfer.

36.6.2. CONFIGURATION

MMEMory:STORe:STATe (Command)

The **MMEM:STOR:STAT** command generates a ".CFG" file from the instrument configuration, in the selected file system.

To the question **MMEM:STOR:STAT?** The instrument returns the configuration file name which has been created.

Response format: <file name><NL>

MMEMory:LOAD:STATe (Command)

The **MMEM:LOAD:STAT** <"file.CFG"> command loads an instrument configuration from a ".cfg" file. <"file"> consists in a name of 20 letters maximum, followed by a period and the CFG extension.

SYSTem:SET

(Command/Query)

The **SYST:SET** <block> command transfers the configuration from the computer to the device.

<block> is a finite data number preceded by the heading #an with n, the data number and a, a figure indicating the number of figures making up n.

To the question **SYST:SET?**, the device transfers the current configuration to the computer.

Response format: <block> <NL>

36.7. UTILITIES

MMEMory:CATalog?

(Query)

To the question **MMEM:CAT?** the device returns the list of files present in the local memory.

Response format: <file number>, 0[,<file list>] <file number> is in **NR1** format.

<file list> = <"file">,<type>,<size>

<"file"> consists in a name of 20 letters maximum, followed by a period and the 3-letter extension.

<size> is in **NR1** format

<type> is

- STAT for a config file
- TRAC for a trace file
- ASC for a text file
- BIN for any other file

MMEMory:DELeTe

(Command)

The **MMEM:DEL** <"file"> command deletes a file.

<"file"> consists in a name of 20 letters maximum, followed by a period and the 3-letter extension.

MMEMory:DATA

(Command/Query)

The **MMEM:DATA** <"file">,<block> command transfers a file from the PC to the device. <"file"> consists in a name of 20 letters maximum, followed by a period and the 3-letter extension. If the file already exists, it will be overwritten by the new file. The text files (".txt") cannot be imported from the PC to the device. <block> is all of the data in the file preceded by the heading #an, n being the data number and a, a figure indicating the number of figures making up n. To the question **MMEM:DATA?** <"file">, the device transfers the file named to the PC. Response format: <block> <NL>

36.7.1. HARDCOPY

HCOPY:SDUMp
[:IMMEDIATE]

(Command/Query)

The **HCOP:SDUM** command starts a hard copy. To the question **HCOP:SDUM?**, the instrument returns the '.BMP' file name which has been created.

36.7.2. CONFIGURATION

DEVice:MODE

(Command/Query)

The **DEV:MOD** <SCOPE|ANALYSer|REcorder|MULTimeter> command selects the principal mode of the instrument. To the question **DEV:MOD?**, the instrument returns the mode in which it has been configured.

SYSTem:LANGuage

(Command/Query)

The command **SYST:LANG**<en-GB|fr-FR|it-IT|es-ES|de-DE|su-SE|fi-FI|pt-PT|fa-IR|nl-NL|tr-TR|ro-RO|sc-CZ|pl-PL|ko-KR|ru-RU|th-TH> selects one of the 17 languages proposed on the instrument. If the language selected is not installed on the instrument, an error -151 (Invalid string data) is returned and the current language is unchanged. To the question **SYST:LANG?**, the instrument returns the IETF code corresponding to the current language.

Code	Language
en-GB	English
fr-FR	French
it-IT	Italian
es-ES	Spanish
de-DE	German
su-SE	Swedish
fi-FI	Finnish
pt-PT	Portuguese
fa-IR	Farsi
nl-NL	Dutch
tr-TR	Turkish
ro-RO	Romanian
sc-CZ	Czech
pl-PL	Polish
ko-KR	Korean
ru-RU	Russian
th-TH	Thai

36.7.3. RUN/STOP

INITiate:CONTinuous
:NAME

(Command)
The **INIT:CONT:NAME <{EDGE|PULse}>,<1|0|ON|OFF>** command starts or stops the acquisition in repetitive mode in the indicated trigger mode.

ABORt

(Command)
The **ABOR** command aborts the acquisition in progress.

- If the instrument is set in the **single** mode, the acquisition is stopped. The instrument stays in the starting status.
- If the instrument is in **continuous** mode, the acquisition in progress is stopped and the following starts.

 Note: if no acquisition is running, this command has no effect.

TRIGger[:SEQuence
{[1]|2}] :RUN:STATe

(Command/Query)
The **TRIG:RUN:STAT <1|0|ON|OFF>** command starts or stops the acquisition.

- **ON|1** acquisition starts.
- **OFF|0** acquisition is stopped.

 To the question **TRIG:RUN:STAT?**, the instrument returns the trigger status.

36.7.4. AUTOSET

AUTOSet:EXEcute

(Command)
The **AUTOS:EXE** command starts an autotest on each active channel.

36.7.5. AUTOTEST

The self test can be started from the oscilloscope mode only, otherwise an error "-221: conflict settings" appears.

SYSTem :AUTOTest

(Command/Query)
The **SYST:AUTOT** command launches an autotest of the instrument.
 To the question **SYST:AUTOT?** the instrument returns the result of the autotest in hexadecimal. The signification of the code returned is the following : the value 1 of each bit shows that the test is OK.

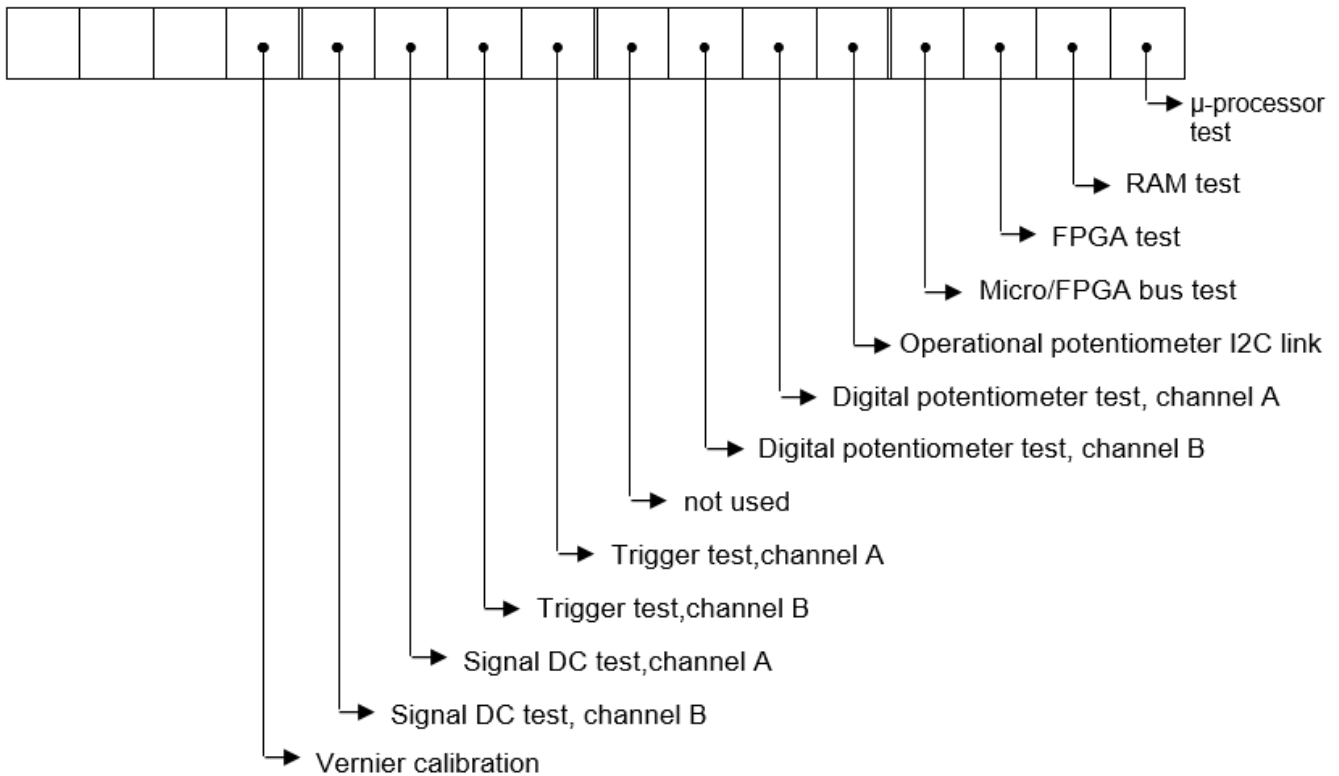

36.8. HELP

HELP[?]

(Query)

To the question **HELP? [« directory entry »]** the instrument answers helping in the SCPI commands available.

« **directory entry** » is a key word (short or long form) of first level in the tree of the command. No distinction is made between small and capital letters.

In absence of parameter, the list of the key words accepted by the function is given. When a key word is introduced, the list and the syntax of all the commands starting with this word is returned by the function.

37. COMMANDS SPECIFIC TO THE INSTRUMENT "MULTIMETER MODE"

37.1. VERTICAL

INPut{[1]|2|3|4}:DMM
:COUPling

(Command/Query)

The **INP{[1]|2}:DMM:COUP <AC|DC|ACDC>** command affects the coupling of the selected channel. To the question **INP{[1]|2}:DMM:COUP?** the instrument returns the current coupling of the selected channel.

INPUT{[1]|2|3|4}:DMM
:BANDwidth:AUTO

(Command/Query)

The **INP{[1]|2}:DMM:BAND:AUTO <1|0|ON|OFF>** command limits the bandwidth of the channel to 5 kHz.

To the question **INP{[1]|2}:DMM:BAND:AUTO?** the instrument shows if the 5 kHz bandwidth limit is active.

[SENSe]:RANGe
{[1]|2|3|4}:AUTO

(Command/Query)

The **RANG{[1]|2}:AUTO <1|0|ON|OFF>** command authorizes or prohibits the autoranging of the selected channel.

■ **ON|1** activates the autoranging.

■ **OFF|0** deactivates this function.

To the question **RANG{[1]|2}:AUTO?** the instrument returns the autoranging status for the selected channel.

[SENSe]:RANGe[1]:CAPA (Command/Query)

The **RANG:CAPA <range|MAX|MIN|UP|DOWN>** command selects the range of measurement to be used in capacitance mode.

<range> is a value in format **NRf**, it may be followed or not by a multiple and by the unit.

By default, the value is expressed in Farad.

To the question **RANG:CAPA?** the instrument returns the range value of the capacitance.

Response format: <range><NL>

value in format **<NR3>**

SENSe]:RANGe[1]:OHM (Command/Query)

The **RANG:OHM <range|MAX|MIN|UP|DOWN>** command selects the measurement range to be used in ohmmeter mode.

<range> is a value in format **NRf**, it may be followed or not by a multiple and by the unit.

By default, it is expressed in Ohm (Ω).

To the question **RANG:OHM?** the instrument returns the value of the measurement range of the ohmmeter.

Response format: <range><NL>

value in format **<NR3>**

[SENSe]:RANGe
{[1]|2|3|4}:VOLT

(Command/Query)

The **RANG{[1]|2|3|4}:VOLT <range|MAX|MIN|UP|DOWN>** command selects the measurement range to be used in voltmeter mode for the selected channel.

<range> is a value in **NRf** format, it may be followed or not by a multiple and by the unit.

By default, it is expressed in volt.

To the question **RANG{[1]|2|3|4}:VOLT?** the instrument returns the value of the measurement range of the voltmeter for the selected channel.

Response format: <range><NL>

value in format **<NR3>**

37.2. RECORDING TIME

[SENSe]:SWEep:TIME[?] (Command/Query)

The **SWE:TIME** <time|MAX|MIN|UP|DOWN> command sets the recording time. <time> is a value in **NRf** format and may be followed or not by a multiple of the unit. By default, it is expressed in second. To the question **SWE:TIME?** the instrument returns the recording time.
Response format: <time><NL>
value in the <NR3>

37.3. MEASUREMENT

MEASure:DMM?

(Query)

To the question **MEAS:DMM?** <INT1|2|5> the instrument returns the value of the main measurement for the selected channel.
INT5 is associated to power measurement.

[SENSe]:FUNctioN

(Command/Query)

FUNC <VOLTage|RESistance|CONTinuity|CAPAcitor|DIODE|RPM|POWer|POW3PN|POW3P> selects the measurement function on channel 1.
To the question **FUNC?**, the instrument returns the measure function to channel 1.

37.4. ERROR

SYSTem:ERRor[:NEXT]? (Query)

To the question **SYST:ERR?**, the instrument returns the number of error positioned at the top of the queue. The queue has a stack of 20 numbers and is managed as follows : first in, first out. As the **SYST:ERR?** question arrive, the instrument returns the number of errors in order of arrival, until the queue is empty. Every more **SYST:ERR?** question involves a negative answer: character "0" (ASCII 48code). If the queue is full, the case at the top of the queue takes the value -350 (saturated queue).
The queue is empty:
- when the instrument is getting started.
- at the receipt of a *CLS.
- at the reading of the last error.
Response format: <error><NL>

with error = negative or 0, no error.

37.4.1. * COMMAND ERROR: (-199 TO -100)

They indicate that a syntax error has been detected by the syntax analyzer and causes event register bit 5, called CME, CoMmand Error to be set to 1.

-101	:	Invalid character
-103	:	Invalid separator
-104	:	Data type error
-108	:	Parameter not allowed
-109	:	Missing parameter
-111	:	Header separator error
-112	:	Program mnemonic too long
-113	:	Undefined header
-114	:	Header suffix out of range
-121	:	Invalid character in number
-128	:	Numeric data not allowed
-131	:	Invalid suffix
-138	:	Suffix not allowed
-141	:	Invalid character data
-148	:	Character data not allowed
-151	:	Invalid string data
-154	:	String data too long
-171	:	Invalid expression

37.4.2. EXECUTION ERRORS: (-299 TO -200)

They indicate that an error has been detected at the moment of command execution and causes event register bit 4, called EXE, Execution Error, to be set to 1.

-200	:	Execution error
-213	:	Init ignored
-221	:	Settings conflict
-222	:	Data out of range
-232	:	Invalid format
-256	:	File name not found
-257	:	File name error

37.4.3. * SPECIFIC INSTRUMENT ERRORS: (-399 TO -300)

They indicate that an abnormal error has been detected during execution of a task, and causes event register bit 3, called DDE, Device Dependent Error to be set to 1.

-300	:	Device-specific error
-321	:	Out of memory
-350	:	Queue overflow
-360	:	Communication error

37.4.4. * QUERY ERRORS: (-499 TO -400)

They indicate that an abnormal error has been detected during execution of a task, and cause event register bit 2, called QYE, Query Error, to be set to 1.

-400	:	Query error
------	---	-------------

38. IEEE 488.2 COMMON COMMANDS

38.1. INTRODUCTION

The common commands are defined by the IEEE 488.2 standard. They are operational on all instruments which are specified IEEE 488.2. They command basic functions such as:

- identification,
- reset,
- configuration reading,
- reading of event and status register,
- reset of event and status register.

If a command containing one or several directories has been received, and if a common command has been stacked up, then the instrument stays in this directory and execute normally the commands.

38.2. EVENTS AND STATUS MANAGEMENT

38.2.1. REGISTERS

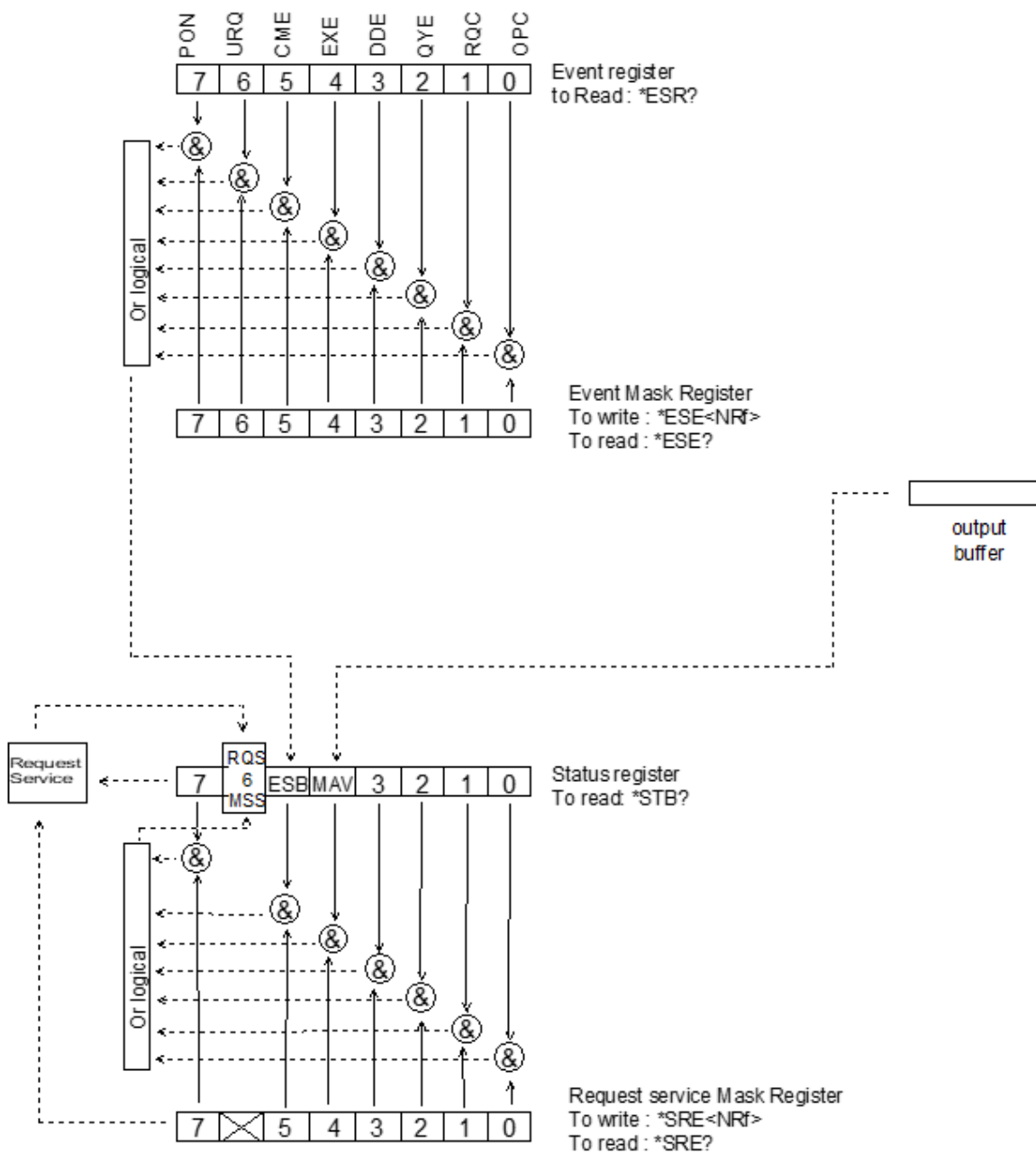

38.2.2. STATUS REGISTERS

Reading only → *STB? common command.

In this case, the (MSS) 6 Bit is returned and remain in the status it was before reading [see §. *STB (Status Byte)]

The *CLS common command is reset to zero.

Delaited description

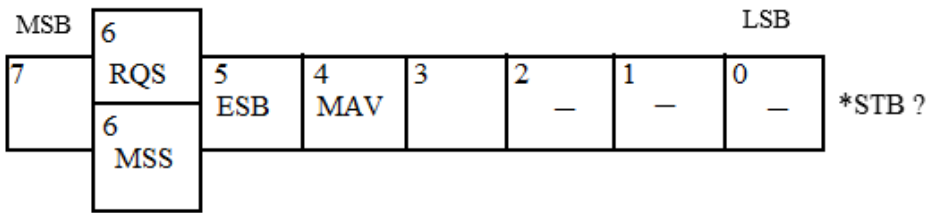

RQS Request Service (6 bit)

Indicates if the instrument requests a service. The type of COMM used on the instrument does not generate a request, but the byte is accessible in reading. It is reset to 0 after reading and can switch to zero only if the event register is reset to zero (by reading or *CLS).

MSS Master Summary Status (6 bit)

Indicates if the instrument has a reason to request a service. This information is accessible only in reading the status register. (*STB? command) and stays as it is after the reading.

ESB Event Satus Bit (5 bit)

Indicates if at least one of the conditions of the event register is satisfied and not masked.

MAV Message Available (4 bit)

Indicates if at least one response is in the output spooler.

38.2.3. SERVICE REQUEST MASK REGISTER

Reading and writing → *SRE command.

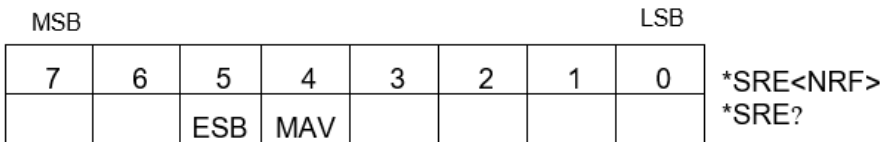

38.2.4. EVENT REGISTER

Reading → *ESR command. Its reading resets to zero.

Detailed description

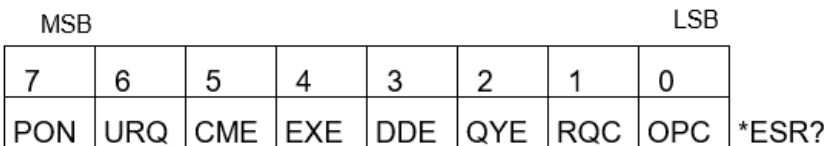

PON Power On (7 bit)

Not used

URQ User request (6 bit)

Not used

CME Command Error (5 bit)

A command error has been detected.

EXE Execution Error (4 bit)

An error execution has been detected.

- DDE Device Dependant Error 3 (bit)**
An error specific to the instrument has been detected.
- QYE Query Error (2 bit)**
A query error has been detected.
- RQC Request Control (1bit)**
Always at zero.
- OPC Operation Complete (0 bit)**
All operations running are ended.

38.2.5. EVENT MASK REGISTER

Reading and writing → *ESE command.

MSB								LSB	
7	6	5	4	3	2	1	0	*ESE<NRF>	
PON	URQ	CME	EXE	DDE	QYE	RQC	OPC	*ESE?	

38.3. IEEE 488.2 COMMANDS

***CLS**
(Clear Status) (Command)
The common command *CLS reset the status and event register.

***ESE**
(Event Status Enable)
(Command/Query)
The *ESE <mask> common command positions the status of the event mask.
<mask> is a value in format <NR1>, from 0 to 255.
A 1 authorises the corresponding bit of the event register to generate an event, while a 0 masks it.
To the question *ESE?, the instrument returns the current content of the event mask register.
Response format: <value><NL>
value in format <NR1> from 0 to 255.

Event mask register:

MSB								LSB
7	6	5	4	3	2	1	0	
PON	URQ	CME	EXE	DDE	QYE	RQC	OPC	

***ESR?**
(Event Status Register)
(Query)
To the question *ESR?, the instrument returns the content of the event register.
Once the register has been read, the content value is reset to zero.
Response format: <value><NL>
value in format <NR1> from 0 to 255.

Event register:

MSB								LSB
7	6	5	4	3	2	1	0	
PON	URQ	CME	EXE	DDE	QYE	RQC	OPC	

***IDN?**

(Identification Number)

(Query)

To the question ***IDN?**, the instrument returns the type of instrument and the software version.

Response format:

<instrument>,<firmware version>/<hardware version>,<serial number<NL>

<instrument>	Instrument name (CA922 or CA942)
<firmware version>	Software version
<hardware version>	PCB version
<serial number>	Instrument serial number

***OPC**

(Operation Complete)

(Command/Query)

The command ***OPC** authorises the setting to 1 of the OPC bit in the event register as soon as the current operation is completed.

To the question ***OPC?**, the instrument returns the character ASCII "1" as soon as the current operation is terminated.

***RST**

(Reset)

(Command)

The command ***RST** reconfigures the instrument with the factory settings.

***SRE**

(Service Request Enable)

(Command/Query)

The command ***SRE <mask>** positions the service request mask register.

<mask> is a value in format **<NR1>**, from 0 to 255.

A value of bit at 1 enables the same-rank bit of the status register to request a service (bit of the status register contains 1). A bit value at 0 neutralizes it.

To the question ***SRE?**, the instrument returns the value of the service demand mask register.

Response format: <value><NL>

value in format **<NR1>** from 0 to 255.

Service demand mask register:

MSB				LSB			
7	6	5	4	3	2	1	0
0	0	ESB	MAV	0	0	0	0

***STB?**

(Status Byte)

(Query)

To the question ***STB?** the instrument returns the content of its status register (Status Byte Register).

The bit 6 returned indicates the MSS value (Master Summary Status) (at 1 if the instrument has a reason for requesting a service).

Contrary to RQS, it is not reset to zero after reading the status register (RQS is accessible only by series recognition, and falls to 0 at its end).

Status register:

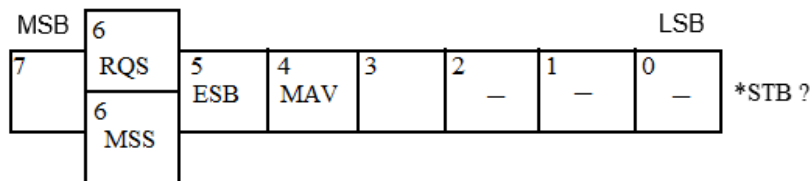

***TRG**

(Command)

The command ***TRG** starts an acquisition in the current mode "single" or "continuous".

***TST?**
(Test)

(Query)

To the question ***TST?**, the instrument returns the status of the autotest procedure.

Response format: <0|1><NL>

- responds 0 when the autotest is successful.
- responds 1 when a problem has been detected.

***WAI**
(Wait)

(Command)

The command ***WAI** prevents the instrument from performing further commands as long as the current command has not been terminated. This enables to synchronize the instrument with the application program in progress on the controller.

38.4. TREE STRUCTURE

38.4.1. IEEE 488.2 COMMON COMMANDS

Commands	Functions
*CLS	Resets the status and event registers
*ESE	Writes event mask
*ESE?	Reads event mask
*ESR?	Reads event register
*IDN?	Reads identifier
*OPC	Validates bit OPC
*OPC?	Waits till end of execution
*RST	Resets
*SRE	Writes service request mask
*SRE?	Reads service request mask
*STB?	Reads status register
*TRG	Starts an acquisition in the current mode
*TST?	Returns the status of the autotest procedure
*WAI	Commands synchronization

39. SCPI COMMANDS

Directory	Commands + parameters
ABORt	
AUTOSet	:EXEcute
CALCulate	:MATH[:EXPRession][:DEFine] <(function)>,<(multiplier)> :MATH[:EXPRession][:DEFine]?
DEVIce	:MODE <SCOPE ANALYSer MULTimeter> :MODE?
DISPlay	[:WINDow]:CURSor:REFerence <INT{1 2 3}> [:WINDow]:CURSor:REFerence? [:WINDow]:CURSor:STATe <1 0 ON OFF> [:WINDow]:CURSor:STATe? [:WINDow]:CURSor:TIME{[1] 2}:POSition <position MAX MIN> [:WINDow]:CURSor:TIME{[1] 2}:POSition? [:WINDow]:CURSor:VOLT{[1] 2}:POSition? [:WINDow]:TRACe:FORMat <A XY> [:WINDow]:TRACe:FORMat? [:WINDow]:TRACe:MODE <ENVELOPE ALL> [:WINDow]:TRACe:MODE? [:WINDow]:TRACe:STATe{[1] 2 3} <1 0 ON OFF> [:WINDow]:TRACe:STATe{[1] 2 3}? [:WINDow]:TRACe:X[:SCALe]:PDIVision <scale MAX MIN UP DOWN> [:WINDow]:TRACe:X[:SCALe]:PDIVision? [:WINDow]:TRACe:Y:LABel{[1] 2} <"label"> [:WINDow]:TRACe:Y:LABel{[1] 2 3}? [:WINDow]:TRACe:Y[:SCALe]:PDIVision{[1] 2} <scale MAX MIN> [:WINDow]:TRACe:Y[:SCALe]:PDIVision{[1] 2}?
FORMat	:DINTerchange <1 0 ON OFF> :DINTerchange? [:DATA] <INTeger ASCii HEXadecimal BINary> [:DATA]?
HCopy	:SDUMp[:IMMediate] :SDUMp[:IMMediate]?
HELP	[?] <directory-entry> [?]
INITiate	:CONTInuous:NAME {EDGE PULse},<ON OFF 1 0> [:IMMediate]:NAME {EDGE PULse}
INPut	INPut{[1] 2}:COUPling <AC DC GROund> INPut{[1] 2}:COUPling? INPut{[1] 2}:DMM:BANDwidth:AUTO <1 0 ON OFF> INPut{[1] 2}:DMM:BANDwidth:AUTO? INPut{[1] 2}:DMM:COUPling <AC DC ACDC> {[1] 2}:DMM:COUPling?

MEASure	:AC? <INT{1 2 3}>
	:AMPLitude? <INT{1 2 3}>
	:AUTO <1 0 ON OFF>
	:AUTO?
	:CURSor:DTIME?
	:CURSor:DVOLT?
	:DMM? <INT{1 2 5}>
	:FALL:OVERshoot? <INT{1 2 3}>
	:FALL:TIME? <INT{1 2 3}>
	:FREQuency? <INT{1 2 3}>
	:FTIME? <INT{1 2 3}>
	:HIGH? <INT{1 2 3}>
	:LOW? <INT{1 2 3}>
	:MAXimum? <INT{1 2 3}>
	:MINimum? <INT{1 2 3}>
	:NWIDth? <INT{1 2 3}>
	:PDUTYcycle? <INT{1 2 3}>
	:PERiod? <INT{1 2 3}>
	:PHASe? <INT{1 2}>
	:PTPeak? <INT{1 2 3}>
	:PULse:COUNT? <INT{1 2 3}>
	:PWIDth? <INT{1 2 3}>
	:RISE:OVERshoot? <INT{1 2 3}>
	:RISE:TIME? <INT{1 2 3}>
	:RTIME? <INT{1 2 3}>
	{[1 2 3]:SELECT <NO MIN MAX PTPeak LOW HIGH AMPLitude ROVERshoot FOVERshoot RTIME FTIME PWIDth FWIDth FREQuency PERiod PDUTYcycle COUNT RMS AVG PHASE>,<measure2>MEASure{[1 2 3]:SELECT?
	:VOLT[:DC]? <INT{1 2 3}>
MMEMory	:CATalog?
	:DATA <"file">,<block>
	:DATA? <"file">
	:DELeTe <"file">
	:LOAD:STATe <"file.CFG">
	:LOAD:TRACe <"file.TRC">
	:STORE:STATe
	:STORE:STATe?
	:STORE:TRACe <INT{1 2 3} REF{1 2 3}>,<"TRC" "TXT">
	:STORE:TRACe?

SENSe	:AVERAge:COUNT <0 2 4 16 64 MAX MIN UP DOWN>
	:AVERAge:COUNT?
	:AVERAge:TYPE <NORMal ENVELOpe>
	:AVERAge:TYPE?
	:BANDwidth{[1] 2}[:RESolution] <bandwidth>
	:BANDwidth{[1] 2}[:RESolution]?
	:BANDwidth{[1] 2}[:RESolution]:AUTO <1 0 ON OFF>
	:BANDwidth{[1] 2}[:RESolution]:AUTO?
	:FUNCTion[1]<VOLTag RESistance CONTinuity CAPAcitor DIODE RPM POWer POW3PN POW3P>
	:FUNCTion[1]?
	:RANGe{[1] 2}:AUTO <1 0 ON OFF>
	:RANGe{[1] 2}:AUTO?
	:RANGe[1]:CAPA <range MAX MIN UP DOWN>
	:RANGe[1]:CAPA?
	:RANGe[1]:OHM <range MAX MIN UP DOWN>
	:RANGe[1]:OHM?
	:RANGe{[1] 2}:VOLT <range MAX MIN UP DOWN>
	:RANGe{[1] 2}:VOLT?
	:SWEep:OFFSet:TIME <time MAX MIN UP DOWN>
	:SWEep:OFFSet:TIME?
	:SWEep:TIME <time MAX MIN UP DOWN>
	:SWEep:TIME?
	:VOLTag{[1] 2 3}[:DC]:RANGe:OFFSet <offset MAX MIN UP DOWN>
	:VOLTag{[1] 2 3}[:DC]:RANGe:OFFSet?
:VOLTag{[1] 2}[:DC]:RANGe:PTPeak <sensitivity MAX MIN UP DOWN>	
:VOLTag{[1] 2 3}[:DC]:RANGe:PTPeak?	
SYSTem	:AUTOTest
	:AUTOTest?
	:ERRor[:NEXT]?
	:LANGUage <ENGLISH FREnch GERman SPANish ITALian>
	:LANGUage?
	:SET <block>
	:SET?
TRACe	:CATalog?
	[:DATA]? <INT1 2 3>
	:LIMit <limit1>,<limit2>,<step>
	:LIMit?

TRIGger	[:SEQuence{[1]2}]:ATRIGger[:STATe] <1 0 ON OFF>
	[:SEQuence{[1]2}]:ATRIGger[:STATe]?
	[:SEQuence{[1]2}]:DEFine?
	[:SEQuence{[2]}]:DELay <delay MAX MIN UP DOWN>
	[:SEQuence{[2]}]:DELay?
	[:SEQuence{[1]2}]:FILTer:HPASs[:STATe] <1 0 ON OFF>
	[:SEQuence{[1]2}]:FILTer:HPASs[:STATe]?
	[:SEQuence{[1]2}]:FILTer:LPASs[:STATe] <1 0 ON OFF>
	[:SEQuence{[1]2}]:FILTer:LPASs[:STATe]?
	[:SEQuence{[1]2}]:HYSTeresis <1 3>
	[:SEQuence{[1]2}]:HYSTeresis?
	[:SEQuence{[1]2}]:LEVel <level MAX MIN UP DOWN>
	[:SEQuence{[1]2}]:LEVel?
	[:SEQuence{[1]2}]:RUN:STATe <1 0 ON OFF>
	[:SEQuence{[1]2}]:RUN:STATe?
	[:SEQuence{[1]2}]:SLOPe <POSitive NEGative>
	[:SEQuence{[1]2}]:SLOPe?
	[:SEQuence{[1]2}]:SOURce <INTernal{1 2}>
	[:SEQuence{[1]2}]:SOURce?
	[:SEQuence[2]]:TYPE <EQUate SUPerior INFerior>
	[:SEQuence[2]]:TYPE?

FRANCE

Chauvin Arnoux

12-16 rue Sarah Bernhardt

92600 Asnières-sur-Seine

Tél : +33 1 44 85 44 85

Fax : +33 1 46 27 73 89

info@chauvin-arnoux.com

www.chauvin-arnoux.com

INTERNATIONAL

Chauvin Arnoux

Tél : +33 1 44 85 44 38

Fax : +33 1 46 27 95 69

Our international contacts

www.chauvin-arnoux.com/contacts

