

Instruction Manual

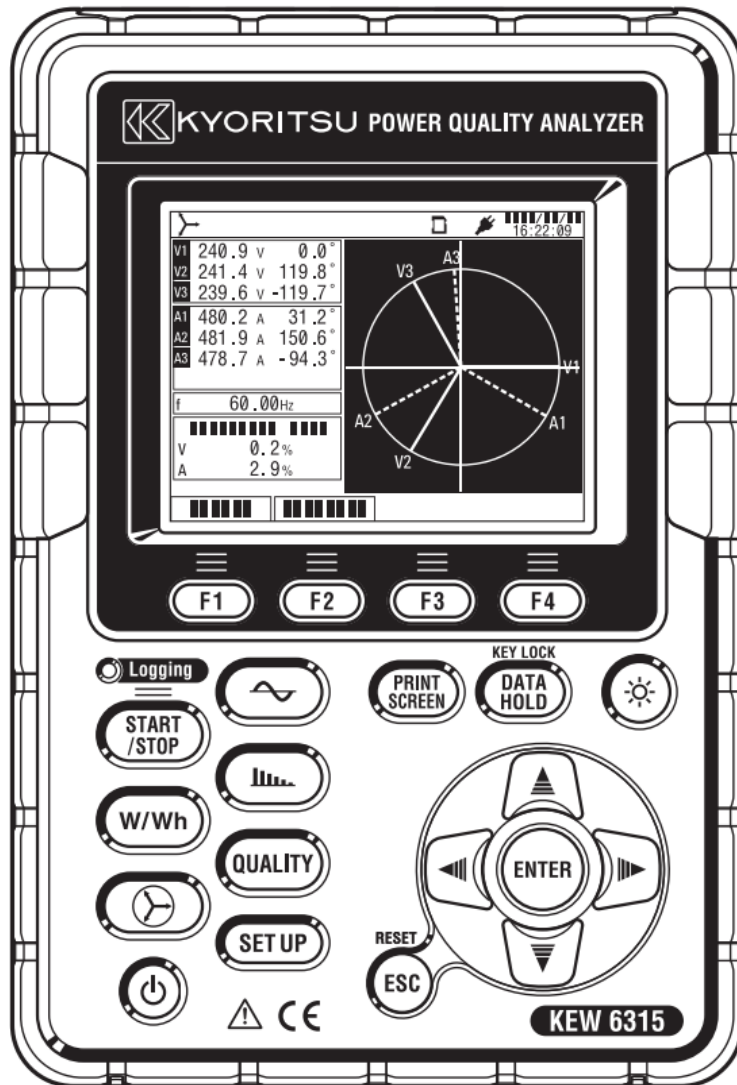

Power Quality Analyzer

KEW6315



**KYORITSU ELECTRICAL
INSTRUMENTS WORKS, LTD.**

Contents	1
Unpacking Procedure	5
Safety warnings	8
Chap. 1 Instrument overview	11
1.1 Functional overview	11
1.2 Features	13
1.3 Constructional drawing	14
1.4 Steps for measurement	15
Chap.2 Instrument layout.....	16
2.1 Display (LCD)/ Keys.....	16
2.2 Connector.....	17
2.3 Side face	18
2.4 Voltage test lead and Clamp sensor.....	19
Chap.3 Basic operations	20
3.1 Key operation	20
3.2 Icons on the LCD	21
3.3 Symbols on the LCD	22
3.4 Backlight and Contrast Adjustment.....	22
3.5 Screens.....	23
● Inst/ Integration/ Demand.....	23
● Vector	24
● Waveform.....	24
● Harmonic Analysis.....	25
● Power quality	26
● Settings.....	26
Chap.4 Getting started	27
4.1 Preparation	27
● Putting Input terminal plate on the Input terminal	27
● Attaching Markers to Voltage test leads and Clamp sensors	28

4.2	Power Supply	29
●	Battery	29
●	Battery Mark on the LCD/ Battery level	30
●	How to install batteries	31
●	Power cord connection	31
●	Power supply rating	32
4.3	Placing / removing SD card	33
●	Inserting SD card	34
●	Removing SD card	34
4.4	Voltage test leads and Clamp sensor connection	35
4.5	Start KEW6305	36
●	Start-up Screen	36
●	Cautionary message	36
4.6	Recording procedures	37
●	Start of recording	37
●	End of recording	38
●	Start measurement with “Quick start guide”	39
Chap.5	Settings	47
5.1	List of setting items	47
5.2	Basic setting	48
●	Settings of wiring system	49
●	Wiring connection	51
●	Settings of voltage measurement	53
●	VT/CT	54
●	Settings of current measurement	56
●	Settings of External input terminal/ reference frequency	58
5.3	Measurement setting	59
●	Settings of demand measurement	59
●	Outline of demand measurement concept	62
●	Settings for Harmonic analysis	63
●	Threshold setting for Power quality (Event)	65

●	Filter setting for Flicker measurement	69
●	Target power factor for Capacitance calculation	70
5.4	Recording setting	71
●	Settings for recording items	72
●	Saved items	73
●	Recording method	74
●	Possible recording time	76
5.5	Other settings	77
●	Settings for system environment	77
●	KEW6315 Setting	79
5.6	Saved data	82
●	To delete, transfer or format the recorded data	82
●	Type of the saved data	87
●	KEW6315 settings and Data loading	89
Chap. 6	Displayed items	92
6.1	Instantaneous value “W”	92
●	List display of the measured values	92
●	Zoom display	96
●	Displaying Trend graph	97
●	Changing displayed items and display position	99
6.2	Integration value “Wh”	100
6.3	Demand	102
●	Showing the measured values	102
●	Shifts in specific period	103
●	Demand change	104
6.4	Vector	105
6.5	Waveform	107
6.6	Harmonics	108
●	Displaying harmonics on the bar graph	108
●	Displaying the list of harmonics	112

6.7	Power quality	114
●	Factors impair power quality and symptoms	114
●	Displaying recorded events	116
●	Displaying measured flicker values in list form	120
●	Displaying trend graph of Pst, 1min	121
●	Displaying changes of Plt	122
Chap.7	Other functions	123
Chap.8	Device connection	125
8.1	Data transfer to PC	125
8.2	Using Bluetooth® function	126
8.3	Signal control	126
●	Connection to input/ output terminals	126
8.4	Getting power from measured lines	128
Chap. 9	PC software for setting and data analysis	129
Chap.10	Specification	130
10.1	Safety requirements	130
10.2	General specification	130
10.3	Measurement specification	133
●	Measured items and the number of analysis points	133
●	Items measured at Instantaneous measurement	134
●	Items to be calculated	137
●	Items measured at Integration measurement	140
●	Items measured at Demand measurement	143
●	Items measured at Harmonics measurement	144
●	Items measured at Power quality measurement	149
10.4	Specification of Clamp sensor	152
Chap. 11	Troubleshooting	157
11.1	General troubleshooting	157
11.2	Error messages and actions	158

Unpacking procedure

We thank you for purchasing our Power Quality Analyzer “KEW6315”. Please check the contents and instrument before use.

- Items listed below are included with the standard set:

1	Main unit	KEW6315 :1 pce
2	Voltage test lead	MODEL7255 :1 set *red, white, blue, black: 1 pce for each (with alligator clips)
3	Power cord	MODEL7169 :1 pce
4	USB cord	MODEL7219 :1 pce
5	Quick manual	1 pce
6	CD-ROM	1 pce
7	Battery	Alkaline size AA battery LR6: 6 pcs
8	SD card	M-8326-02 :1 pce (2GB)
9	Carrying case	MODEL9125 :1 pce
10	Input terminal plate	1 pce
11	Cable marker	8-color x 4pcs each (red, blue, yellow, green, brown, gray, black, white)

Optional parts

12	Clamp sensor	Depending on model purchased
13	Instruction manual for Clamp sensor	1 pce
14	Magnetic carrying case	MODEL9132
15	Power supply adapter	MODEL8312(CAT. III 150V, CAT. II 240V)

1. Main unit

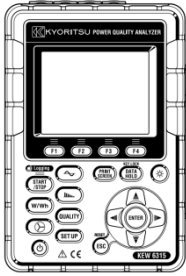

2. Voltage test lead

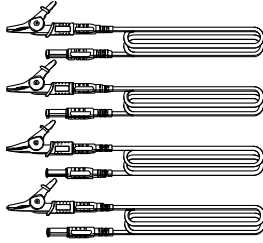

3. Power cord

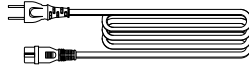

4. USB cord



5. Quick manual



6. CD-ROM

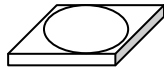

7. Battery



8. SD card

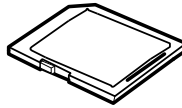

2GB

M-8326-02

9. Carrying case

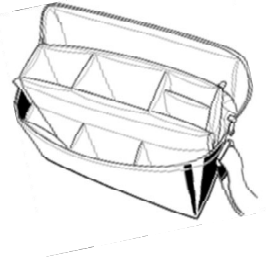

10. Input terminal plate

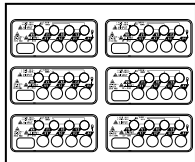

11. Cable marker

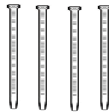

12. Clamp sensor (depending on model purchased)

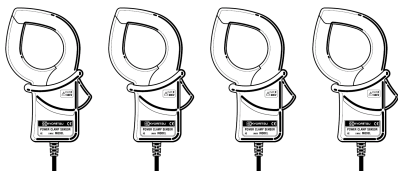

50A Type(ø24mm)	M-8128
100A Type(ø24mm)	M-8127
200A Type(ø40mm)	M-8126
500A Type(ø40mm)	M-8125
1000A Type(ø68mm)	M-8124
3000A Type(ø150mm)	M-8129
1000A Type(ø110mm)	M-8130
10A Type(ø24mm)	M-8146
10A Type(ø40mm)	M-8147
10A Type(ø68mm)	M-8148
1A Type(ø24mm)	M-8141
1A Type(ø40mm)	M-8142
1A Type(ø68mm)	M-8143

13. Instruction manual for Clamp sensor

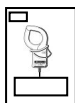

14. Magnetic carrying case

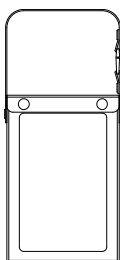

15. Power supply adapter

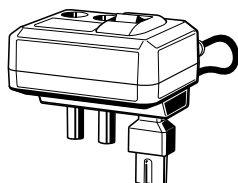

● Storage

Store the items as shown below after use.

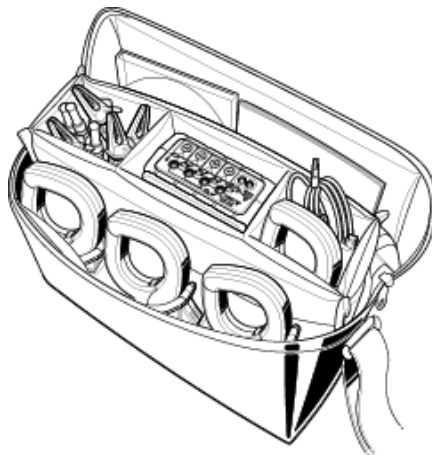

● In case any of the items listed above are found to be damaged or missing or if the printing is unclear, please contact your local KYORITSU distributor.

Safety warnings

This instrument has been designed, manufactured and tested according to IEC 61010-1: Safety requirements for Electronic Measuring apparatus, and delivered in the best condition after passing quality control tests.

This instruction manual contains warnings and safety procedures which have to be observed by the user to ensure safe operation of the instrument and to maintain it in safe condition. Therefore, read through these operating instructions before starting to use the instrument.



WARNING

- For about Instruction manual -

- Read through and understand the instructions contained in this manual before using the instrument.
- Keep the manual at hand to enable quick reference whenever necessary.
- The instrument is to be used only in its intended applications.
- Understand and follow all the safety instructions contained in the manual.
- Read the enclosed Quick manual after reading this instruction manual.
- As to the Clamp sensor use, refer to the instruction manual supplied with the sensor.

It is essential that the above instructions are adhered to. Failure to follow the above instructions may cause injury, instrument damage and/or damage to equipment under test. Kyoritsu assumes no responsibility for damage and injury caused by misuse or not following the instructions in the manual.

The symbol  indicated on the instrument, means that the user must refer to the related parts in the manual for safe operation of the instrument. It is essential to read the instructions wherever the symbol appears in the manual.

- | | | |
|---|----------------|--|
|  | DANGER | : is reserved for conditions and actions that are likely to cause serious or fatal injury. |
|  | WARNING | : is reserved for conditions and actions that can cause serious or fatal injury. |
|  | CAUTION | : is reserved for conditions and actions that can cause injury or instrument damage. |

Measurement Category

To ensure safe operation of measuring instruments, IEC 61010 establishes safety standards for various electrical environments, categorized as O to CAT.IV, and called measurement categories. Higher-numbered categories correspond to electrical environments with greater momentary energy, so a measuring instrument designed for CAT.III environments can endure greater momentary energy than one designed for CAT.II.

- O : Circuits which are not directly connected to the mains power supply.
- CAT.II : Electrical circuits of equipment connected to an AC electrical outlet by a power cord.
- CAT.III : Primary electrical circuits of the equipment connected directly to the distribution panel, and feeders from the distribution panel to outlets.
- CAT.IV : The circuit from the service drop to the service entrance, and to the power meter and primary overcurrent protection device (distribution panel).

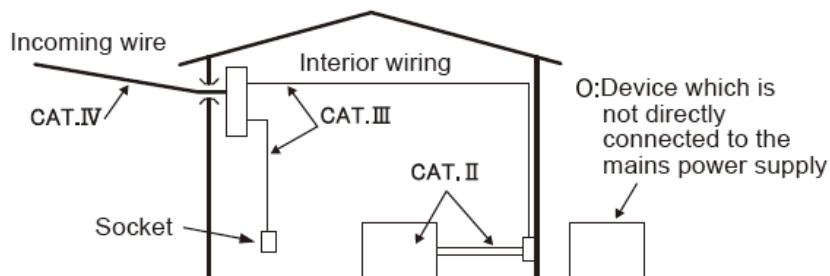

 **DANGER**

- The instrument is to be used only in its intended applications or conditions. Otherwise, safety functions equipped with the instrument will not work, and instrument damage or serious personal injury may occur. Verify proper operation on a known source before taking action as a result of the indication of the instrument.
- With attention to the measurement category to which the object under test belongs, do not make measurements on a circuit in which the electrical potential exceeds the following values.
* 300V AC for CAT. IV, 600V AC for CAT. III, 1000V AC for CAT. II
- Do not attempt to make measurement in the presence of flammable gasses. Otherwise, the use of the instrument may cause sparking, which can lead to an explosion.
- Never attempt to use the instrument if its surface or your hand is wet.

- Measurement -

- Do not exceed the maximum allowable input of any measuring range.
- Never open the Battery compartment cover during a measurement.

- Battery -

- Do not try to replace batteries during a measurement.
- Brand and type of the batteries to be used should be harmonized.

- Power cord -

- Connect the Power cord to an outlet.
- Use only the Power cord supplied with this instrument.

- Power supply connector -

- Never touch the Power supply connector although it is insulated while the instrument is operating with batteries.

- Voltage test leads -

- Use only the ones supplied with this instrument.
- Choose and use the test leads and caps that are suitable for the measurement category.
- When the instrument and the test lead are combined and used together, whichever lower category either of them belongs to will be applied. Confirm that the measured voltage rating of the test lead is not exceeded.
- Do not connect a Voltage test lead unless required for measuring the desired parameters.
- Connect Voltage test leads to the instrument first, and only then connect them to the circuit under test.
- Keep your fingers behind the barrier during a measurement.
Barrier: provides protection against electrical shock and ensuring the minimum required air and creepage distances.
- Never disconnect the voltage test leads from the connectors of the instrument during a measurement (while the instrument is energized).
- Do not touch two lines under test with the metal tips of the test leads.
- Never touch the metal tips of the test leads.

- Clamp sensor -

- Use only the ones dedicated for this instrument.
- Confirm that the measured current rating of the test lead and the maximum rated voltage are not exceeded.
- Do not connect a Clamp sensor unless required for measuring the desired parameters.
- Connect sensors to the instrument first, and only then connect them to the circuit under test.
- Keep your fingers behind the barrier during a measurement.
Barrier: provides protection against electrical shock and ensuring the minimum required air and creepage distances.

- Never disconnect sensors from the connectors of the instrument while the instrument is in use.
- Connect to the downstream side of a circuit breaker since a current capacity at the upstream side is large.
- Do not touch two lines under test with the metal tips of the test leads.

⚠ Caution

- Caution should be taken since conductors under test may be hot.
- Never apply currents or voltages exceeding the maximum allowable input for the instrument for a long time.
- Do not apply currents or voltages for the Clamp sensors or Voltage test leads while the instrument is off.
- Don't use the instrument at dusty places or to be spattered.
- Don't use the instrument under a strong electric storm or in the vicinity of energized object.
- Never give strong vibrations or drop shocks.
- Insert an SD card to the slot with the top side turned up. If the card is inserted up-side-down, the SD card or the instrument may be damaged. Confirm the
- While using an SD card, do not replace or remove the card. (The  symbol blinks while accessing SD card.) Otherwise, the saved data in the card may be lost or the instrument may be damaged.

- Clamp sensor -





- Do not bend or pull the cable of the Clamp sensor.

- Treatment after use -

- Power off the instrument and disconnect the Power cord, Voltage test leads and Clamp sensors from the instrument.
- Remove the batteries if the instrument is to be stored and will not be in use for a long period.
- Remove the SD card when carrying the instrument.
- Never give strong vibrations or drop shocks when carrying the instrument.
- Do not expose the instrument to direct sunlight, high temperatures, humidity or dew.
- Use a damp cloth with neutral detergent or water for cleaning the instrument. Do not use abrasives or solvents.
- Do not store the instrument if it is wet.

Carefully read and follow the instructions: **⚠ DANGER**, **⚠ WARNING**, **⚠ CAUTION** and **NOTE** () described in each section.

Meaning of symbols on the instrument:

	User must refer to the explanations in the instruction manual.
	Instrument with double or reinforced insulation
	AC
	(Functional) Earth terminal

Chap. 1 Instrument overview

1.1 Functional overview

Start/ Stop

Choose either “Quick start guide” or “Start now” to start recording. Can do simple and fast start-up setting by selecting “Quick start guide”.

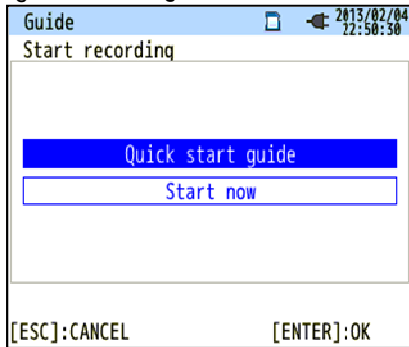

See “4.6 Recording procedures” (P.37) for further details.

Inst/ Integration/ Demand

Display the avg/ max/ min instantaneous values of current/ voltage/ active power/ apparent power/ reactive power. Integration values also can be viewed by switching screens. Moreover, demand values with the preset target value can also be checked.

The screenshot shows a screen titled 'W/Wh' with a date and time display (2013/06/05 13:42:05). It displays a table of parameters for three channels (1ch, 2ch, 3ch) and an 'Inst' section. The 'Inst' section has sub-sections for 'Avg', 'Max', and 'Min'. At the bottom, there are buttons for 'Wh', 'Zoom', 'Trend', and 'Customize'.

	1ch	2ch	3ch		
V :	596.7	445.6	499.1		
A :	49.9	39.6	44.8		
P :	29.78	17.68	26.78		
Q :	20.03	10.65	20.39		
S :	29.78	17.68	26.78		
PF :	0.798	0.785	0.793		
P :	91.95	kW	f :	60.00	Hz
Q :	57.23	kvar			
S :	91.95	kVA			
PF :	0.809	A4 :	39.6	A	
DC1 :	0	mV	DC2 :	-0	mV
				02:14	/50min

See “6.1 Inst “W” (P.92), 6.2 Integration “Wh” (P.100), 6.3 Demand (P.102)” for further details.

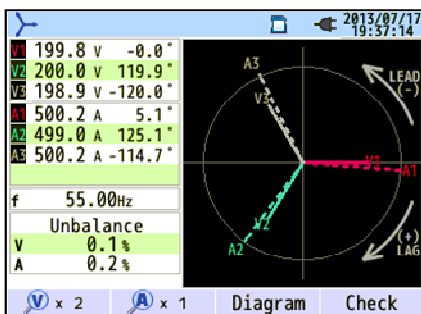

Vector and Wiring check

Vectors of voltage and current per CH are displayed on a graph. Executing wiring check function is possible from this screen.

See “6.4 Vector” (P.105) for further details.

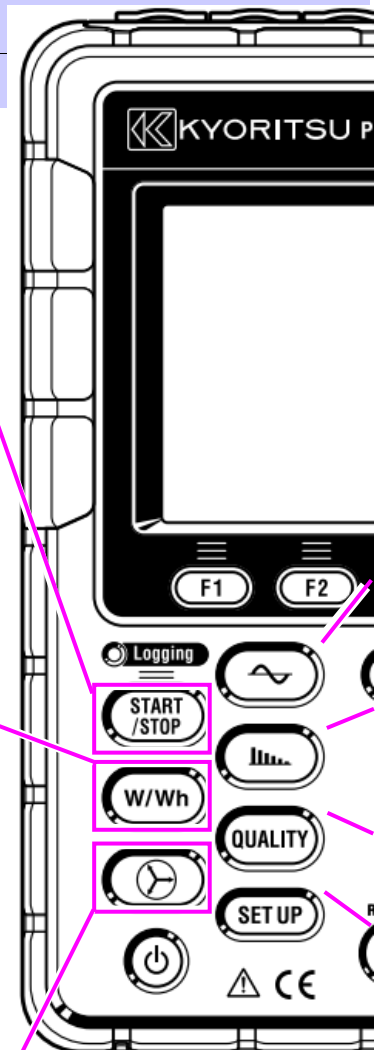

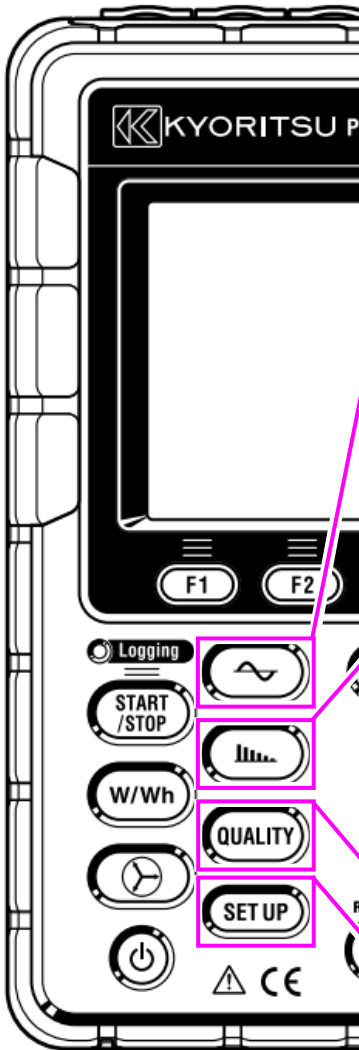

Waveform

Waveforms of voltage and current per CH are displayed on a graph.

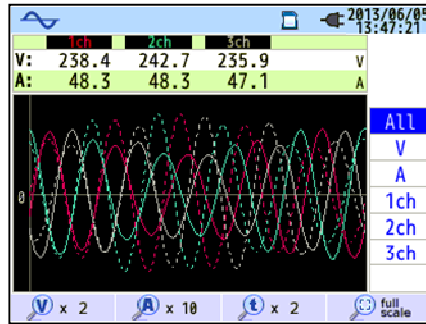

See "6.5 Waveform" (P.107) for further details.

Harmonic Analysis

Harmonic components of voltage and current per CH are displayed on a graph.

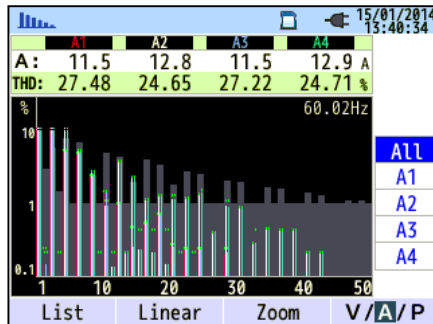

See "6.6. Harmonics" (P.108) for further details.

Setting (SET UP)

Adjust settings of KEW6315 and measurements.

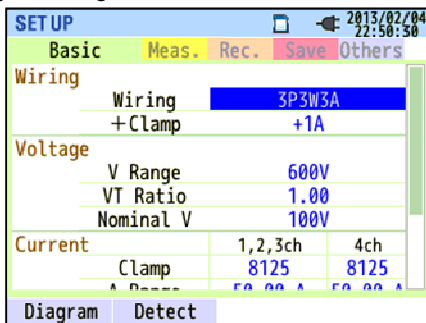

See "5. Settings" (P.47) for further details.

Power Quality (QUALITY) event

Display voltage swell, dip, int, transient, inrush current and flicker.

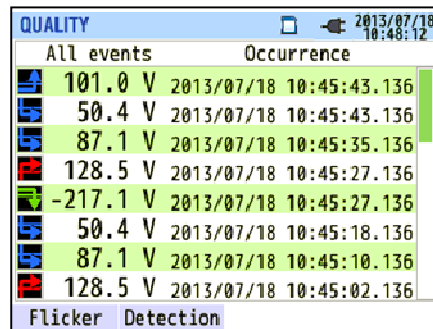

See "6.7. Power Quality" (P.114) for further details.

1.2 Features

This is a Clamp-type Power Quality Analyzer that can be used for various wiring systems. It can be used for simple measurements of instantaneous/ integration/ demand values, and also for analysis of harmonics and events related to power quality and for the simulation of power factor correction with capacitor banks. Moreover, it can display waveforms and vectors of voltage and current. Data can be saved either on the SD card or in the internal memory, and can be transferred to PC via USB, or in real time via Bluetooth[®] communication.

Safety construction

Designed to meet the international safety standard IEC 61010-1 CAT.IV 300V/ CAT.III 600V/ CAT.II 1000V.

Power quality analysis

KEW6315 is designed to meet the international standard IEC61000-4-30 Class S and can measure frequency and r.m.s. voltage with high accuracy, and also can analyze harmonics. Moreover, it can measure swell, dip, interruption, transient, inrush current and flicker, gapless, all at once.

Power measurement

KEW6315 measures active/reactive/apparent power, electrical energy, power factor, r.m.s. current, phase angle and neutral current simultaneously.

Wiring configuration

KEW6315 supports: Single-phase 2-wire (4-system), Single-phase 3-wire (2-system), Three-phase 3-wire (2-system) and Three-phase 4-wire.

Demand measurement

Electricity consumption can be easily monitored so as not to exceed the target maximum demand values.

Waveform/ vector display

Voltage and current can be displayed by waveform or vector.

Saving data

KEW6315 is endowed with a logging function with the preset recording interval. Data can be saved by manual operation or by specifying date & time. Screen data can be saved by using the Print Screen function.

Dual power supply system

KEW6315 operates either with AC power supply or with batteries. Size AA alkaline dry-cell batteries and size AA Ni-MH rechargeable batteries can both be used. To charge size AA Ni-MH rechargeable batteries, use the charger which is manufactured by the same company as the batteries. In the event of power interruption, while operating with AC power supply, power to the instrument is automatically restored by the batteries in the instrument.

Large display

TFT color display with large screen.

Light & compact design

Clamp sensor type, compact and light weight design.

Application

Data in the SD card or the internal memory can be saved in PC via USB. Analysis of the downloaded data and instrument settings are possible by using the special software "KEW Windows for KEW6315". Real-time communication with android devices is available via Bluetooth[®].

Input/ Output function

Analog signals from thermometers or light sensors can be measured simultaneously with electrical power data via 2 analog inputs (DC voltage); when any events related to power quality occur, signals can be transmitted to alarm devices via one digital output.

1.3 Constructional drawing

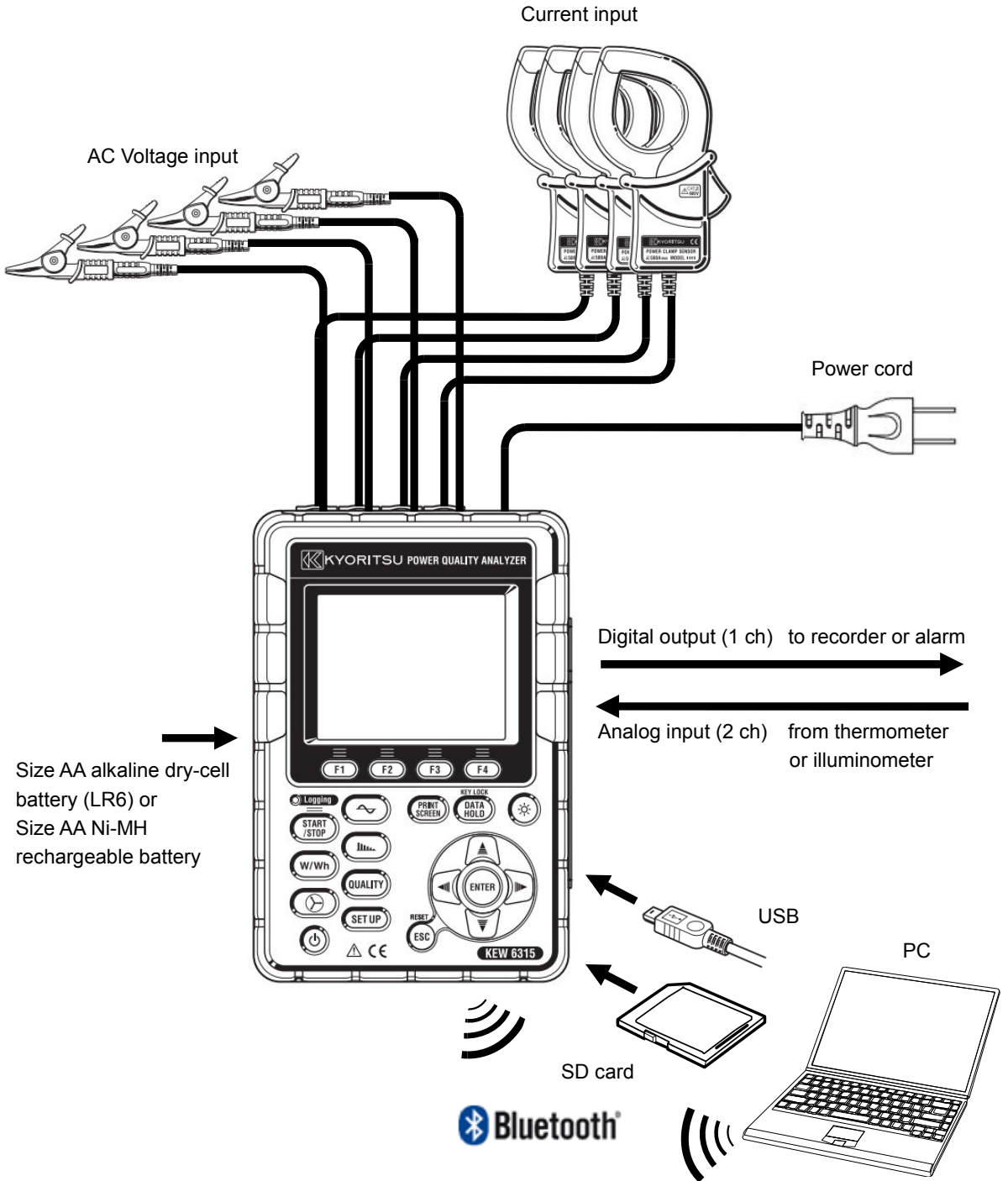

1.4 Steps for measurement

Read through the operating instructions described in “**Safety warnings**” (P.8) before starting to use the instrument.

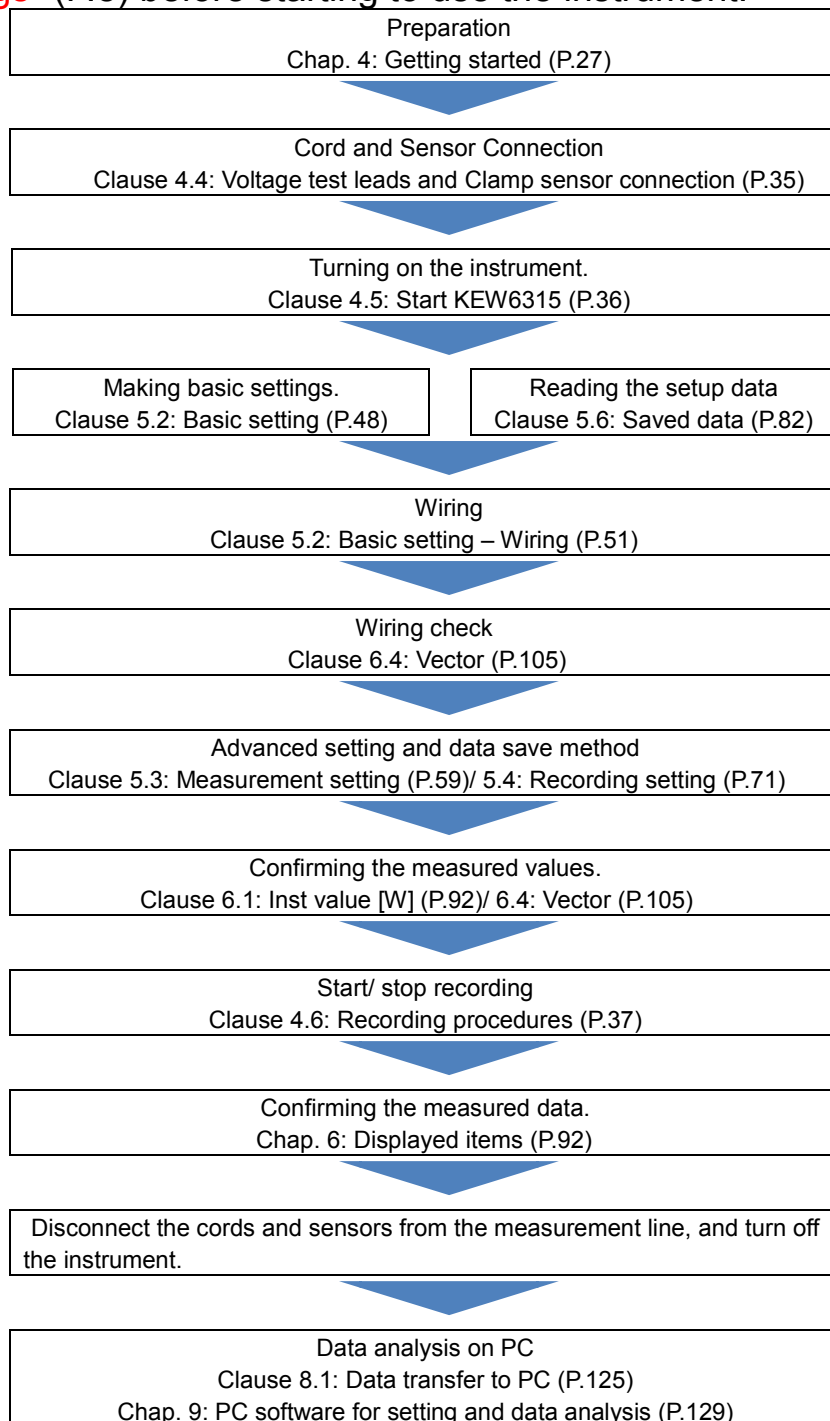

Chap.2 Instrument layout

2.1 Display (LCD)/ Keys

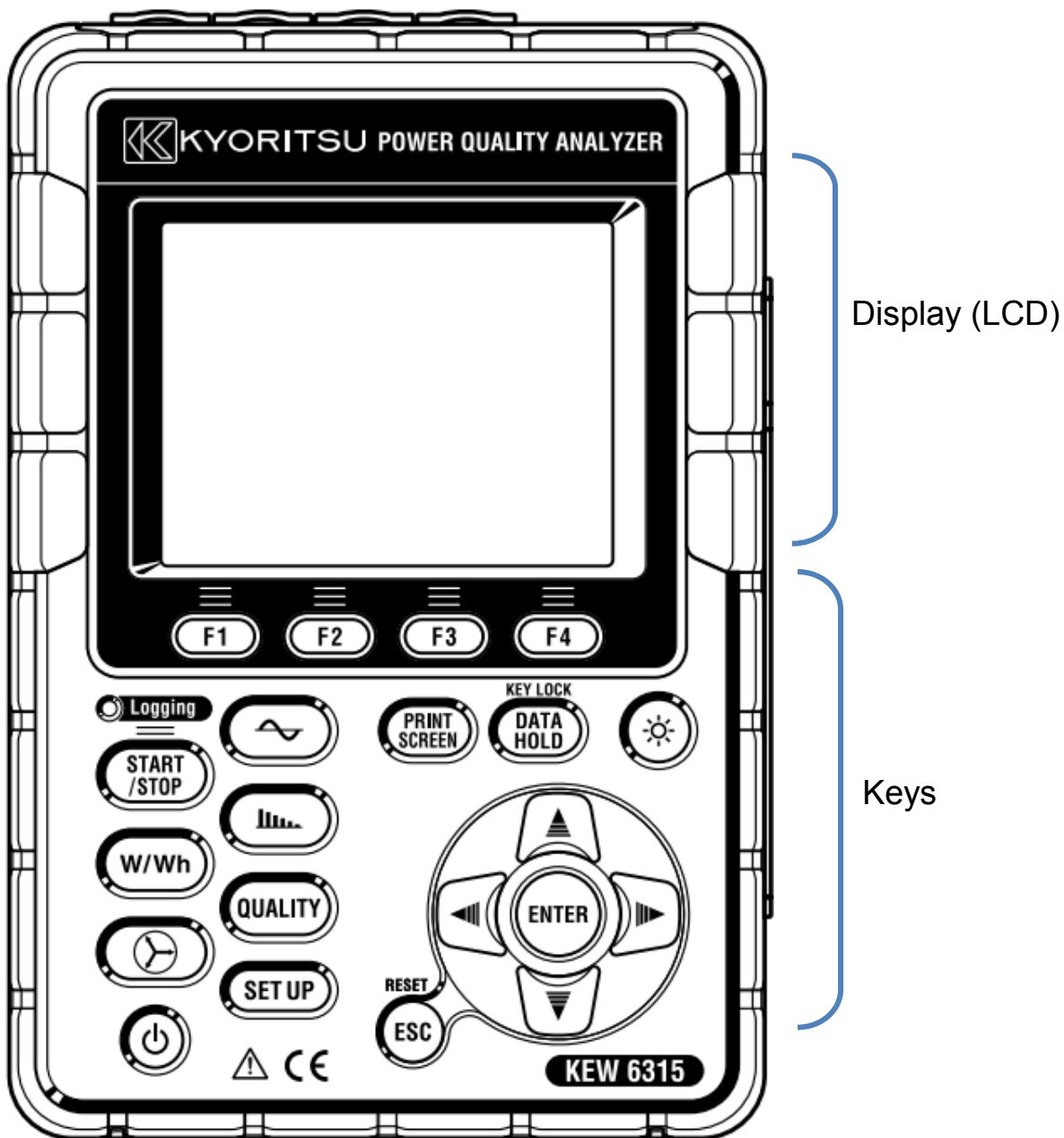

2.2 Connector

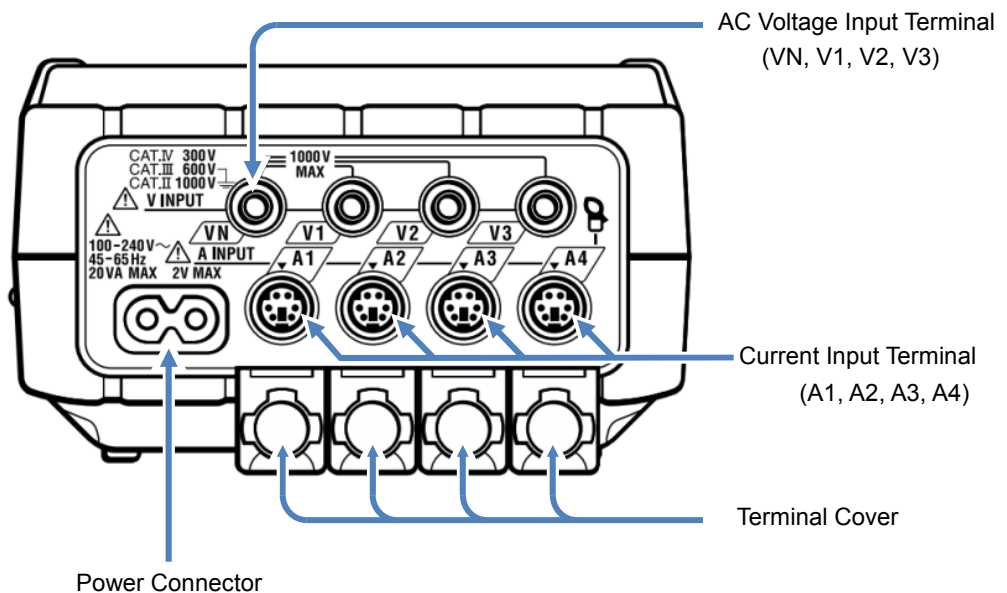

Wiring configuration		AC Voltage Input Terminal	Current Input Terminal*
Single-phase 2-wire (1-system)	1P2W×1	VN, V1	A1
Single-phase 2-wire (2-system)	1P2W×2	VN, V1	A1, A2
Single-phase 2-wire (3-system)	1P2W×3	VN, V1	A1, A2, A3
Single-phase 2-wire (4-system)	1P2W×4	VN, V1	A1, A2, A3, A4
Single-phase 3-wire (1-system)	1P3W×1	VN, V1, V2	A1, A2
Single-phase 3-wire (2-system)	1P3W×2	VN, V1, V2	A1, A2, A3, A4
Three-phase 3-wire (1-system)	3P3W×1	VN, V1, V2	A1, A2
Three-phase 3-wire (2-system)	3P3W×2	VN, V1, V2	A1, A2, A3, A4
Three-phase 3-wire 3A	3P3W3A	V1, V2, V3	A1, A2, A3
Three-phase 4-wire	3P4W×1	VN, V1, V2, V3	A1, A2, A3

* Measurements of r.m.s. values and harmonics are possible at the Current terminals, which are not used for wiring connection.

2.3 Side face

< When the Connector cover is closed. >

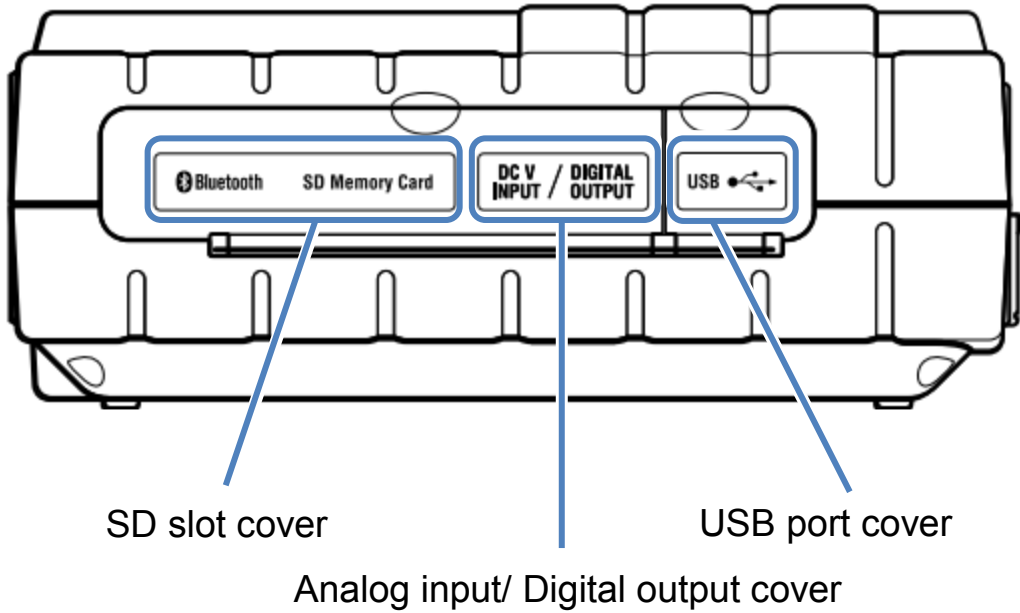

< When the Connector cover is opened. >

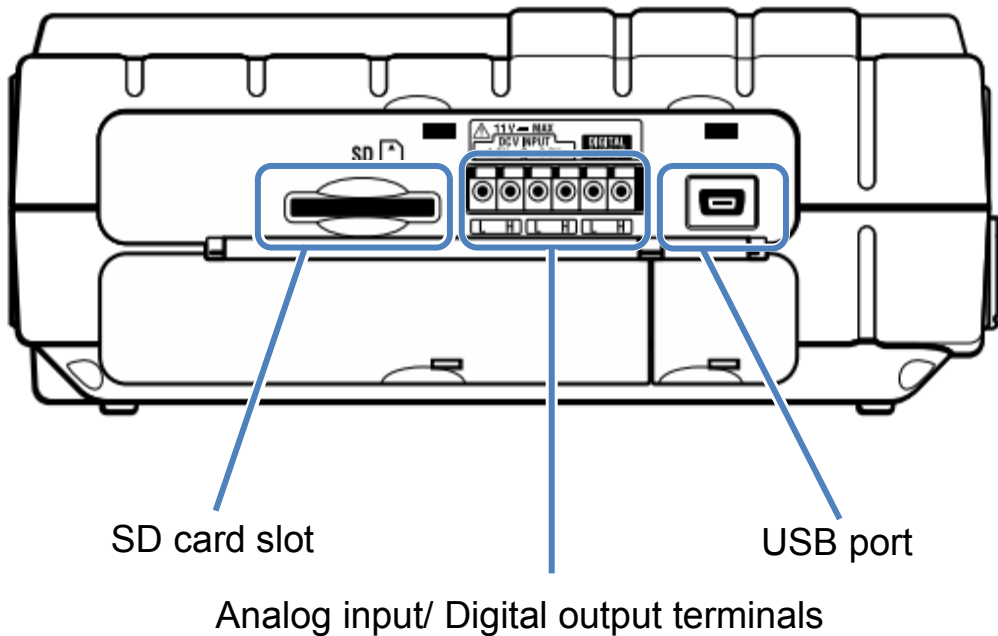

2.4 Voltage test lead and Clamp sensor

<Alligator clip> * Attached to the top part of voltage test lead

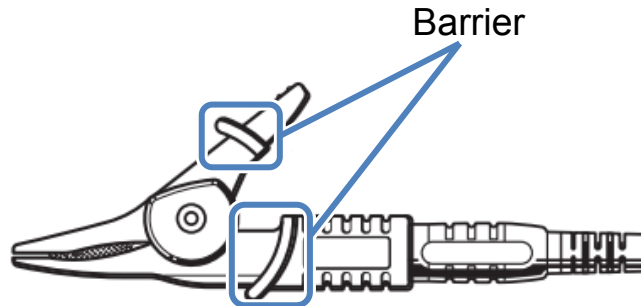

<Clamp sensor>

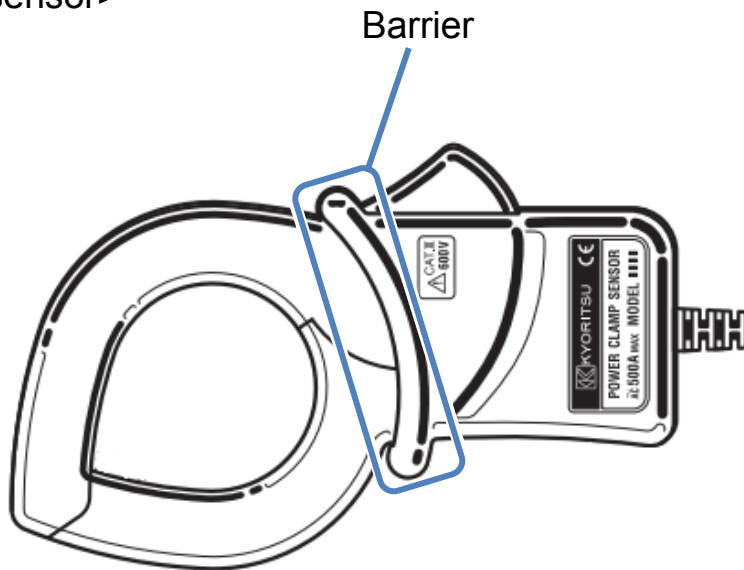

Barrier is a mechanical safety part and provides protection against electrical shock and ensuring the minimum required air and creepage distances. Keep your fingers and hands behind the barrier during a measurement.

3 Basic operations

3.1 Key operation

Function Key

F_ Execute the displayed function.

PRINT SCREEN Key



Save the displayed screen as BMP file.

DATA HOLD Key/ KEY LOCK Key



Hold the readings on the display.
 * Measurement continues while the readings are being held on the display.
 Long press (at least 2 sec) disables all Keys to prevent operational errors. Another long press (at least 2 sec) is required to restore the disabled Keys.



LCD Key



Turn on/ off the backlight.
 Long press (at least 2 sec) changes the brightness and contrast.

Cursor Key

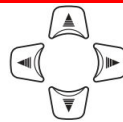

Select items or switch displays.

ENTER Key



Confirm the entries.

ESC Key/ RESET Key



Cancel setting changes and return to the previous settings.

START/ STOP Key



Start/ stop measurement.

Power Key



Power on/ off.

Status LED

Green	Light up: Recording& measuring Blink: Stand-by
Red	Blink: Backlight is off.

SETUP Key









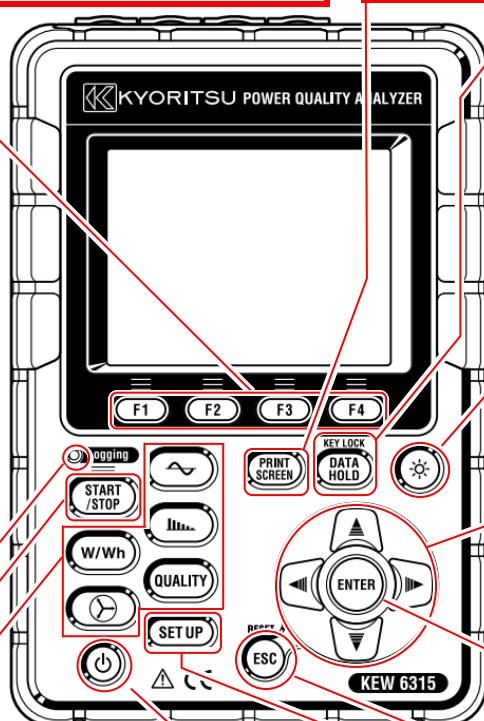









Change and confirm: Basic, Measurement, Recording and other settings, and also edit the saved data.

Menu Key

	WWh	View inst, integration and demand values.		Harmonic Analysis	View harmonic voltage, current and power energy.
	Vector	View phases.		Power Quality	View the detailed info about: swell, dip, int, transient, inrush current and flicker.
	Waveform	View voltage/ current waveforms.			



3.2 Icons on the LCD

Icon	Status
	KEW6315 is operating with battery. This icon varies in 4 steps according to the battery power condition.
	KEW6315 is operating with AC power.
	Holding the display update.
	Keys are locked.
	Buzzer is off.
	SD card is set and available.
	Recording the data on the SD card.
	Available free space in the SD card is not enough.
	Failed to access to the SD card.
	Internal memory is available. * This icon is displayed when a measurement starts without SD card.
	Recording the data in the internal memory.
	Available free space in the internal memory is not enough.
	Stand-by mode
	Recording the measured data.
	Capacity of recording media is full.
	USB is available.
	Bluetooth® is available.

3.3 Symbols on the LCD

V ¹	Phase voltage	VL ¹	Line voltage	A	Current
P	Active power + consumption - regenerating	Q	Reactive power + lagging - leading	S	Apparent power
PF	Power factor + lagging - leading	f	Frequency		
DC1	Analog input voltage at 1ch	DC2	Analog input voltage at 2ch		
An ^{*2}	Neutral current	PA ^{*3}	Phase angle + lagging - leading	C ^{*3}	Capacitance calculation
WP+	Active power energy (consumption)	WS+	Apparent power energy (consumption)	WQi+	Reactive power energy (lagging)
WP-	Active power energy (regenerating)	WS-	Apparent power energy (regenerating)	WQc+	Reactive power energy (leading)
THD	Voltage/ Current total distortion factor				
Pst (1min)	Voltage flicker (1 min)	Pst	Short term voltage flicker	Plt	Long term voltage flicker

¹ W screen: Displays of V and VL can be “customized” when “3P4W” is selected.

² W screen: “An” is displayed only when “3P4W” is selected.

³ W screen: Displays of PA and C can be “customized”.

3.4 Backlight and Contrast Adjustment

Hold down the “” **LCD** Key at least 2 sec to show the sliding bar to adjust the backlight brightness and display contrast. Use the **Cursor** Key to slide the cursor on the bar for the adjustment. Press the **ENTER** Key and exit from the adjustment mode. Press the **ESC** or **LCD** Key again to cancel the adjustment and exit from the adjustment mode.



Brightness adjustment

Backlight brightness can be changed by 11 levels.

Contrast adjustment

Contrast can be changed by 11 levels.

3.5 Screens

Inst/ Integration/ Demand

W/Wh Switching screens

Press the **F1** key to toggle the screens.

W (Inst value)

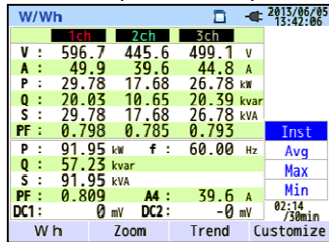

Wh (Integration value)

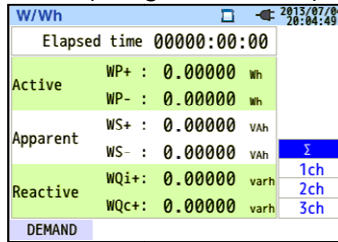

Demand

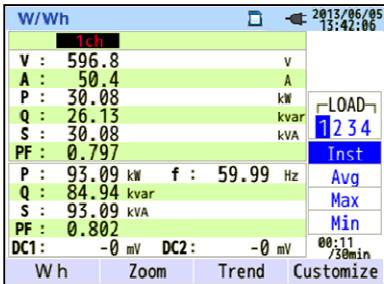
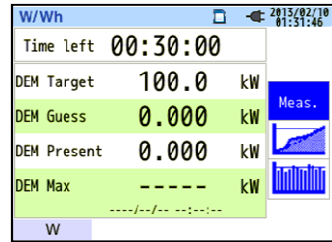

Customize
Select and change the items to be displayed.

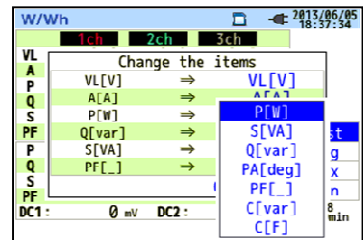
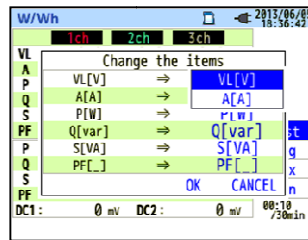

Trend

Changes of measured values are displayed on a graph.

Zoom

Zoom and display the selected items.

4-split

8-split

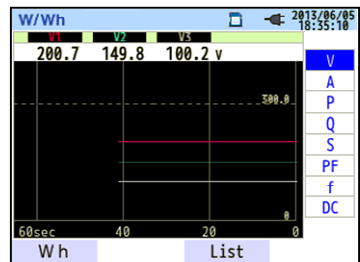
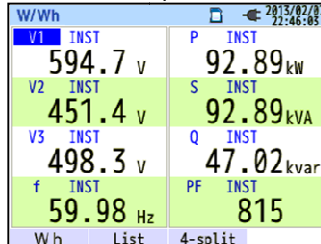
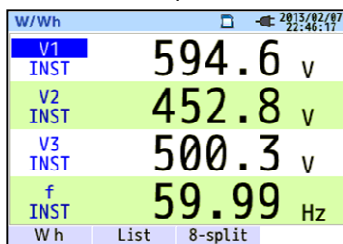

Vector

Switching screens

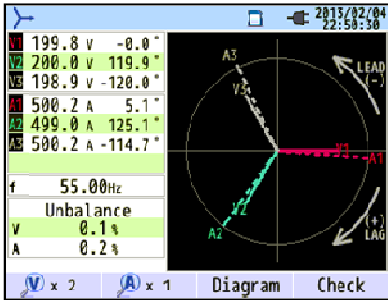

Wiring diagram

Diagram of the selected wiring is displayed.

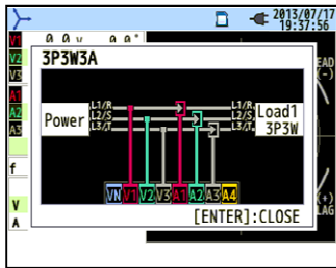

Wiring check
Checked results will be displayed.

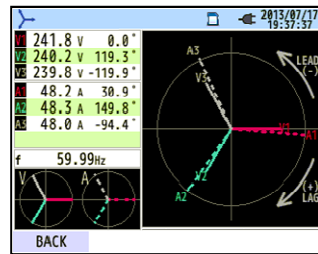
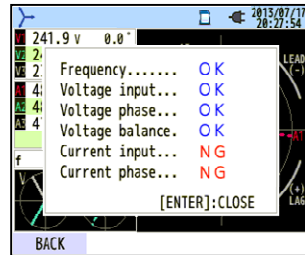

Waveform

Switching screens

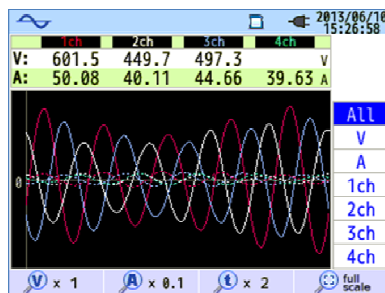

Harmonics



Switching screens

Voltage, Linear, Overall display

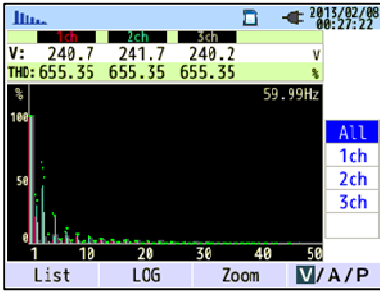

Current

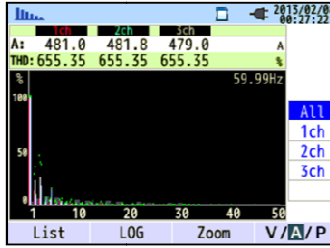

Power

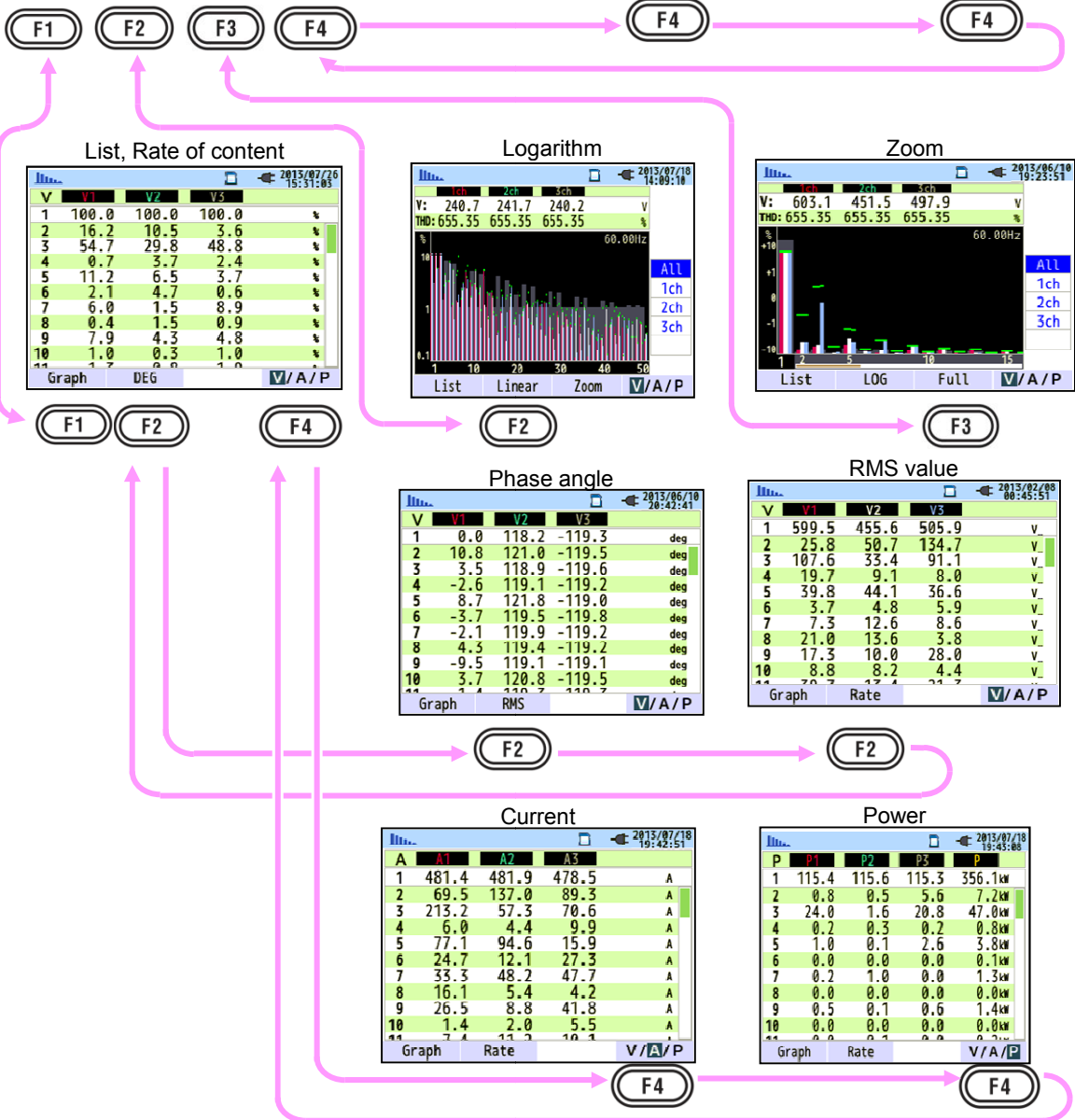
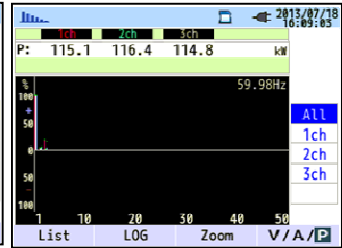

Power quality

QUALITY Switching displayed items

Event

QUALITY	All events	Occurrence
101.0 V	2013/07/18	10:45:136
50.4 V	2013/07/18	10:45:43.136
87.1 V	2013/07/18	10:45:35.136
128.5 V	2013/07/18	10:45:27.136
-217.1 V	2013/07/18	10:45:27.136
50.4 V	2013/07/18	10:45:18.136
87.1 V	2013/07/18	10:45:10.136
128.5 V	2013/07/18	10:45:02.136

Flicker Detection

Flicker

Pst Calc. ...			
1ch	2ch	3ch	
V :	230.0	230.4	230.5 V
Pst:	0.804	1.028	1.017
Pst:	0.804	1.026	1.022
MAX	0.804	1.035	1.034
PLt:	0.804	1.027	1.025
MAX	0.804	1.028	1.028
f : 59.99 Hz			

Event



Settings

SETUP Switching displayed items

Toggle the screens with the **Cursor** Key. (right or left)

4 Getting started

4.1 Preparation

Putting Input terminal plate on the Input terminal

Six Input terminal plates are supplied with this instrument. Choose one Plate which matches the standard cord colors where the instrument is used. Put the Plate to the Input terminal observing the orientation.

* Clean the Input terminal before putting the Plate and confirm it isn't wet.

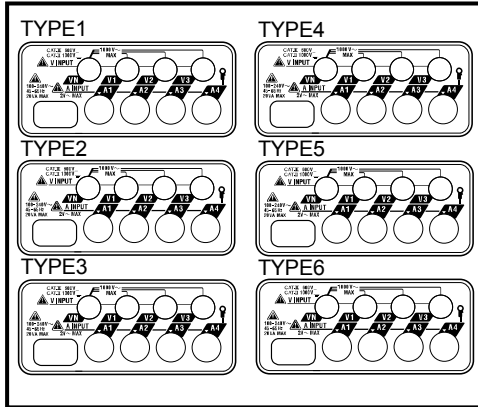

Input terminal plate

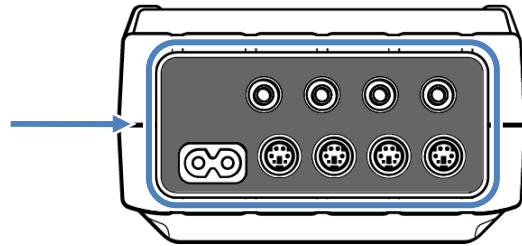

Put a proper Input terminal plate.

	VN	V1/A1	V2/A2	V3/A3	A4
TYPE 1	blue	red	green	black	yellow
TYPE 2	blue	brown	black	gray	yellow
TYPE 3	black	yellow	green	red	white
TYPE 4	blue	black	red	white	yellow
TYPE 5	white	black	red	blue	yellow
TYPE 6	black	red	yellow	blue	white

Attaching Markers to Voltage test leads and Clamp sensors

Attach Markers to the both ends of the Voltage test leads and Clamp sensors harmonized with the Input terminals. * Supplied Markers are 32 pcs in total : 4pcs each color (red, blue, yellow, green, brown, gray, black, white).

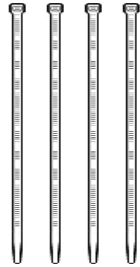

Marker (32 pcs in total)

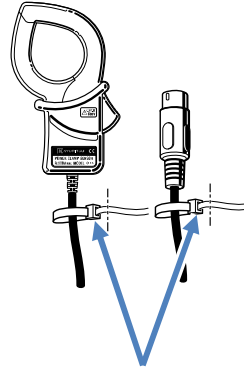

Attach Markers to the both ends of a Sensor.

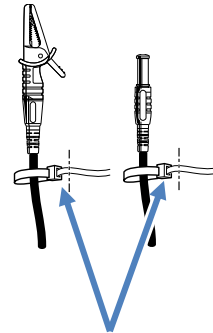

Attach Markers to the both ends of a Voltage test lead.

4.2 Power Supply

Battery

KEW6315 operates with either an AC power supply or batteries. Capable of performing measurements in the event of AC power interruption, power to the instrument is automatically restored by the batteries installed in the instrument. Size AA alkaline dry-cell batteries (LR6) or size AA Ni-MH batteries can both be used. To charge the rechargeable battery, use the charger which is manufactured by the same company as the batteries. KEW6315 cannot charge batteries.

* Size AA alkaline dry-cell batteries (LR6) are supplied as accessories.



DANGER

- Never open the Battery compartment cover during a measurement.
- Brand and type of the batteries to be used should be harmonized.
- Never touch the Power supply connector, although it is insulated, while the instrument is operating with batteries.



WARNING

- Ensure that the Power cord, Voltage test leads and Clamp sensor are removed from the instrument, and that the instrument is switched off when opening the Battery compartment cover for battery replacement.



CAUTION

- Never mix new and old batteries.
- Install batteries in correct polarity as marked inside the Battery compartment area.

Batteries are not installed in the instrument at the time of purchase. Please insert the supplied batteries before starting to use the instrument. Battery power is consumed even if the instrument is being off. Remove all the batteries if the instrument is to be stored and will not be in use for a long period. When the instrument is powered by an AC power supply, it doesn't operate with batteries.

If an AC supply is interrupted and the batteries have not been inserted, the instrument goes off and all data may be lost.

Battery Mark on the LCD/ Battery level

Power supply icon changes as follows, and the battery icon varies according to the battery condition.

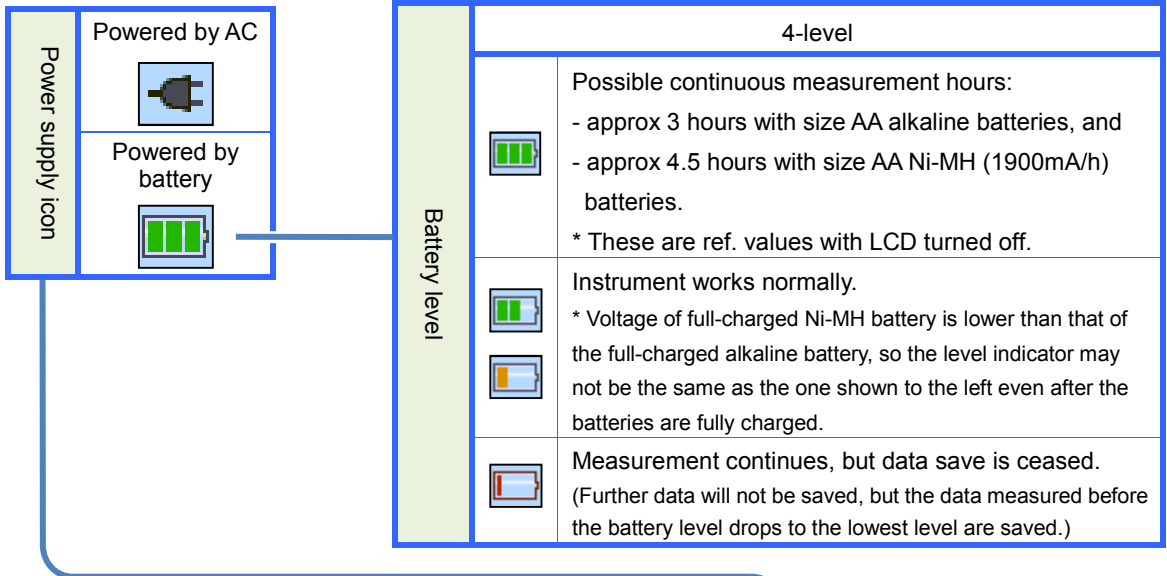

W/Wh				01/01/2014 5:54:20
	1ch	2ch	3ch	
V :	200.0	200.1	199.7	V
A :	450.1	448.9	299.6	A
P :	90.0	89.2	58.9	kW
Q :	2.8	-10.5	10.4	kvar
S :	90.0	89.8	59.8	kVA
PF :	0.999	-0.992	0.984	
P :	238.4 kW	f :	50.00	Hz
Q :	2.5 kvar			
S :	240.0 kVA	A4 :	448.9	A
PF :	0.993	An :	248.6	A
DC1 :	0 mV	DC2 :	0 mV	
				03:54 /30min
Wh	Zoom	Trend	Customize	

How to install batteries:

Follow the steps below and install batteries.

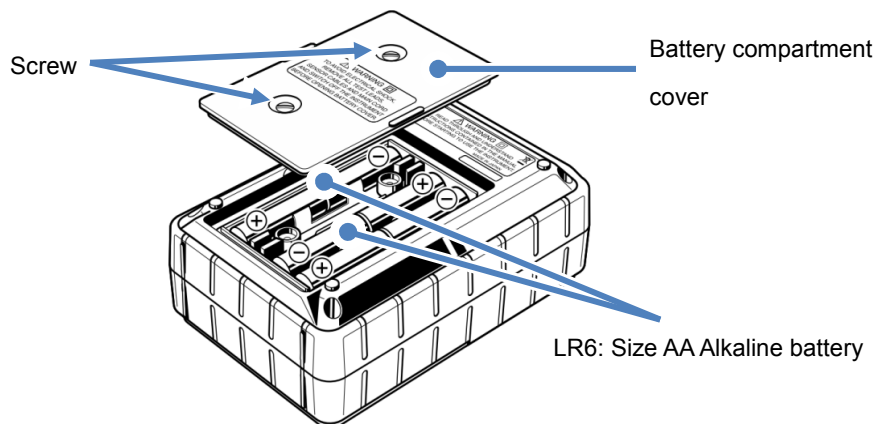

- 1 Disconnect the power cord, voltage test leads and clamp sensors from the instrument, and power off the instrument.
- 2 Loosen two Battery compartment cover-fixing screws and remove the Cover.
- 3 Take out all the batteries.
- 4 Insert six batteries (Size AA alkaline battery: LR6) in correct polarity.
- 5 Install the Battery compartment cover and fix it with two screws.

Power cord connection

! The following should be checked before the connection.

! DANGER

- Use only the Power cord supplied with this instrument.
- Connect the Power cord to a mains outlet. The mains supply voltage must not exceed AC240V.
(max rated voltage of supplied Power cord MODEL7169 : AC125V)

! WARNING

- Confirm that the instrument is powered off, and then connect the Power cord.
- Connect the Power cord to the instrument first. The cord should be firmly connected.
- Never attempt to make measurement if any abnormal conditions are noted, such as a broken cover and exposed metal parts.
- When the instrument is not in use, disconnect the Power cord from the outlet.
- When unplugging the cord from the mains socket outlet, do so by removing the plug first and not by pulling the cord.

Follow the procedure below, and connect the Power cord.

- 1 Confirm that the instrument is powered off.
- 2 Connect the Power cord to the Power connector on the instrument.
- 3 * Connect another end of the Power cord to the outlet.

* Getting KEW6315 started is possible 2 seconds after it is connected to a power source. The  Key does not work in this period.

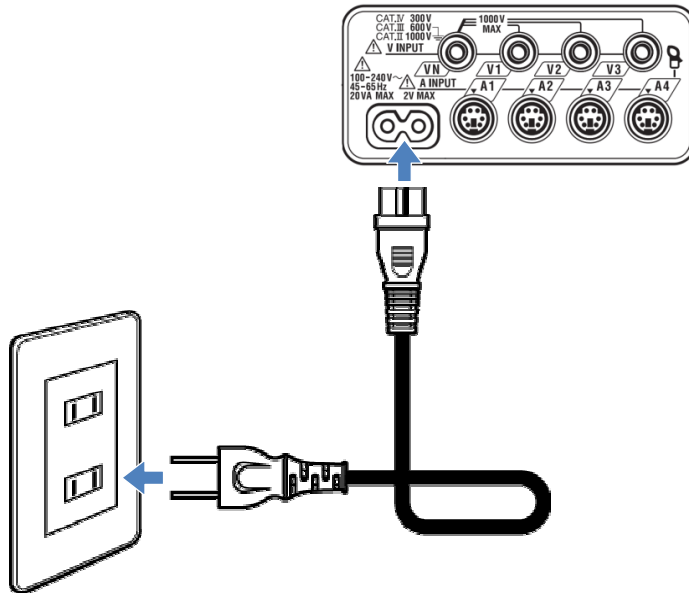

Power supply rating



Rating of power supply is as follows.

Rated supply voltage	100 to 240V AC ($\pm 10\%$)
Rated power supply frequency	45 to 65Hz
Max power consumption	7VA max

4.3 Placing / removing SD card

 Check the following points before using SD card.

CAUTION

- Follow the instructions described in “Inserting SD card” and insert the SD card to the slot with the top side turned up. If the card is inserted up-side-down, the SD card or the instrument may be damaged.
- While using an SD card, do not replace or remove the card. (The  symbol blinks while accessing SD card.) Otherwise, the saved data in the card may be lost or the instrument may be damaged.
- The indicator “” blinks during record. Do not remove the SD card. Otherwise, the saved data or the instrument may be damaged. Do not remove the card until the record ends and the pop-up message “Stop recording.” disappears.

Notes:

- Newly purchased SD cards must be formatted with KEW6315 before use. Data might not be successfully saved on SD cards that are formatted with a PC. For the details, please refer to “**Format**” (P.86) in this manual.
- If the SD card has been frequently used for a long period, the life of the flash memory may be expired and further data may not be saved on it. In such a case, please replace the card with a new one.
- The data in the SD card might be damaged or lost by accident or failure. It is recommended to backup the recorded data periodically. Kyoritsu will not be liable for any loss of data or any other damages or losses.

Inserting SD card:

- 1 Open the Connector cover.
- 2 Insert the SD card into the SD card slot with the topside turned up.
- 3 Then close the cover. Please use the instrument with the Connector cover closed unless it is not necessary.

Removing SD card:

- 1 Open the Connector cover.
- 2 Gently push the SD card towards inside, and then the card comes out.
- 3 Remove the card slowly.
- 4 Then close the cover. Please use the instrument with the Connector cover closed unless it is not necessary.

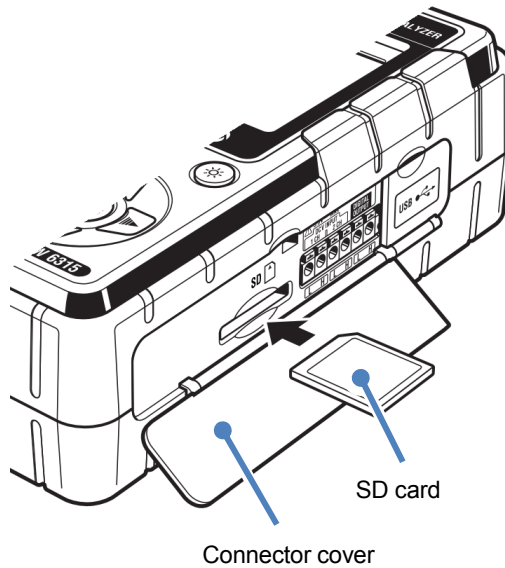

4.4 Voltage test leads and Clamp sensor connection

! Check the following before connecting the test leads and sensors.

! DANGER

- Use only the Voltage test leads supplied with this instrument.
- Use the dedicated Clamp sensors for this instrument, and confirm that the measurement current rating of the Clamp sensor is not exceeded.
- Do not connect all the Voltage test leads or Clamp sensors unless required for measuring the desired parameters.
- Connect the test leads and sensors to the instrument first, and only then connect them to the circuit under test.
- Never disconnect the Voltage test leads and sensors while the instrument is in use.

! WARNING

- Confirm that the instrument is powered off, and then connect the Power cord.
- Connect the Power cord to the instrument first. The cord should be firmly connected.
- Never attempt to make measurement if any abnormal conditions are noted, such as a broken Cover and exposed metal parts.

Follow the procedure below, and connect the Voltage test leads and Clamp sensors.

- 1 Confirm that the instrument is powered off.
- 2 Connect the appropriate Voltage test lead to the AC Voltage input terminal on the instrument.
- 3 Connect the appropriate Clamp sensor to the Current input terminal on the instrument.
Match the direction of the arrow mark indicated on the output terminal of the clamp sensor and the mark on the Current input terminal on the instrument.

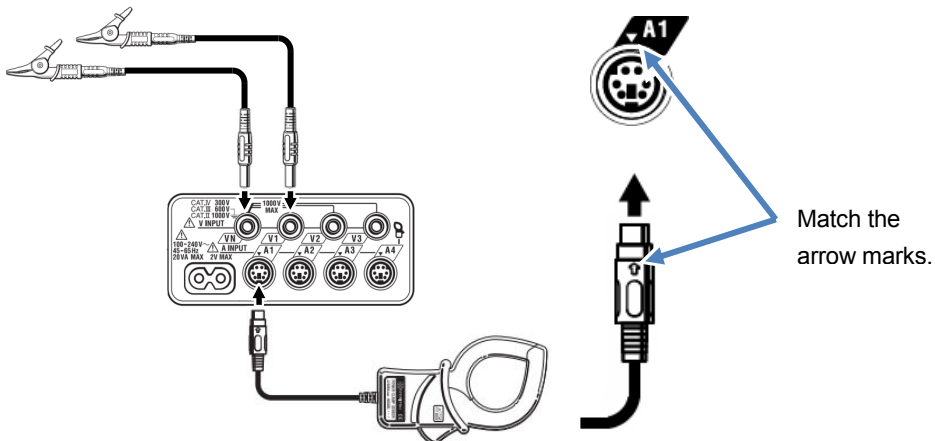

Number of Voltage test leads and Clamp sensors to be used will be different depending on the wiring configuration under test. For further details, refer to "**Wiring diagrams**" (P.50) in this manual.

4.5 Start KEW6315

Start-up Screen

Hold down the **POWER** key until the following screen is displayed on the LCD. To power off the instrument, hold down the **POWER** key at least 2 seconds.

- 1 Model name and software version will be displayed upon powering on the instrument. Stop using the instrument if it does not get started properly, and refer to **“Chap. 11 Troubleshooting” (P.157)** in this instruction manual.

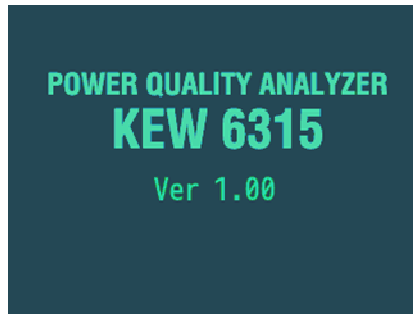

- 2 If this is not the first time starting the instrument, the screen displayed last from the previous operation will appear.

Cautionary message

If the connected Clamp sensors are not the same ones used during the previous test, the list of the connected sensors will be displayed for 5 sec; but the settings will not be updated automatically. Press the **SETUP** key and re-detect the sensors or modify the settings directly. KEW6315 retains and adopts the previous settings if no sensor is connected.

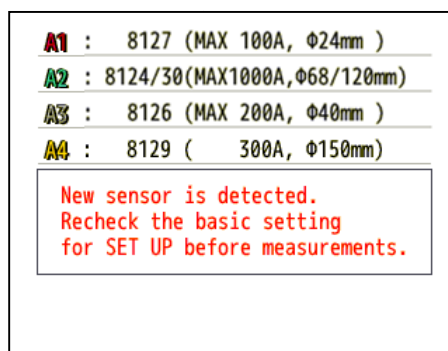

4.6 Recording procedures

Start of recording

Press the  Key.

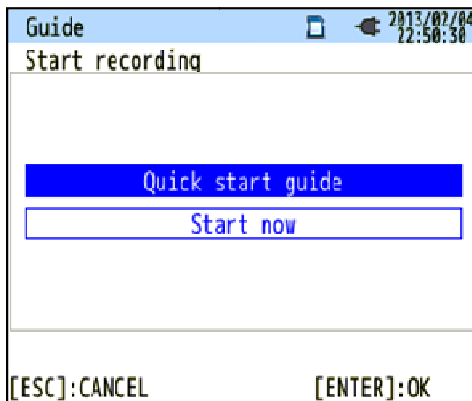

Choose either “Quick start guide” or “Start now” to start recording. One can do the simple and fast start-up by selecting “Quick start guide”. Only the settings of wiring and recording are included in the “Quick start guide”. Press the  key and adjust advanced settings if necessary. When the necessary settings are already done, or no change of settings is required, select “Start now” to start recording. Before starting measurement, ensure all safety and necessary preparations have been checked.



Move the blue highlight to “Quick start guide” or “Start now”.



Confirm.



Cancel.

End of recording

Press the  Key.

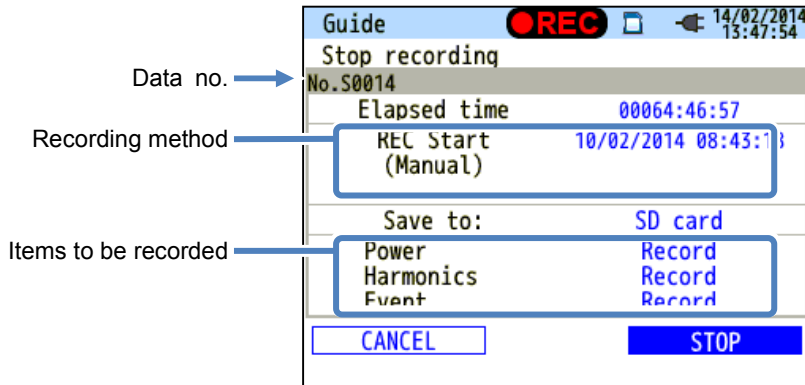

Check the information about recording, or stop the recording.

Items displayed on the LCD		
Data no.	Data no. of the recorded data. It is also used as a folder name at data saving.	
Elapsed time	The time that elapses while recording.	
Recording method	Manual	Show the "Recording start date and time".
	Constant rec.	Show the "Recording start/ end date and time".
	Time period rec.	Show the "Recording start date and time", "Recording Period" and "Recording Time".
Save to	Data location to save the data.	
Items recorded	Items being recorded.	



Move the blue highlight to "Cancel" or "Stop".  Confirm.  Cancel.

Start measurement with “Quick start guide”

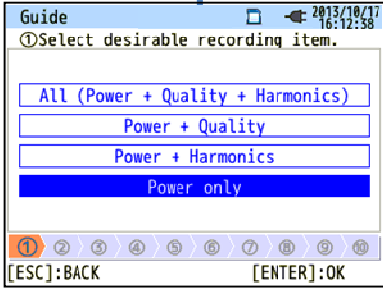

(1) Select the item you want to record.

* The number of selected items will have effect on file size and also on max recording time.

See P.37.

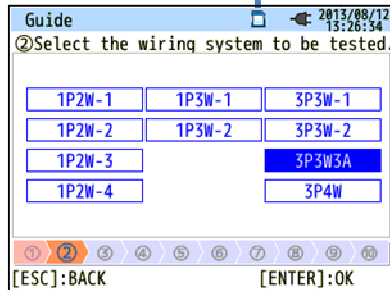

(2) Select the wiring system to be measured.

* Select a proper wiring system for accurate measurements.

See P.41.

(3) Connect to the circuit to be tested.

* Read and follow the safety precautions described in the instruction manual.

See P.27.

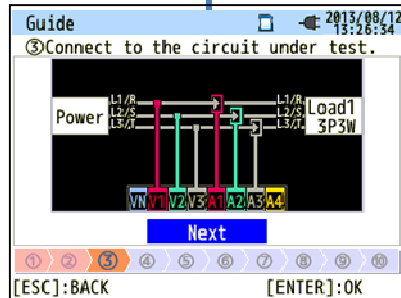

(4)(5) Check the Test environment.

* Self-diagnosis, wiring check and detection of connected sensors will be performed in this test.

* It is recommended to do this test for ensuring the testing conditions are correct. It takes about 10 seconds.

See P.42.

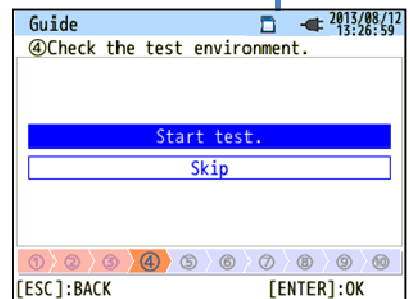

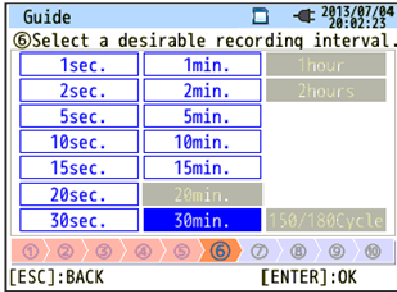

(6) Select a recording interval.

* Selecting a short interval gets the file size large. In this case, a long period recording cannot be performed.

See P.76.

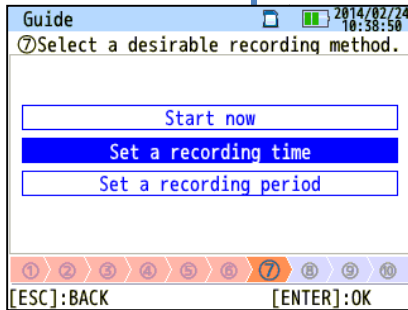

(7)(8)(9) Select a recording method.

See P.45.

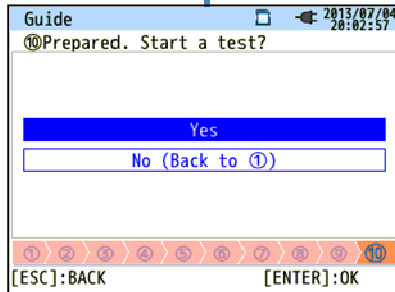

(10) Prepared. Recording will start.

The mark "REC" will appear on the screen when the recording starts, and the green LED (status indicator) lights up.

If you want to terminate the recording, press the "START/STOP" button and follow the instructions displayed on the screen.

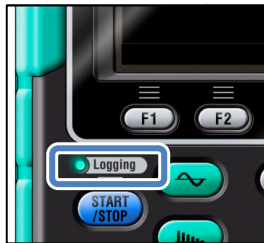
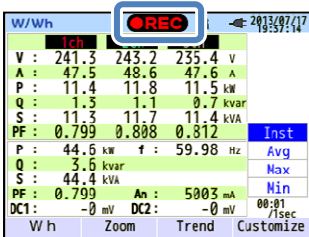

(2) Wiring system

Any of the following can be selected.

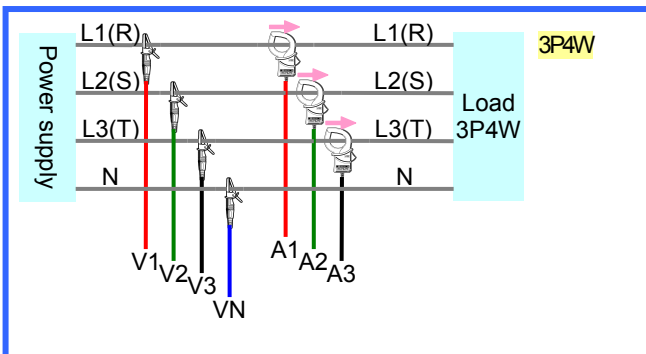
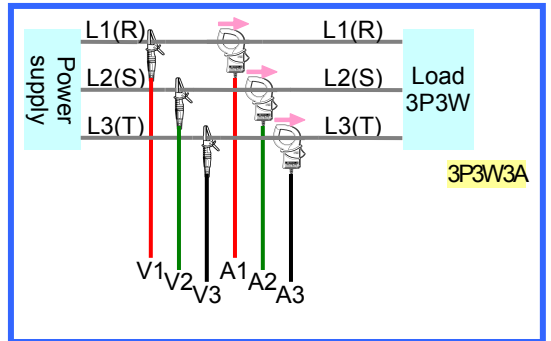
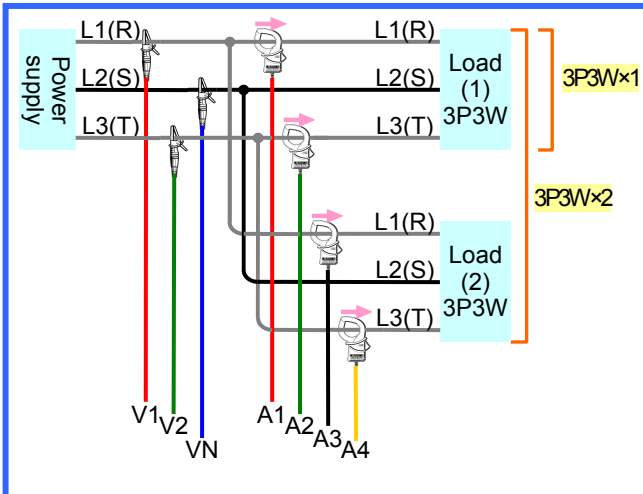
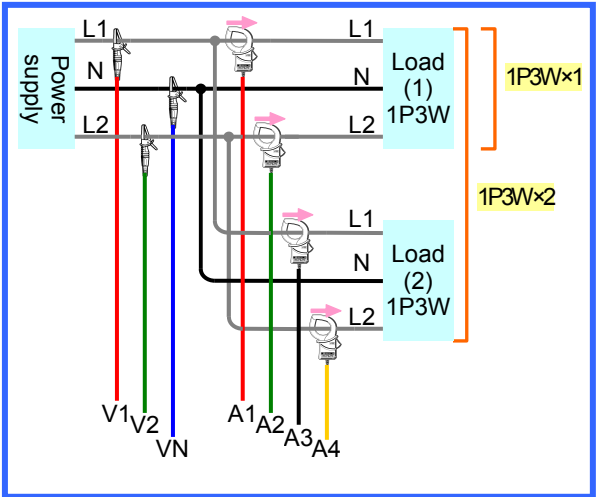
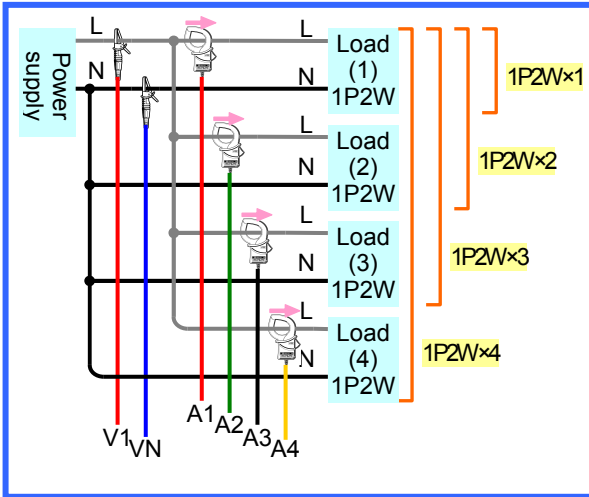

Orientation of Clamp sensor

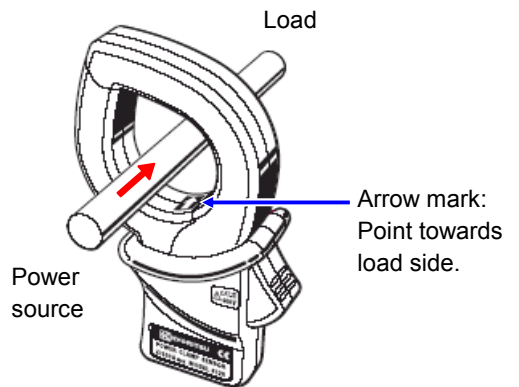

Reverse clamping switches the symbols (+/-) for active power (P).

(4)(5) Test Environment Check

Switching screens

Test environment check

Select "Start test" and press the "ENTER" button to start the test. The test result will be displayed on the screen.

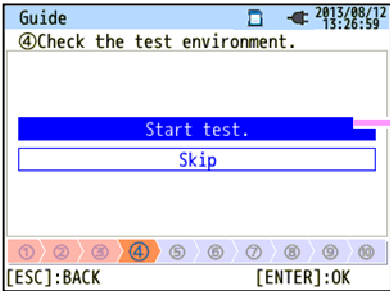

Wiring check

Test results of each item will be displayed.

* NG result may be given, even if the wiring is correct, at the measurement site under bad power factors.

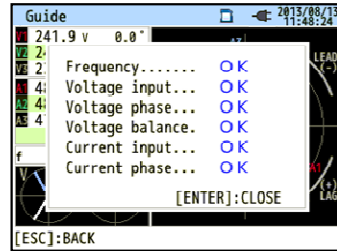

Select and press the "ENTER" on "OK"/"NG" to see the details.

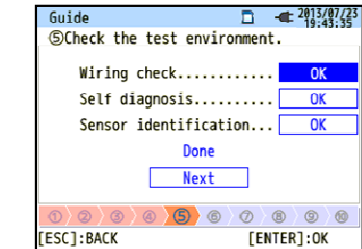

Self-diagnosis

Operating condition of the instrument system will be checked and the result will be displayed.

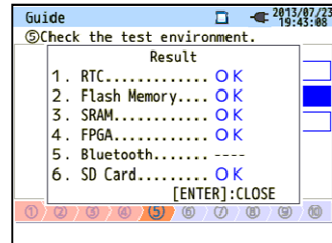

Sensor detection

The connected sensors are automatically detected and their max Ranges will be set.

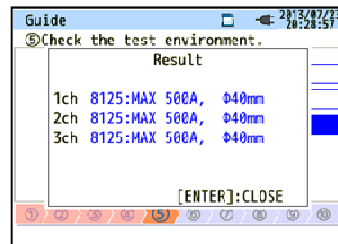

NG judgment

Wiring check

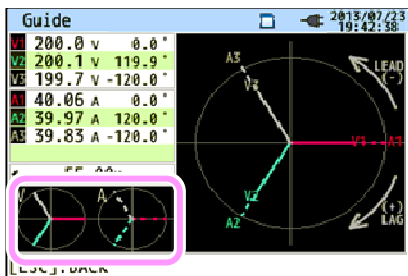

Close the result display. Then, the blinking vectors and the values of NG items will be displayed. If everything is OK, the ideal vector diagram will be displayed in the lower left corner.

Criteria of judgment and cause

Check	Criteria of Judgment	Causes
Frequency	Frequency of V1 is within 40 - 70Hz.	- Voltage clip is firmly connected to the DUT? - Measuring too high harmonic components?
AC Voltage input	AC voltage input is 10% or more of (Nominal voltage x VT).	- Voltage clip is firmly connected to the DUT? - Voltage test lead is firmly connected to the AC voltage input terminal on the instrument?
Voltage balance	AC voltage input is within $\pm 20\%$ of reference voltage (V1). * (not checked for single-phase wiring)	- Settings are matched with the wiring system under test? - Voltage clip is firmly connected to the DUT? - Voltage test lead is firmly connected to the AC voltage input terminal on the instrument?
Voltage phase	Phase of AC voltage input is within $\pm 10^\circ$ of reference value (proper vector).	- Voltage test leads are properly connected? (Connected to proper channels?)
Current input	Current input is 5% or more and 110% or less of (Current Range x CT).	- Clamp sensors are firmly connected to the Power input terminals on the instrument? - Setting for Current Range is appropriate for input levels?
Current phase	- Power factor (PF, absolute value) at each CH is 0.5 or more. - Active power (P) at each CH is positive value.	- Arrow mark on the Clamp sensor and the orientation of flowing current coincide with each other? (Power supply to Load) - Clamp sensors are connected properly?

Self-diagnosis

If "NG" judgment is given frequently, there might be something wrong with the instrument. Stop using the instrument and refer to "**Chap.11 Troubleshooting**" (P.157).

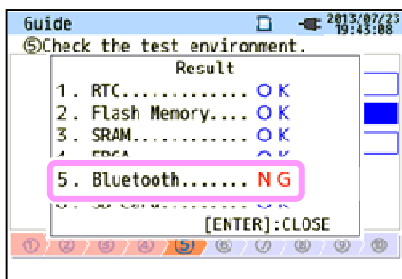

Sensor detection

If the detection result is NG, each sensor type will be displayed in red.

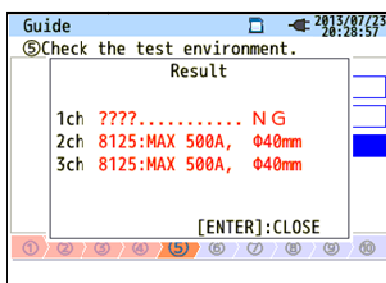
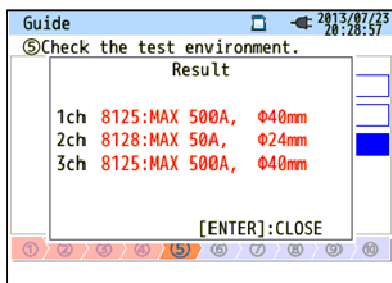

Criteria of judgment and cause

Check	Causes
Type of current sensor	- Types of the connected current sensors are harmonized? Types of the current sensors used for measurements should be the same.
??? (cause unknown)	- Current sensors are firmly connected to the instrument? - If any failures are in doubt: Exchange the connections of the sensors and test again. Connect the current sensor, for which "NG" is given, to the CH on which another sensor is properly detected. If the result "NG" is given for the same CH, a defect of the instrument is suspected. A defect of sensor is suspected if "NG" is given for the same sensor connected to another CH. Stop using the instrument and the sensor, if any defects are in doubt, and refer to " Chap. 11 Troubleshooting " (P.157) in this manual.

(8)(9) Setting for recording method

The following explains how to set recording start date and time.

(8) Specify the recording start date and time.

During the selected period, KEW6315 records data at the preset intervals.

Example: When the date & time are specified as above, the recording period will be as follows.

From 8:00 on August 2, 2013 to 18:00 on August 7, 2013,



(9) Specify the recording time period.

KEW6315 records data during the selected time period at the preset intervals, and repeats the recording process during the preset time span.

Example: When the time period is specified as above, the recording period is as follows.

- (i) 8:00 to 18:00 on August 1, 2013,
- (ii) 8:00 to 18:00 on August 2, 2013,
- (iii) 8:00 to 18:00 on August 3, 2013,
- (iv) 8:00 to 18:00 on August 4, 2013,
- (v) 8:00 to 18:00 on August 5, 2013,
- (vi) 8:00 to 18:00 on August 6, 2013,
- (vii) 8:00 to 18:00 on August 7, 2013, and
- (viii) 8:00 to 18:00 on August 8, 2013.

Switching of displayed parameters

Basically, the **Cursor** Key  is used for selecting an item, the **ENTER** Key  is for confirming the selection, and the **ESC** Key  is for canceling the alternation. Taking the procedures in "Quick Start Guide" as an example, Key operations are explained as follows.

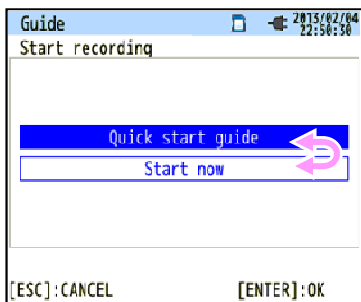

Press the **Cursor** Key to move the **blue highlight**, showing the item is being selected, over the items in blue letters. In the screen to the left is the Recording start screen. Press the **Cursor** Key and move the blue highlight on the desirable recording method, and press the **ENTER** Key to confirm the selection. To quit the start guide, press the **ESC** Key.

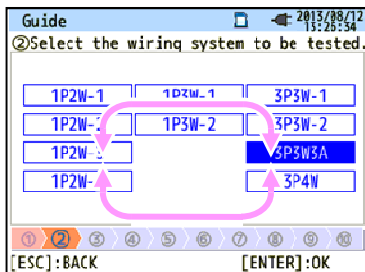

If the display of the **selectable items** is similar to the one shown to the left, then the up, down, right and left **Cursor** Keys can be used. Use the **Cursor** Keys to select the proper wiring system and press the **ENTER** Key to confirm the selection. To return to the previous screen and cancel the changes, press the **ESC** Key.

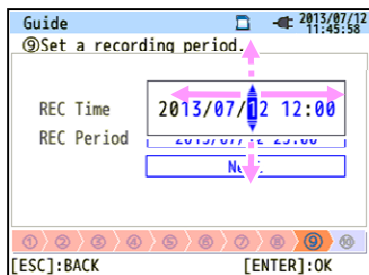

To alter the numbers such as **Date/ Time**, move the blue highlight over digits with the right and left **Cursor** Keys and alter the number with the up and down **Cursor** Keys. In the screen to the left, the tenth place of the day is being selected. The number can be increased or decreased by 1 with the up/ down **Cursor** Keys. Press the **ENTER** Key to confirm the selection, or press the **ESC** Key to return to the previous screen and cancel the changes.

CAUTION:

If "AUTO" is set for "A Range", either "Power + Harmonics" or "Power only" is selectable at step (1): *Select desirable recording item..* To record the items related to power quality, set it to any other proper current ranges other than "AUTO". Only the settings of wiring and recording are included in the "Quick start guide".

The following should be selected and entered before starting a record. Press the **SET UP** key to show the setting screen.

* Nominal voltage/ frequency, THD for power quality event and filter coefficient (ramp) for Flicker measurement. When the setting of "A Range" is set to other than "AUTO", the settings of "+ Clamp" will be automatically altered to "OFF".

5 Settings

5.1 List of setting items

Settings for measurement condition and data saving are necessary prior to making measurements. Press the **SETUP** Key to enter into the SET UP mode and do the necessary settings.

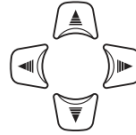

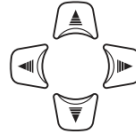
Settings consist of the following five categories. Use the  to move between the categories.

After making the necessary changes, switch screens and exit from the SET UP screen. Confirm that the  is displayed in the upper left of the LCD at this time. This means the changes are enabled. If powering off the instrument without switching screens, the changes you made will be cleared.

Basic Setting

Make settings for the items common to each measurement.

Measurement Setting

Make settings for each measurement mode.

Recording Setting

Make settings for recording.

Save Data

Edit the recorded data or alter the instrument setting.

Others

Configure the environmental setting.

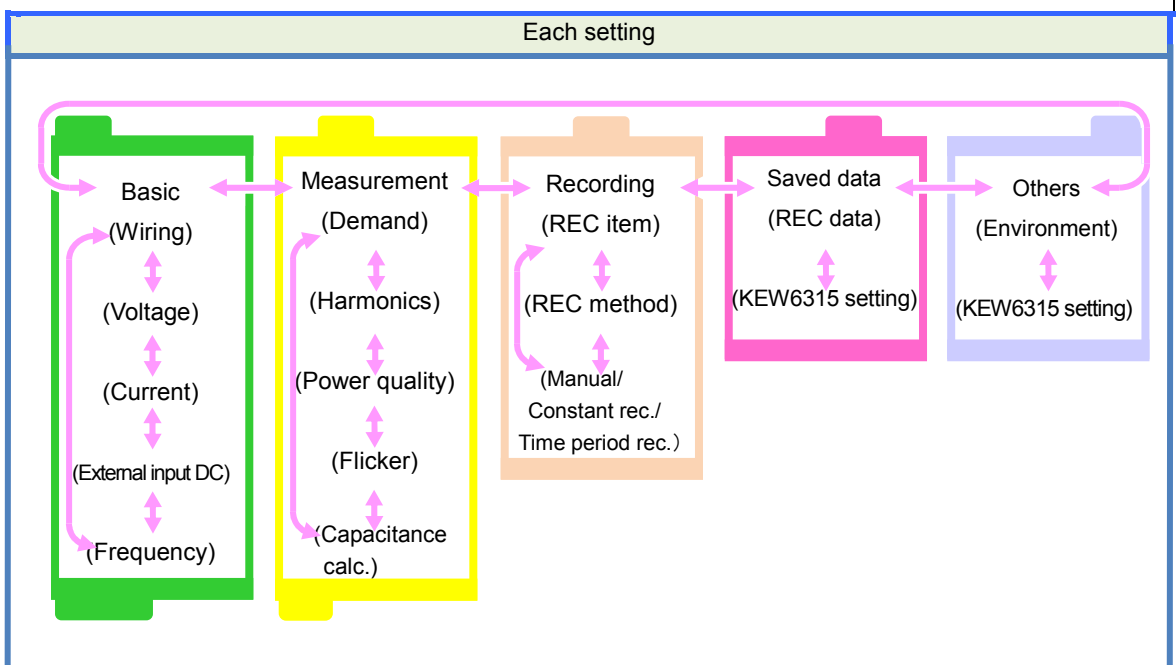

5.2 Basic setting

Press the **SETUP** Key. → Use the  Key to display the Basic setting screen.

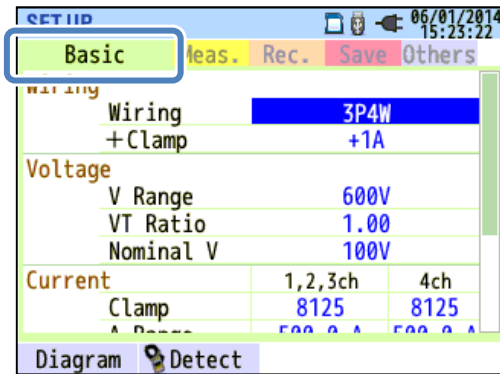

Settings of wiring system

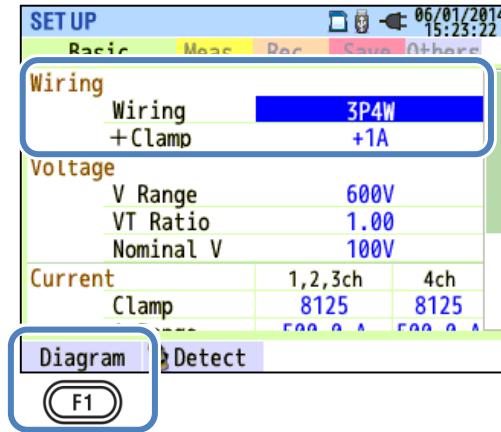

”Basic wiring”

Choose one according to the wiring system to be measured.

Selection		
(1) 1P2W×1	(5) 1P3W×1	(7) 3P3W×1
(2) 1P2W×2	(6) 1P3W×2	(8) 3P3W×2
(3) 1P2W×3		(9) 3P3W3A
(4) 1P2W×4		(10) 3P4W

* Current terminals that are not used in the selected wiring system can be used to measure rms currents and harmonics.

* Default setting is highlighted in gray.



Move the blue highlight to “Wiring”.



Show the pull-down menu.

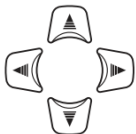

Select a proper wiring system.



Confirm.



Cancel.

“+ Clamp” : Optional clamp sensors



Move the blue highlight to “+ Clamp”.



Show the pull-down menu.



Select a proper clamp setting.



Confirm.



Cancel.

Wiring diagrams

When the blue highlight is located at "Wiring", you can check the wiring diagram of the selected wiring system with the **F1** key. The displayed diagram can be switched with **F1** or **F2** key. **ENTER** Confirm. **ESC** Cancel.

1P2W-1

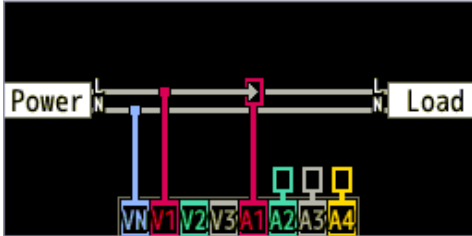

1P2W-2

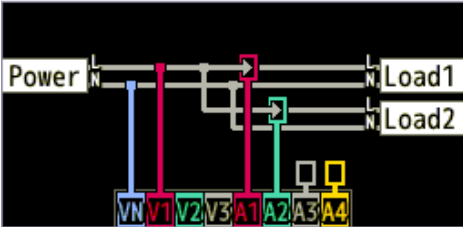

1P2W-3

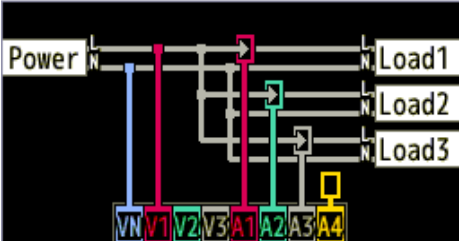

1P2W-4

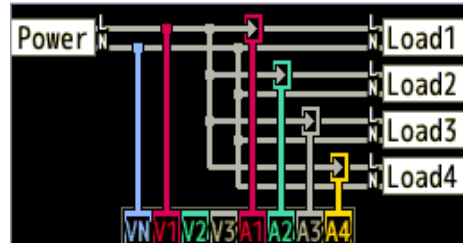

1P3W-1

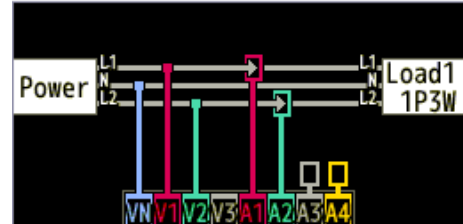

3P4W

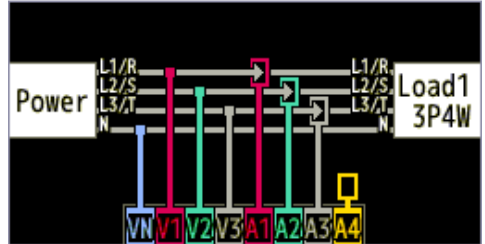

3P3W3A

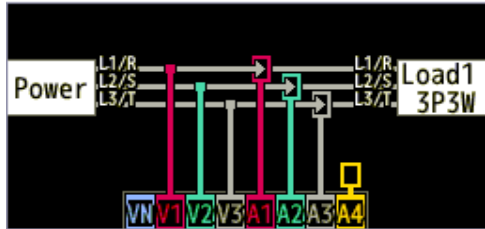

3P3W-2

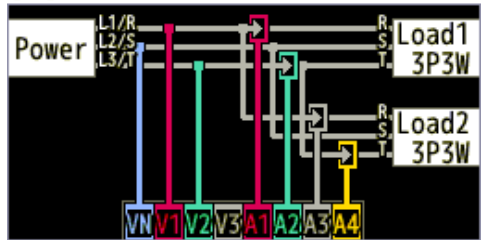

3P3W-1

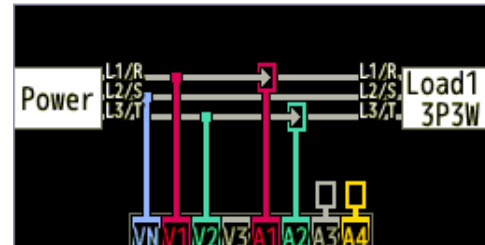

1P3W-2

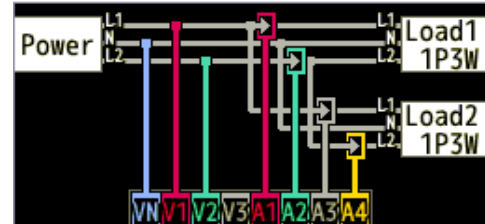

Wiring connection



Read the following precautions prior to wiring connection.

DANGER

- With attention to the measurement category to which the object under test belongs, do not make measurements on a circuit in which the electrical potential exceeds the following values.
 - * 300V AC for CAT. IV, 600V AC for CAT. III, 1000V AC for CAT. II
- Use the voltage test leads and clamp sensors dedicated for this instrument.
- Connect the clamp sensors, voltage test leads and power cord to the instrument first, and then connect them to the measured object or the power source.
- When the instrument and the test lead are combined and used together, whichever lower category either of them belongs to will be applied. Confirm that the measured voltage rating of the test lead is not exceeded.
- Do not connect voltage test leads or clamp sensors unless required for measuring the desired parameters.
- Clamp sensors should always be connected on the downstream side of a circuit breaker, which is safer than the upstream side.
- Do not open-circuit the secondary side of a supplementary CT while it is energized because of the high voltage generated at the secondary side terminals.
- Be careful to avoid short-circuiting the power line with the un-insulated part of the voltage test probes during the setting up of the instrument. Do not touch the tip metal part.
- Transformer jaw tips are designed in such a way to avoid short-circuiting. If the circuit under test has exposed conductive parts, extra care should be taken to minimize the possibility of shorting.
- Keep your fingers behind the barrier during a measurement.
Barrier: provides protection against electrical shock and ensuring the minimum required air and creepage distances.
- Never disconnect the voltage test leads from the connectors of the instrument during a measurement (while the instrument is energized).
- Do not touch two lines under test with the metal tips of the test leads.

WARNING

- To avoid possible electric shock and short-circuit, always turn off the line under test at wiring connection.
- Do not touch the un-insulated tip of voltage test leads.

! Clamp sensor direction for correct measurement:

- Confirm that the wiring system selected with the instrument and of the measured line are harmonized.
- Ensure that the arrow mark on the clamp sensor points towards to load side.

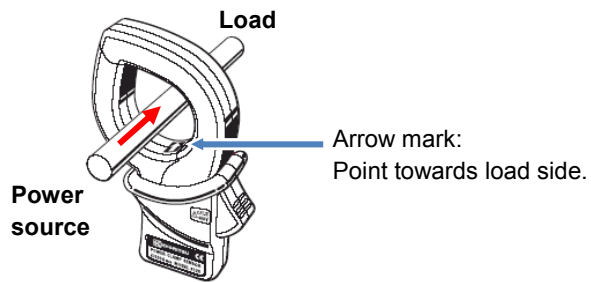

* Reverse clamping switches the symbols (+/-) for active power (P).

Settings of voltage measurement

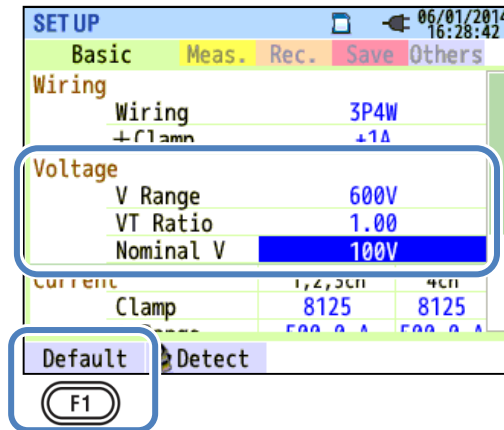

“Voltage range”

Choose a desired voltage range.

* For measurements according to IEC61000-4-30 Class S, set the range to “600V”.

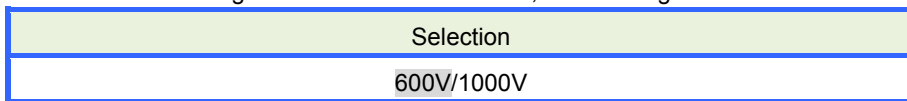

* Default setting is highlighted in gray.



Move the blue highlight to “V Range”.



Show the pull-down menu.



Select a proper voltage range.



Confirm.



Cancel.

”VT Ratio”

Set the proper VT ratio when VTs (transformer) are installed in the measured system. The selected VT ratio will be reflected to all the values measured during any voltage measurements.

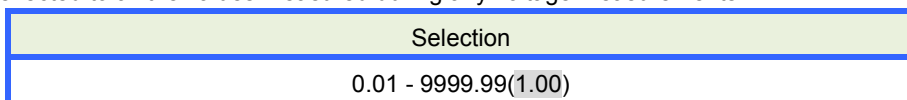

* Default value is highlighted in gray.



Move the blue highlight to “VT Ratio”.



Show the value entry window.*

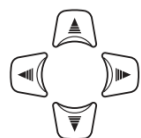

Set the VT Ratio.



Confirm.



Cancel.

* A pop-up appears and shows the effective range.

VT/CT*

* This setting belongs to Current measurement setting.

DANGER

- With attention to the measurement category to which the object under test belongs, do not make measurements on a circuit in which the electrical potential exceeds the following values.
* 300V AC for CAT. IV, 600V AC for CAT. III, 1000V AC for CAT. II
- Connect the Power cord to an outlet. Never connect it to the outlet of AC240V or higher.
- This instrument must be used on the secondary side of VT (transformer) and CT (current transformer).
- Do not open-circuit the secondary side of the supplementary CT while it is energized because of the high voltage generated at the secondary side terminals.

CAUTION

- When a VT or CT is used, the measurement accuracy is not guaranteed due to several factors namely phase characteristics and VT/CT accuracies.

The use of supplementary VT/CT's may be required if the voltage/current values of the circuit under test fall outside the instrument measuring range. In this case the value at the primary side of circuit can be obtained directly by measuring the secondary side with appropriate an VT or CT installed in the line under test as follows.

< Example of single-phase 2-wire (1-system) "1P2W x 1" >

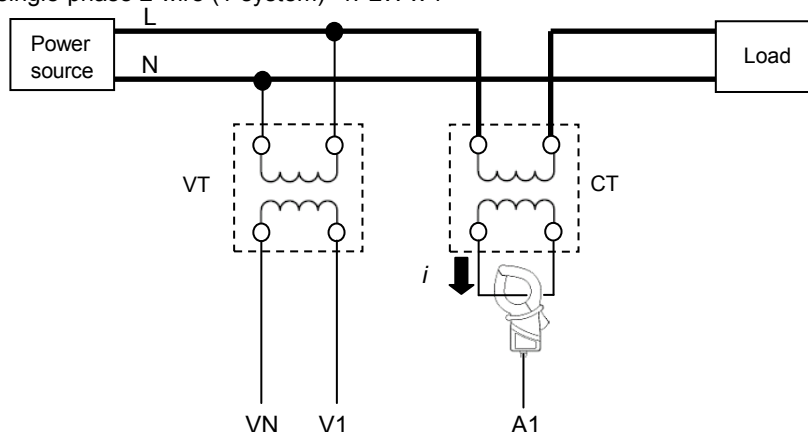

When rating of the secondary side of CT is 5A, use of Clamp sensor 8128 (50A type) and testing at 5A Range is recommended.

In this case, set the actual ratio of VT and CT to be used.

”Nominal voltage”

Set the nominal voltage values applied from the measured object.

Selection
50V - 600V(100V)

* Default value is highlighted in gray.



Move the blue highlight to “Nominal V”.



Show the value entry window.*



* A pop-up appears and show the effective range.

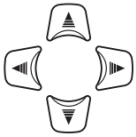

Enter the nominal voltage value.



Confirm.



Cancel.

Default values

When the blue highlight is located at “Nominal V”, you can check a list of the popular values

with the **F1** key.

Selection
100V/ 101V/ 110V/ 120V/ 200V/ 202V/ 208V/ 220V/ 230V/ 240V/ 277V/ 346V/ 380V/ 400V/ 415V/ 480V/ 600V

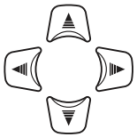

Choose the appropriate voltage.



Confirm.



Cancel.

Settings of current measurement

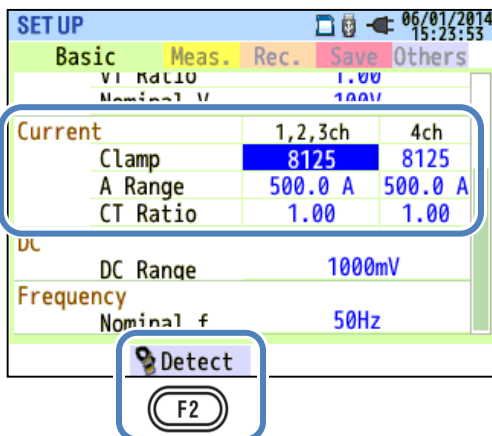

“Clamp” : Clamp sensors for current measurement

Select the model names of the connected sensors. If an optional sensor is used and set for “+Clamp”, an exceptional sensor can be set for 4ch. The rated current and the max conductor size are displayed in a pop-up while opening the list of sensor model names.

Selection	
8128:5/ 50A/ AUTO	} Clamp sensors for power measurement
8127:10/ 100A/ AUTO	
8126:20/ 200A/ AUTO	
8125:50/ 500A/ AUTO	
8124/ 8130:100/ 1000A/ AUTO	} Clamp sensors for leakage current measurement
8129:300/ 1000/ 3000A	
8141: }	
8142: } 500mA/ AUTO	
8143: }	
8146: }	
8147: } 1/ 10A/ AUTO	
8148: }	

* Default setting is highlighted in gray.

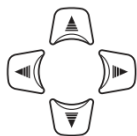

Move the blue highlight to “Clamp”.



Show the pull-down menu.



Select the model name of the sensor.



Confirm.



Cancel.

"Current range"

Choose a desired current range. While "Record" is set at the "Recording Tab" to record the power quality events, "AUTO"* is not selectable. To enable auto-ranging at current range, select "Do not record" for "Event" in the REC Item. Please refer to "**VT/ CT**" (P. 54) in this manual for the detailed settings of power quality events.

* Measurements according to IEC61000-4-30 Class S cannot be performed while "AUTO" is selected.

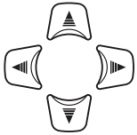

Move the blue highlight to "**A Range**". →



Show the pull-down menu. →



Select a desired range. →



Confirm.



Cancel.

"CT Ratio"

Set the proper CT ratio when CTs (current transformer) are installed in the measured system. The selected CT ratio will be reflected to all the values measured during any current measurements. The details about CT are described in "**VT/CT**" (P.54).

Selection
0.01 - 9999.99(1.00)

* Default value is highlighted in gray.

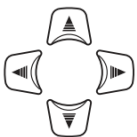

Move the blue highlight to "**CT Ratio**". →



Show the value entry window.* →

* A pop-up appears and show the effective range.

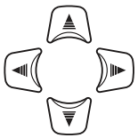

Set the CT Ratio. →



Confirm.



Cancel.

Sensor detection

Pressing the **F2** key detects and displays the model names of the connected sensors automatically.

However, if the connected sensors are not the ones that should be connected for the selected wiring system, or sensor detection fails, an error message will appear and the values entered at "Clamp", "A Range" and "CT Ratio" will be cleared. The details about "Sensor detection" are described in "**Sensor detection**" (P.44).

Settings of External input terminal/ reference frequency

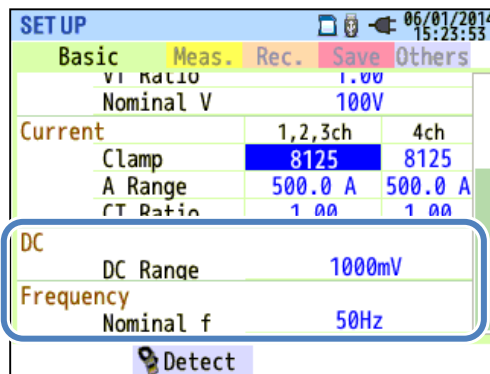

”DC Range”

Select a proper DC range according to the incoming DC voltage signals.

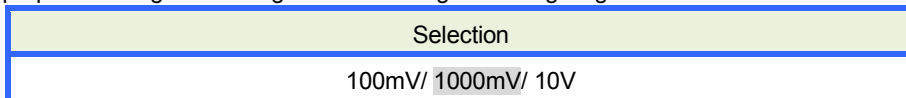

* Default setting is highlighted in gray.



Move the blue highlight to “DC Range”.



Show the pull-down menu.



Select a proper range.



Confirm.

ESC Cancel.

”Frequency”

Choose the nominal frequency of the system to be measured. If it is difficult to specify the voltage frequency, for example, in the event of power interruption, KEW6315 performs measurements based on the preset nominal frequency.

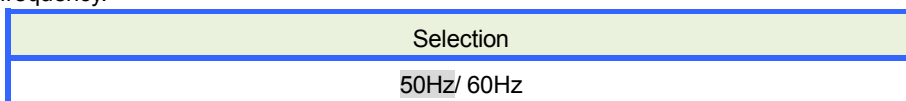

* Default setting is highlighted in gray.



Move the blue highlight to “Nominal f”.



Show the pull-down menu.



Choose the frequency.



Confirm.

ESC Cancel.

5.3 Measurement setting

Press the **SETUP** Key. →  Change the tabs to **"Measurement"**.

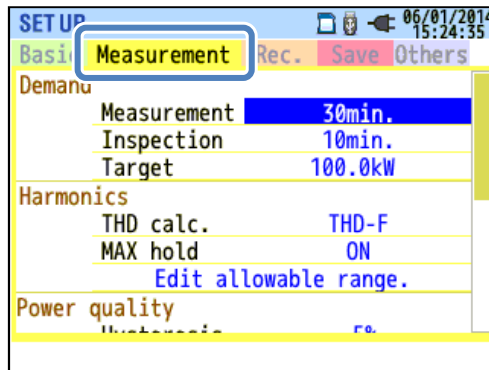

Settings of demand measurement

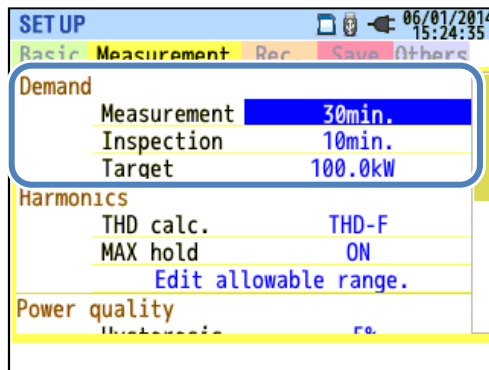

"Measurement cycle"

Disable the demand measurement or set the demand measurement cycle in the preset recording period. When a demand measurement start, the measured demand values will be recorded at the selected measurement cycle. The cycle time should be selected from the following.

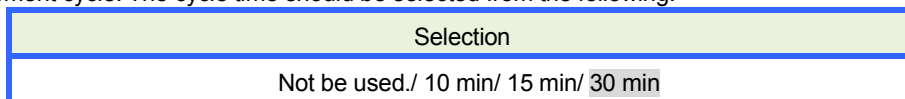

* Default setting is highlighted in gray.

The selected demand measurement cycle has an influence on the selection of the measurement intervals. Since the measurement interval cannot be set to a longer time than the demand interval, the preset measurement interval may be changed automatically according to the selected demand measurement cycle. Selectable measurement intervals: 1sec/ 2sec/ 5sec/ 10sec/ 15sec/ 20sec/ 30sec/ 1 min/ 2 min/ 5 min/ 10 min/ 15 min/ 30 min.



Move the blue highlight to **"Measurement"**. →  Show the pull-down menu. →



Select a desired demand cycle. →  Confirm.  Cancel.

”Target value”

Set the demand target value.

Selection
0.001mW - 999.9TW(100.0kW)

* Default setting is highlighted in gray.



Move the blue highlight to “Target”.



Show the value entry window.*

* A pop-up appears and show the effective range.

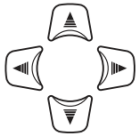

Enter the desired target value.



Confirm.



Cancel.

Either active or apparent power can be set as a demand target value. Pressing the **F1** “VA”/“W”

key while opening the value entry window can switch active and apparent power. Move the blue highlight with

the keys to the unit and alter the unit with keys. Moving the decimal point is possible by

pressing **F2** or **F3**.

* Unit for apparent power: mVA, _VA, kVA, MVA, GVA, TVA / for active power: mW, _W, kW, MW, GW, TW

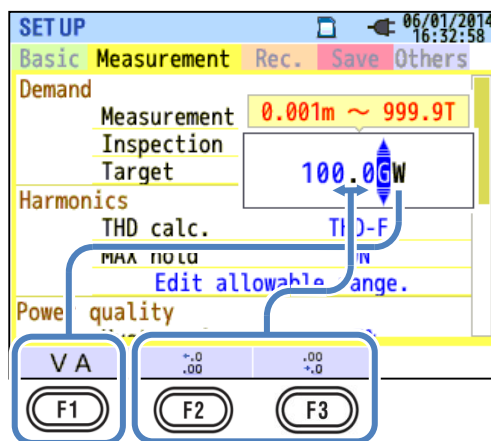

"Inspection cycle"

The buzzer sounds when the predicted value exceeds the target value within the selected inspection cycle. The inspection cycle should be shorter than the demand measurement cycle. The relations between the measurement and inspection cycles are as follows.

Measurement cycle	Inspection cycle
10 min/ 15 min	1 min/ 2 min/ 5 min
30 min	1 min/ 2 min/ 5 min/ 10 min/ 15 min

* Default value is highlighted in gray.



Move the blue highlight to "Inspection".



Show the value entry window.*



Select a desirable time.



Confirm.



Cancel.

* A pop-up appears and show the effective range.

Outline of demand measurement concept

In such a contract the electricity tariff rates (i.e. for kWhr units) are based upon the consumer's maximum power demand. The maximum demand is the maximum of average powers recorded over a 30min interval. Assuming the max target demand to be 500kW, the average power during Measurement cycle 1 is fine, but the power consumption for the first 15 min of Measurement cycle 2 is 600kW. In such a case, the average power during Measurement cycle can be maintained at 500kW (same as Measurement cycle 1) by reducing the power of the last 15 min to 400kW. If the power consumption during the first half of cycle 2 is 1000kW and the last 15min is 0kW, the average power is the same: 500kW. While "Inspection cycle" is set to "15 min", the buzzer sounds after 15 min at the start of Measurement cycle 2.

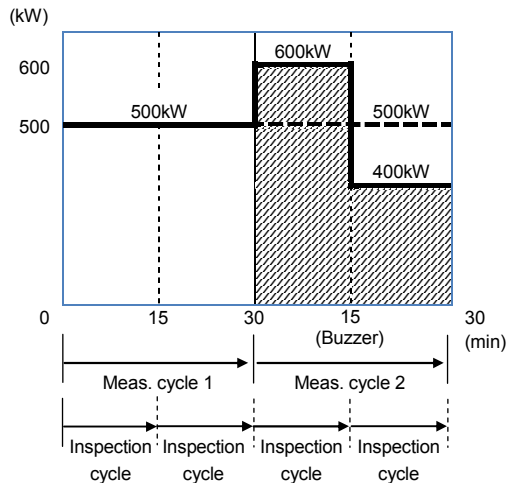

Settings for Harmonic analysis

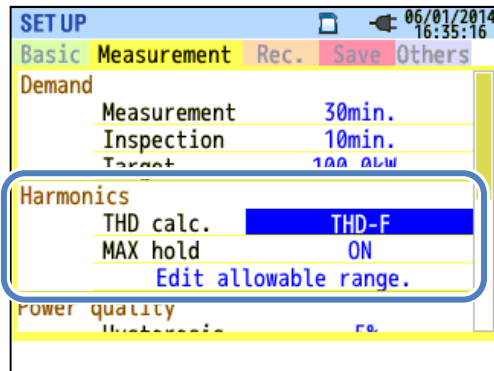

“THD calculation”

THD stands for “Total Harmonic Distortion”. Select “THD-F” to calculate the total harmonics distortion based on the basic wave and “THD-R” to do the calculation based on all rms values.

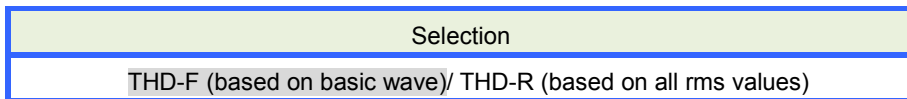

* Default setting is highlighted in gray.



Move the blue highlight to “**THD calc.**”.



Show the pull-down menu.



Select the calculation method.



Confirm.



Cancel.

”MAX hold”

Turn on the MAX hold to show the mark indicates the max rate of content on a harmonics graph.

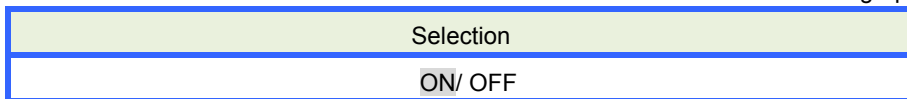

* Default setting is highlighted in gray.



Move the blue highlight to “**MAX hold**”.



Show the pull-down menu.



Turn on/ off.



Confirm.



Cancel.

”Edit allowable range”

Set the EMC allowable range (rate of content) for harmonics per order. The edited ranges are displayed as bar graph on the graph of harmonics.

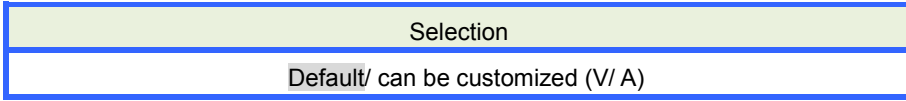

* Default setting is highlighted in gray.



Move the blue highlight to “**Edit allowable range**”.



Show the list of the ranges.

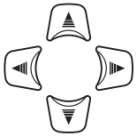

Select any desired harmonic order.



Show the value entry window.*

* A pop-up appears and show the effective range.

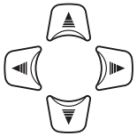

Set the allowable values.



Confirm.



Cancel.

The values in each box by default are complied with the international EMC standard IEC61000-4-7:

Industrial environment Class 3. Press the **F3** key (Default) to restore the edited values to default.

Press the **F2** key (A/V [%]) to switch current and voltage. The **F1** key is to return to the Measurement setting screen.

1:	2:	3:	4:	5:	6:	7:	8:	9:	10:
100.0	5.0	6.0	1.5	8.0	1.0	7.0	1.0	2.5	1.0
11:	12:	13:	14:	15:	16:	17:	18:	19:	20:
5.0	1.0	4.5	1.0	2.0	1.0	4.0	1.0	3.5	1.0
21:	22:	23:	24:	25:	26:	27:	28:	29:	30:
1.8	1.0	2.8	1.0	2.6	1.0	1.0	1.0	2.1	1.0
31:	32:	33:	34:	35:	36:	37:	38:	39:	40:
2.0	1.0	1.0	1.0	1.7	1.0	1.6	1.0	1.0	1.0
41:	42:	43:	44:	45:	46:	47:	48:	49:	50:
1.7	1.0	1.0	1.0	1.0	1.0	1.0	1.0	1.1	1.0

Threshold setting for Power quality (Event)

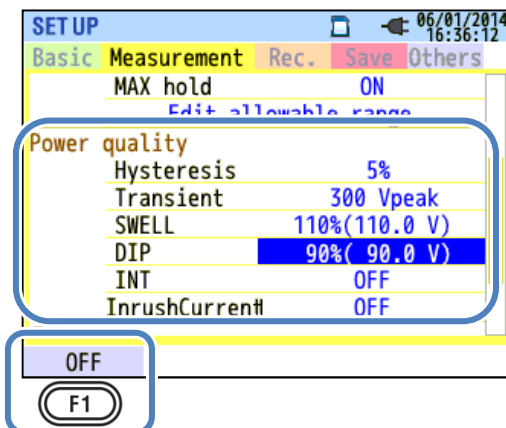

Press the **F1** (OFF/ ON) to disable or enable the “threshold value” entry. If “OFF” is selected, the item will not be recorded even the threshold value is set for it. The threshold value used during the previous measurement is displayed by pressing the **F1** (ON) key.

Caution:

Threshold values for “Swell”, “Dip” and “INT” are the percentage of the nominal voltage. So when the nominal voltage is changed, threshold voltage will be altered accordingly. For “Transient”, if the nominal voltage is changed, the initial value will be automatically set to “300%”, which is three times the new nominal voltage (peak voltage). The threshold value for “Inrush current” is the percentage of the Current Range, therefore, the value will be altered if the setting of the current range is changed.

”Hysteresis”

Set a desired hysteresis in percentage to disable the event detection for the specific area. Setting a proper hysteresis will be helpful to prevent unnecessary detections of events which are caused by voltage or current fluctuations around the threshold values.

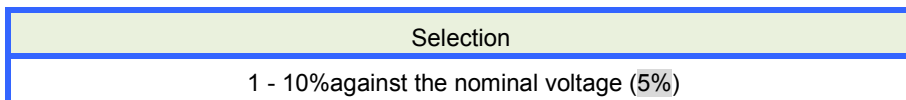

* Default value is highlighted in gray.



Move the blue highlight to “Hysteresis”.



Show the value entry window.*

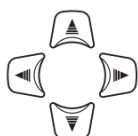

Set the hysteresis [%].



Confirm.



Cancel.

* A pop-up appears and show the effective range.

“Transient”: Over-voltage (Impulse)

Set an instantaneous voltage value as a threshold for the transient event. The following selection range varies depending on the selected VT ratio.

Selection
±50 to ±2200Vpeak against the nominal voltage (300%)

* Default setting is highlighted in gray.



Move the blue highlight to “**Transient**”.



Show the value entry window.*



* A pop-up appears and show the effective range.

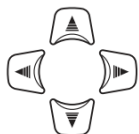

Set the voltage value.



Confirm.



Cancel.

Example of Transient detection:

The details are described in “*Displaying recorded events*” (P. 116).

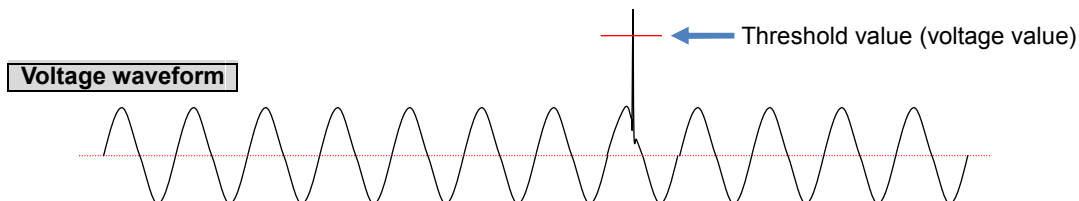

“SWELL”: Instantaneous voltage rise

Set the threshold value (rms voltage in one cycle) for swell in percentage of the nominal voltage. The following selection range varies depending on the selected VT ratio. The preset hysteresis has an effect on this threshold value.

Selection
100 - 200% against the nominal voltage (110%)

* Default setting is highlighted in gray.



Move the blue highlight to “SWELL”.



Show the value entry window.*

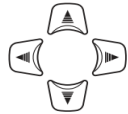

* A pop-up appears and show the effective range.

Set the percentages against the nominal voltage.

“Inrush Current”: Instantaneous current rise

Set the threshold value (rms current in one cycle) for inrush current in percentage of the max value of the Current range. The following selection range varies depending on the selected CT ratio. The preset hysteresis has an effect on this threshold value.

Selection
0 - 110% against the nominal voltage (100%)

* Default setting is highlighted in gray.



Move the blue highlight to “InrushCurrent”.



Show the value entry window.*

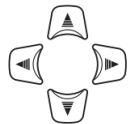

* A pop-up appears and show the effective range.

Set the percentages against the nominal voltage.

Example of Swell/ Inrush current detection:

The details are described in “*Displaying recorded events*” (P. 116).

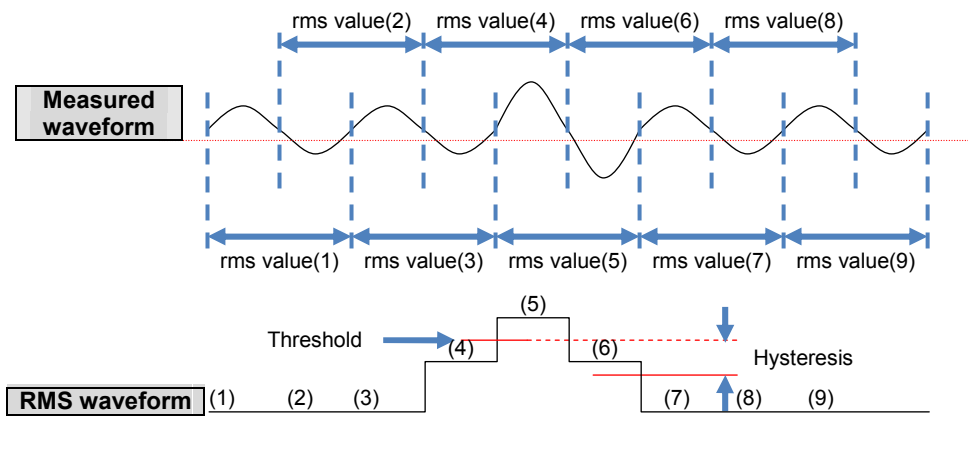

“DIP”: Instantaneous voltage drop

Set the threshold value (rms voltage in one cycle) for dip in percentage of the nominal voltage. The following selection range varies depending on the selected VT ratio. The preset hysteresis has an effect on this threshold value.

Selection
0 - 100% against the nominal voltage (90%)

* Default setting is highlighted in gray.



Move the blue highlight to “DIP”. →



Show the value entry window.* →

* A pop-up appears and show the effective range.

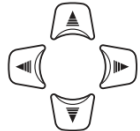

Set the percentages against the nominal voltage.

“INT”: A short period of power interruption

Set the threshold value (rms voltage in one cycle) for INT in percentage of the nominal voltage. The following selection range varies depending the preset VT ratio. The preset hysteresis has an effect on this threshold value. If rms voltages, 10V or less, are used for event detections, ensure that the Int event detection is enabled. Otherwise, events will not be detected properly.

Selection
0 - 100% against the nominal voltage (10%)

* Default setting is highlighted in gray.



Move the blue highlight to “INT”. →



Show the value entry window.* →

* A pop-up appears and shows the effective range.

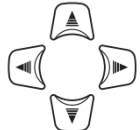

Set the percentages against the nominal voltage.

Example of Dip/ Int detection:

The details are described in “*Displaying recorded events*” (P. 116).

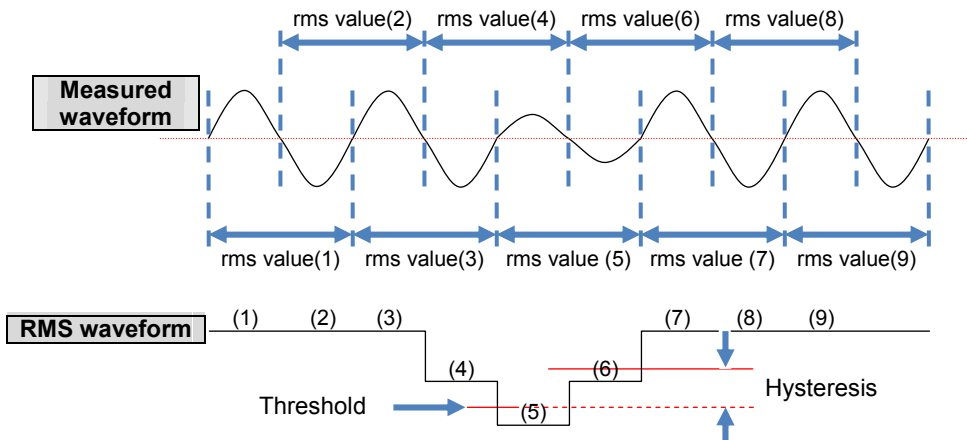

Filter setting for Flicker measurement

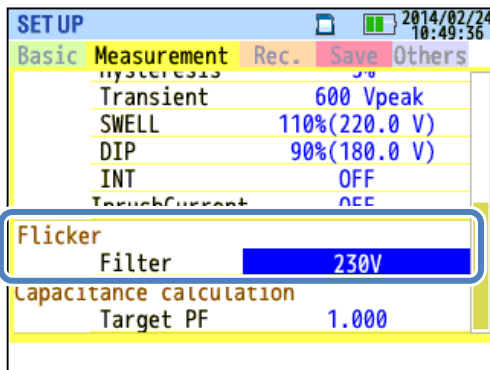

“Filter coefficient”

Set a proper filter coefficient according to the nominal voltage for accurate flicker measurements. Select the values of nominal voltage, nominal frequency and filter coefficient values appropriate to the actual measured object. If possible, harmonize the filter coefficient and the nominal voltage.

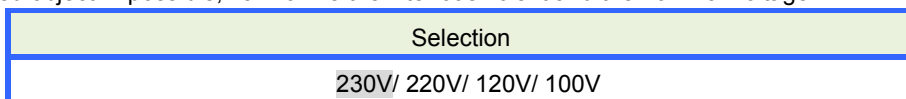

* Default setting is highlighted in gray.



Move the blue highlight to “Filter”.



Show the pull-down menu.



Select proper Filter coefficient.



Confirm.



Cancel.

Target power factor for Capacitance calculation

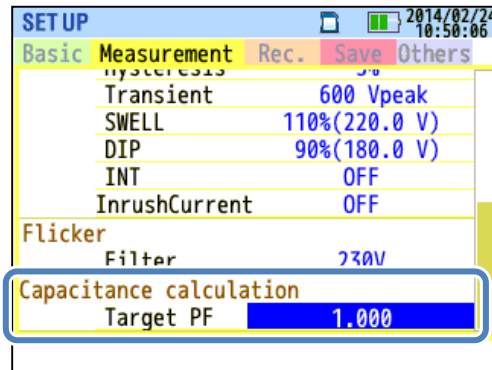

“Target power factor”

Set a target power factor for capacitance calculation. The power factor gets influenced badly if inductive loads, such as motors, are connected to the power supply because current phases lag behind the voltage phases in this case. Usually, phase advanced capacitors are installed in high-voltage-receiving installations, to reduce such influences. Improving the power factor may cut down electricity tariffs if the customer is on low-, high- or industrial power construction.

Selection
0.5 – 1 (1.000)

* Default setting is highlighted in gray.



Move the blue highlight to “Target PF”.



Show the value entry window.*

* A pop-up appears and show the effective range.

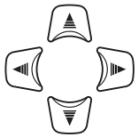

Select a desired target PF.

5.4 Recording setting

Press the **SETUP** Key. →  Change the tabs to **Recording**.

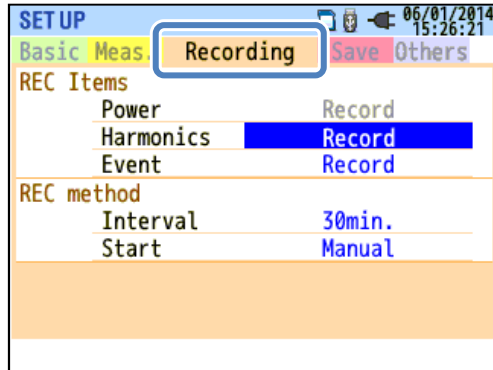

Settings for recording items

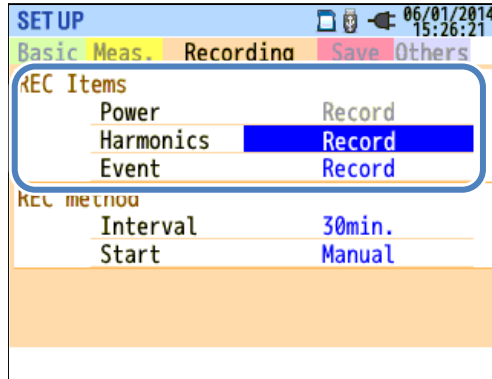

The possible recording time on SD cards or the internal memory varies depending on the number of the recorded items and the preset intervals. Select “Do not record” for the items which are not necessary to be recorded to secure a longer recording time. The details are described in **“Possible recording time”**(P. 76).

“Power”

The blue highlight cannot locate on this area. This is just to make sure all the items related to electric power are always recorded.

“Harmonics”

Select “Record” or “Do not record” the harmonics of voltage, current and power.

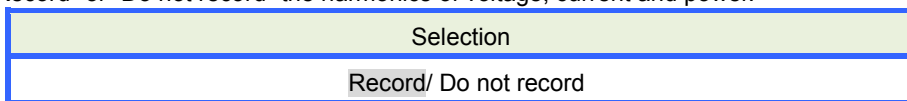

* Default setting is highlighted in gray.

“Event”

Select “Record” or “Do not record” the detailed data when power quality events occur. The “Do not record” is not selectable when “AUTO”* is set for “A Range”. To select “Record”, set it to any other proper current ranges other than “AUTO”.

* Measurements complied with IEC61000-4-30 Class S cannot be performed with “AUTO” setting.

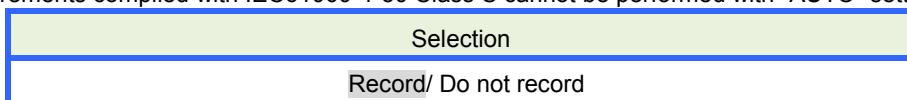

* Default setting is highlighted in gray.



Move the blue highlight to “**Harmonics**”/ “**Event**”. → Show the pull-down menu. →



Select “Record” or “Do not record”. → Confirm. Cancel.

Saved items

The following data measured on each CH will be saved according to the selected recording method. Saved items are depending on the selected recording method and wiring system.

REC file	REC item	Meas./ Rec. setting		
		Power	+Harmonics	+Event
Power measurement	RMS voltage (line/ phase)			
	RMS current			
	Active power			
	Reactive power			
	Apparent power			
	Power factor			
	Frequency			
	Neutral current(3P4W)			
	V/ A phase angle (1st order)			
	Analog input voltage, 1CH, 2CH			
	V/A unbalance ratio	●	●	●
	1-min Voltage flicker	●	●	●
	Short-term V Flicker (Pst)			
	Long-term V Flicker (Plt)			
	Capacitance calculation			
	Active power energy (consumption/ regenerating)			
	Reactive power (consumption) lagging/ leading			
	Apparent power energy (consumption/ regenerating)			
	Reactive power (regenerating) lagging/ leading			
	Demand (W/VA)			
Target demand (W/VA)				
Total harmonic distortion of V(F/R)				
Total harmonic distortion of A(F/R)				
Harmonics measurement	Harmonic V/ A(1-50th order)			
	V/ A phase angle (1-50th order)		●	
	V/ A phase difference (1-50th order)			
	Harmonic power (1-50th order)			
V/ A Change	RMS voltage per half-cycle			●
	RMS current per half-cycle			●
Event type	Event detected date & time			●
	Event type			●
	Measured values at event detection			●
Waveform	V/A waveform			●

Recording method

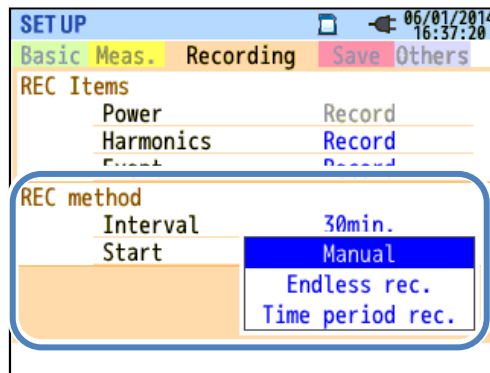

“Interval”

Set the interval to record the measured data on the SD or internal memory. Seventeen different intervals are available, but it cannot be set to a longer time than the demand measurement cycle. The preset recording interval may be changed automatically according to the selected demand measurement cycle. Please refer to “**Settings of demand measurement**” (P. 59) in this manual.

Selection
1 sec/ 2 sec/ 5 sec/ 10 sec/ 15 sec/ 20 sec/ 30 sec/
1 min/ 2 min/ 5 min/ 10 min/ 15 min/ 20 min/ 30 min/
1 hour/ 2 hours/ 150,180 cycles (approx. 3 sec)

* Default setting is highlighted in gray.

* The intervals: 150, 180 cycles (approx. 3 sec) are the ones defined in IEC61000-4-30. Data will be collected in 150 cycles at 50Hz (nominal frequency) and in 180 cycles at 60Hz (nominal frequency).



Move the blue highlight to “Interval”. → Show the list of the intervals. →

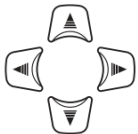

Select a desired interval. → Confirm. Cancel.

“Start”

Select the method to start recording.

Selection
Manual/ Constant rec./ Time period rec.

* Default setting is highlighted in gray.



Move the blue highlight to “Start”.



Show the pull-down menu.



Select a desired recording start method.



Confirm.



Cancel.

”Manual”

Start/ stop the recording with  Key.

“Constant recording”

Measured data will be recorded continuously at the preset interval during the specified start/ stop time and date.

Please refer to “(8)/ (9) **Setting for recording method**” (P. 45).

	Selection
Start time and date	Day/ Month/ Year Hour:Minute (00/00/0000 00:00)
Stop time and date	Day/ Month/ Year Hour:Minute (00/00/0000 00:00)



Move the blue highlight to “REC Start”/ “REC End”.



Show the value entry window.

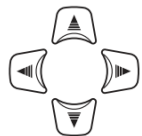

Specify the time and date.



Confirm.



Cancel.

“Time period recording”

Measured data will be recorded at the preset interval for the specified time period of the selected period. When the specified time comes, a recording will start and end automatically; such a recording cycle will be repeated everyday during the specified period. Please refer to “(8)/(9) Setting for recording method” (P. 45).

		Selection
REC Period	Start-Stop	Day/ Month/ Year (DD/ MM/ YYYY) - Day/ Month/ Year (DD/ MM/ YYYY)
REC Time	Start-Stop	Hour:Minute (hh:mm) - Hour:Minute(hh:mm)

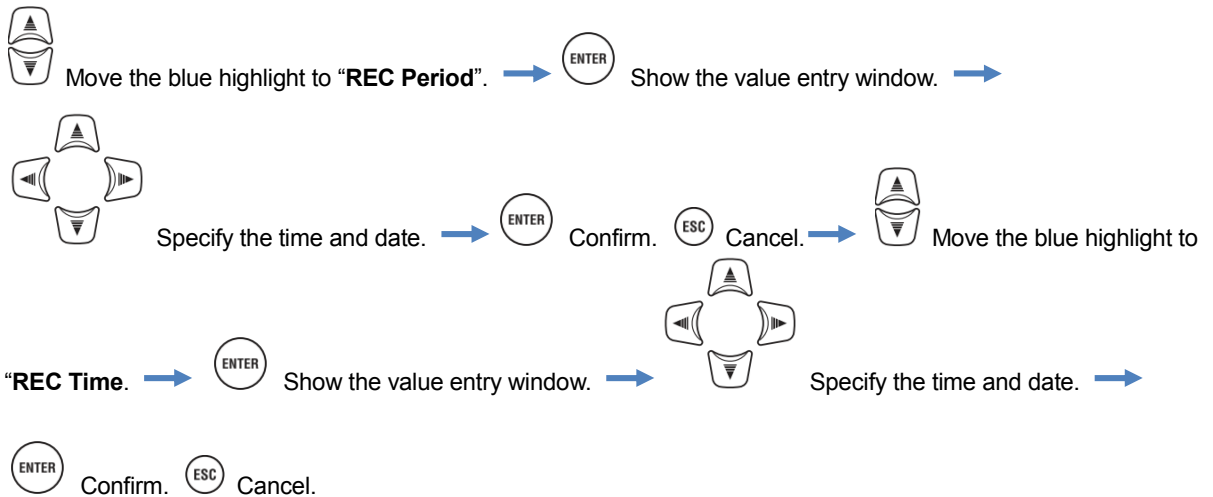

Possible recording time

When the 2GB of SD is used:

Interval	REC item		Interval	REC item	
	Power	+Harmonics		Power	+Harmonics
1sec	13days	3days	1min	1-year or more	3months
2sec	15days	3days	2min	2-year or more	6months
5sec	38days	7days	5min	6-year or more	1-year or more
10sec	2.5months	15days	10min	10-year or more	2-year or more
15sec	3.5months	23days	15min		3-year or more
20sec	5months	1month	20min		5-year or more
30sec	7.5months	1.5months	30min		7-year or more
			1hour		10-year or more
			2hours		
			150/180-cycle	23days	4days

* Data of power quality events are not considered to estimate the possible recording time. The max possible recording time will be shortened by recording such events. The max file size per recording is 1GB.

* Please ensure to use the SD cards provided with this instrument or as optional parts.

5.5 Other settings

Press the **SETUP** Key. →  Change the tabs to **"Others"**.

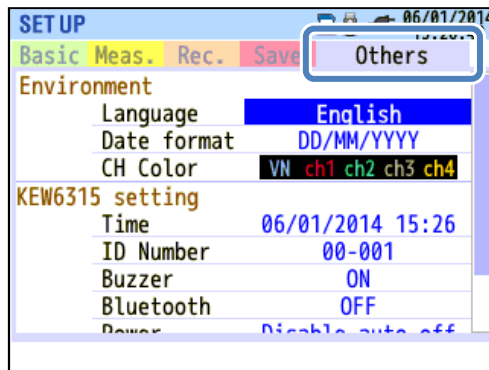

Settings for system environment

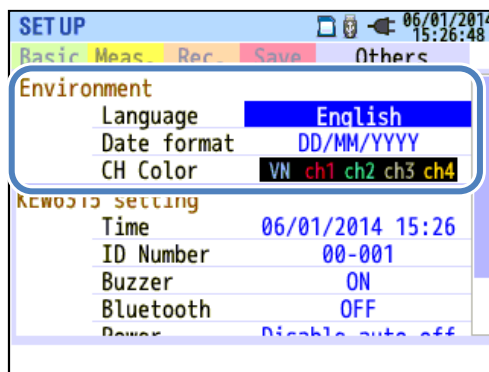

"Language"

Select the language to be displayed.

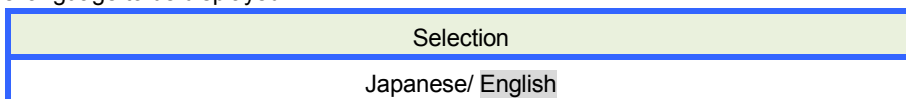

* Default setting is highlighted in gray. Changes made by user will remain after system reset.



Move the blue highlight to **"Language"**. →



Show the pull-down menu. →



Select a

desired language. →



Confirm. →



Cancel.

“Date format”

Select a desired date display format. The selected date format will be reflected to the date display on the screen and on each setting window.

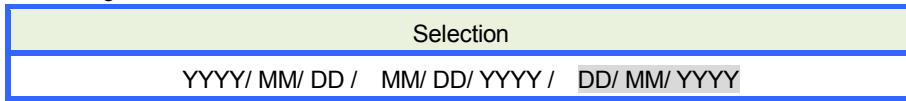

* Default setting is highlighted in gray. Changes made by user will not be cleared after system reset.



Move the blue highlight to “Date format”. →  Show the pull-down menu. →



Select a desired date format. →  Confirm.  Cancel.

“CH color”

Specify the colors for voltage and current per CH. The colors will be reflected into the characters on item label and lines on the graph and wiring diagram.

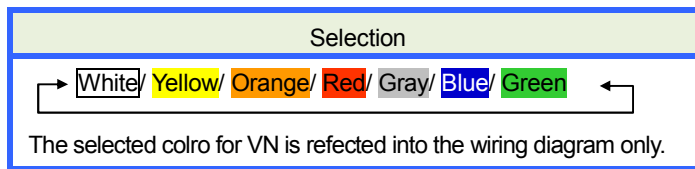

* Default color setting is: VN: Yellow/ 1CH: Red/ 2CH: White/ 3CH: Blue/ 4CH: Green.
Changes done by user will not be restored to default even after the system is reset.



Move the blue highlight to “CH Color”. →  Show the color setting window. →

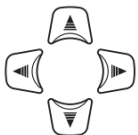

Select colors. →  Confirm.  Cancel.

KEW6315 Setting

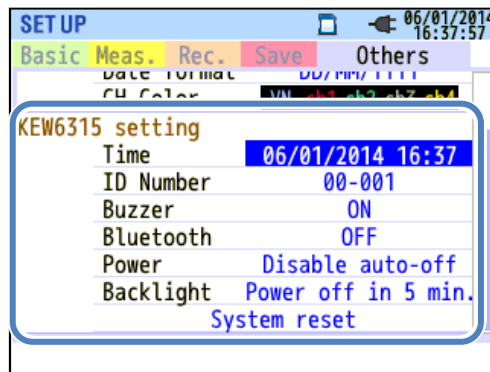

“Time”

Adjust and set the internal system clock.

Selection
dd/ mm/ yyyy hh:mm

* The selected date format has an effect on this setting.



Move the blue highlight to “Time”.



Show the value entry window.

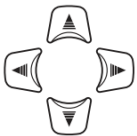

Adjust the time and date.



Confirm.



Cancel.

“ID Number”

Assign an ID number for the unit. Assigning ID numbers will be helpful to use multiple units at the same time or measuring multiple systems with one unit periodically and analyze the recorded data.

Selection
00-001 to 99-999 (00-001)

* Default setting is highlighted in gray.



Move the blue highlight to “ID Number”.



Show the value entry window.

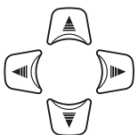

Enter an ID number.



Confirm.



Cancel.

“Buzzer”

Keypad sounds can be muted. The warning buzzer for demand judgment or low battery voltage sounds even “OFF” is selected.

Selection
On/ Off

* Default setting is highlighted in gray.



Move the blue highlight to “Buzzer”.



Show the pull-down menu.



Select On/ Off.



Confirm.



Cancel.

“Bluetooth®”

Turn on/ off the Bluetooth® function. Select “Off” if Bluetooth® communication will not be performed.

Selection
On/ Off

* Default setting is highlighted in gray.



Move the blue highlight to “Bluetooth®”.

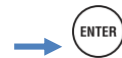

Show the pull-down menu.



Select On/ Off.



Confirm.



Cancel.

“Power”

Select to enable or disable the auto-power-off function. This setting is for the case KEW6315 operates with an AC power supply. Auto-power-off activates in 5 min after the last operation while KEW6315 is operating with batteries.

For:	Selection
AC Power	Power off in 5 min. / Disable auto-off
Battery	Power off in 5 min.

* Default setting is highlighted in gray.



Move the blue highlight to “Power”.



Show the pull-down menu.



Select either turning on/ off the auto-off function.



Confirm.



Cancel.

“Backlight”

This setting can turn off the backlight automatically when the prescribed time passes after the last key operation. The backlight will be turned off in 2 min after the last operation while KEW6315 is operating with batteries.

For:	Selection
AC Power	Power off in 5 min. / Disable auto-off
Battery	Power off in 2 min.

* Default setting is highlighted in gray.



Move the blue highlight to “**Backlight**”.



Show the pull-down menu.



Select either turning on/ off the auto-off function.



Confirm.



Cancel.

“System reset”

Restore all the settings to default except for “Language”, “Date format”, “CH Color” and “Time”.



Move the blue highlight to “**System reset**”.



Show a confirmation message.

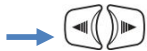

Select “Yes” or “No”.





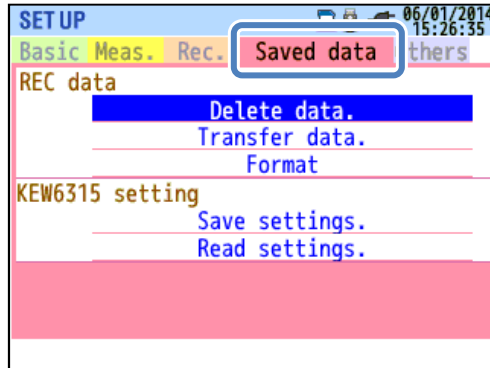

Restore the settings to default.

5.6 Saved data

Press the **SETUP** Key. →  Change the tabs to "Saved data".



Save the " ": Measurement data, " ": Print screen" and " ": Setting data" on the "  "SD card or in the "  " internal memory. If SD card is inserted in the instrument, these data will be automatically saved on the SD card. Remove or do not insert the SD card to save the data in the internal memory. Data save destination is not adjustable. Max number of the file that can be saved in the internal memory is: 3 for measurement data and 8 for the other data.

To delete, transfer or format the recorded data

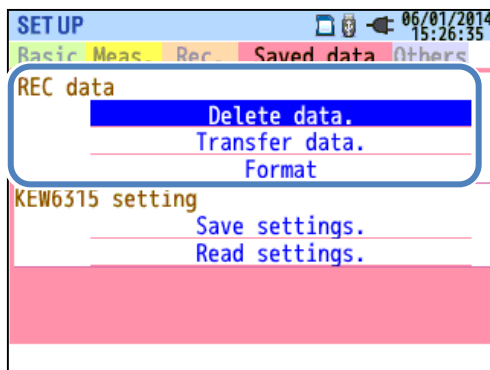





Select a desired operation. →



Confirm.

“Delete data”

Show the list of the recorded data, and then select unnecessary data.

Icons on the screen means: : SD card, : Internal memory, : Measured data, : Print screen, : Setting data

Data are not listed in time sequence. The recorded date and time are displayed to the right of file name. As for the data which are previously transferred from the internal memory to an SD card, the displayed time means when the data were transferred. The scroll bar is displayed when the list of the recorded data exceeds the display area.

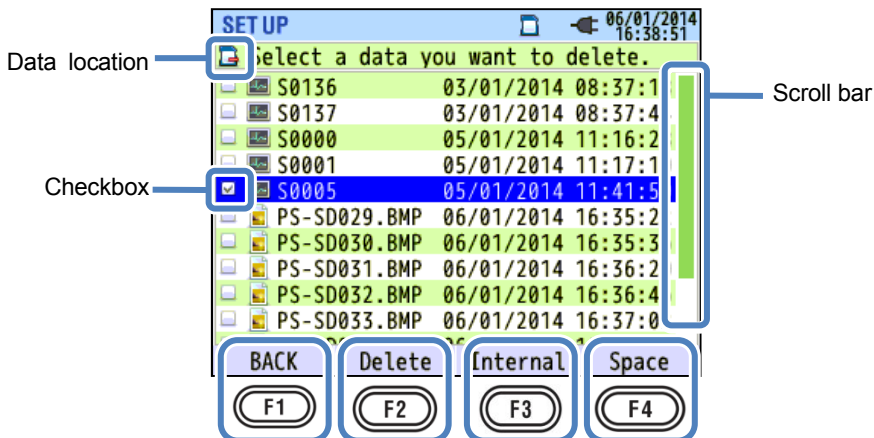

Move the blue highlight to the data you want to delete.



Confirm.



A confirmation

message will appear.



Select “Yes” or “No”.



Delete the data.

A check mark “” will be put in the checkbox for the selected data. Multiple data can be selected at once.

“Delete”

Press the  Key and select “Yes” on the confirmation message to delete the data.

“Internal”/ “SD card”

Pressing the  Key can switch between “Internal memory” and “SD Card” and the corresponding icon will be displayed in the upper left of the screen. Checked boxes will be cleared if the screens are switched before deleting the data.

“Space”

Storage media information can be checked with the **F4** Key. Press the **ENTER** Key to close the information window.

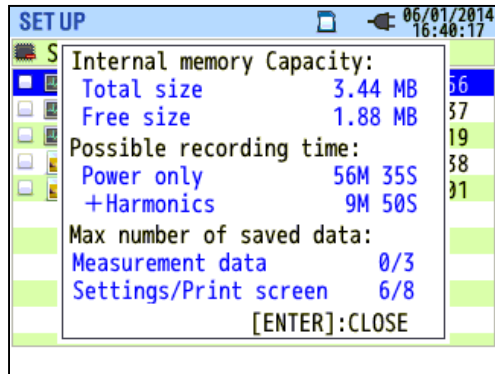
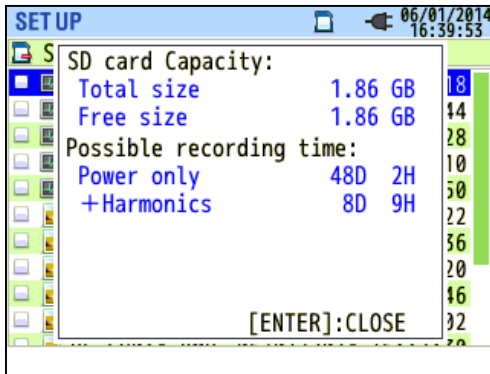





Displayed items		Selection
Capacity	Total size	Total memory capacity
	Free size	Capacity of free space
Possible recording time	Power only	Estimated possible recording time if the parameters to be recorded are limited to power-related ones only.
	Power+ Harmonics	Estimated possible recording time if the parameters to be recorded are power-related ones and harmonics.
Max number of saved data * Internal memory only	Measurement data	Number of measurement data files saved in the memory * Max number of files: 3
	Settings/ Print screen	Number of KEW6315 setting and print screen data files * Max number of files: 8

“BACK”

To return to the “Saved data” screen, press the **F1** Key.

“Transfer data”

Select the data you want to transfer from the “”: internal memory to the SD card “”.

Data files which can be transferred are: “”: Measurement data, “”: Print screen, “”: Setting data.

Data are not listed in time sequence. The recorded date and time are displayed to the right of file name.

As for the data which are previously transferred from the internal memory to an SD card, the displayed time means when the data were transferred. The scroll bar is displayed when the list of the recorded data exceeds the display area.

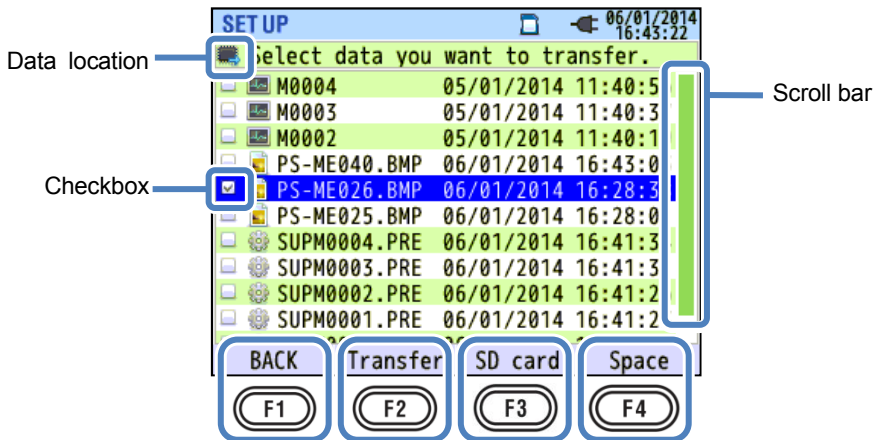

Select the data you want to transfer.



Confirm.



A confirmation message will

appear.



Select “Yes” or “No”.





Selected data will be transferred.

A check mark “” will be put in the checkbox for the selected data. Multiple data can be selected at once.



“Transfer”

Press the  (Transfer) Key and select “Yes” on the confirmation message to transfer the selected data.

“SD card”

To check the data on the SD card, press the  (SD card) Key. Pressing the  Key again returns to the list of data saved in the internal memory. Checked boxes will be cleared if the screens are switched before transferring the data.



“Space”

Storage media information can be checked with the  Key. Press the  Key to close the information window. Please refer to “**Space**” (P. 84) for further details.

“BACK”

To return to the “Saved data” screen, press the  Key.

“Format”

Format the : SD card or : Internal memory. Data are not listed in time sequence. The recorded date and time are displayed to the right of file name. As for the data which are previously transferred from the internal memory to an SD card, the displayed time means when the data were transferred. The scroll bar is displayed when the list of the recorded data exceeds the display area.

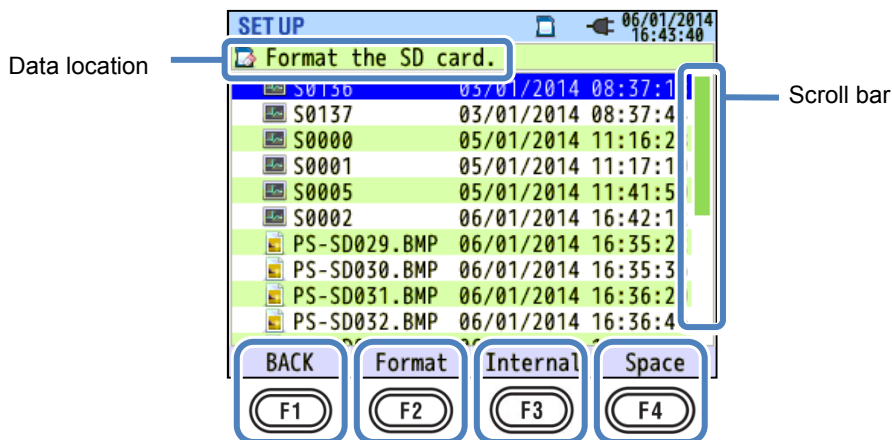

 A confirmation message will appear. →  Select “Yes” or “No”. →  Format.



“Format”

A confirmation message will appear when pressing the  (Format) Key. Select “Yes” to start format.

“Internal”/ “SD card”

Pressing the  Key can switch between “Internal memory” and “SD Card” and the corresponding icon will be displayed in the upper left of the screen.

“Space”

Storage media information can be checked with the  Key. Press the  Key to close the information window. Please refer to “Space” (P. 84) for further details.

“BACK”

To return to the “Saved data” screen, press the  Key.

Type of the saved data



Data file handling

The file name will be assigned automatically. File no. is kept and saved, even after powering off the instrument, until the system is reset. The file number will increase until it exceeds the max file number. If a file with the same file name already exists, the files in the data folder will be saved as another name with a different file number. The file number will be automatically increased by 1. However, "Print screen" and "Setting" files will be overwritten in such a case. When the file number starts from "0" or one same SD is used for multiple instruments, extra cautions should be paid so that necessary files will not be overwritten. When all the file numbers are used for each type of data, the files on the data folder will be overwritten.

If files are deleted or the name of folder or file are changed on a PC, editing on the instrument or data analysis with special software cannot be performed. Please do not change the name of folder or file.

"Print screen"

Press the  to save the screen images as BMP files.

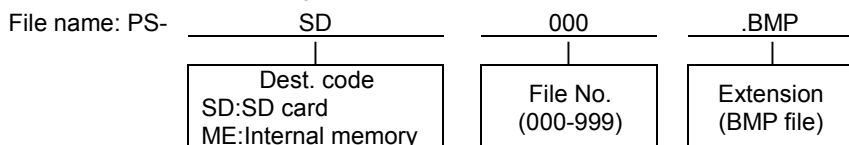

* Dest. = Destination

"KEW6315 Setting"

Press the  key and move to "Saved data" tab, and then select "Save Settings".

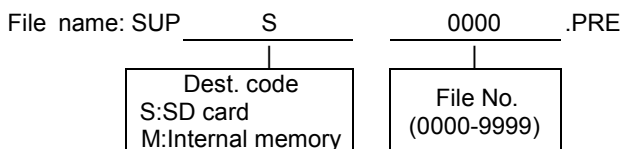

“Data folder”

New folder will be created per measurement to save the interval and power quality data.

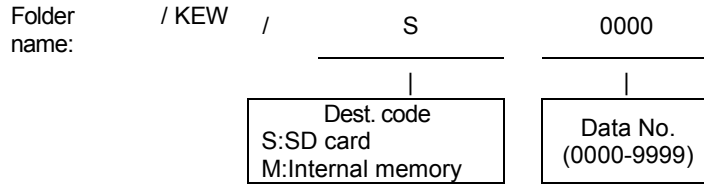

“Interval data”

KEW6315 setting	File name	SUP	S	0000	.KEW
Measurement setting		INI	S	0000	.KEW
Power measurement		INP	S	0000	.KEW
Harmonics measurement		INH	S	0000	.KEW
			Dest. code S:SD card M:Internal memory	Data No. (0000-9999)	

“Power quality data”

Event type	File name	EVT	S	0000	.KEW
Waveform		WAV	S	0000	.KEW
V/ A change		VAL	S	0000	.KEW
			Dest. code S:SD card M:Internal memory	Data No. (0000-9999)	

KEW6315 settings and Data loading

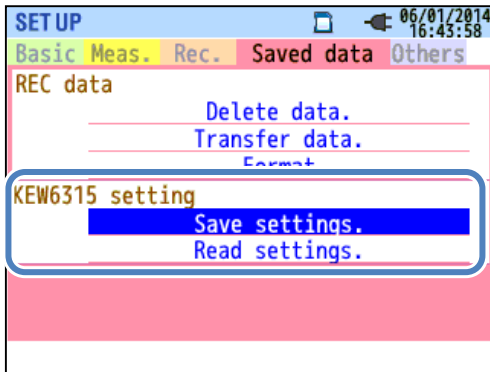

Select a desired operation. →



Confirm.

“Save settings”

Save the “”: Setting data on the “”: SD card or in the “”: internal memory. Data are not listed in time sequence. The recorded date and time are displayed to the right of file name. As for the data which are previously transferred from the internal memory to an SD card, the displayed time means when the data were transferred. The scroll bar is displayed when the list of the recorded data exceeds the display area.

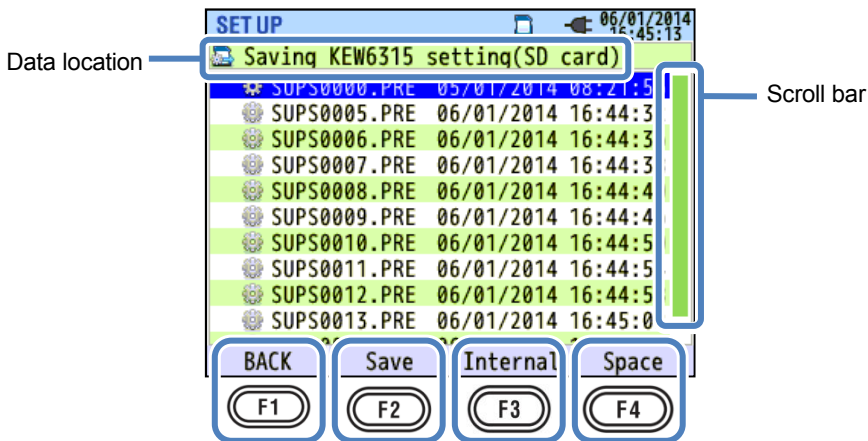

A confirmation message will appear. →



Select “Yes” or “No”. →



Data will be saved.



“Save”

Press the Key and select “Yes” on the confirmation message to save the data on the SD card or in the internal memory.

“Internal”/ “SD card”

Pressing the Key can switch between “Internal memory” and “SD Card” and the corresponding icon will be displayed in the upper left of the screen.

“Space”

Storage media information can be checked with the  Key. Press the  Key to close the information window. Please refer to “**Space**” (P. 84) for further details.

“BACK”

To return to the “Saved data” screen, press the  Key.

The following settings for KEW6315 can be saved.

Basic setting

Setting item
Wiring
Voltage range
VT ratio
Nominal voltage
Clamp/ Current range
CT ratio
DC range
Frequency

Other settings

Setting item	
Environment	Date format
KEW6315 setting	ID number
	Buzzer



Measurement setting

Setting item	
Demand	Measurement cycle
	Inspection cycle
	Target
Harmonics	THD(total harmonic distortion) calc.
	Allowable range
	MAX HOLD
Power quality	Threshold for Hysteresis
	Threshold for Transient
	Threshold for Swell
	Threshold for Dip
	Threshold for INT
	Threshold for Inrush current
Flicker	Filter coefficient (Ramp)
Capacitance calculation	Target PF





Recording setting

Setting item	
Recording item	Harmonics
	Power quality (event)
Recording method	Interval
	Start
Constant meas.	REC Start
	REC End
Time period rec.	Rec. period Start - End
	Time period Start - End

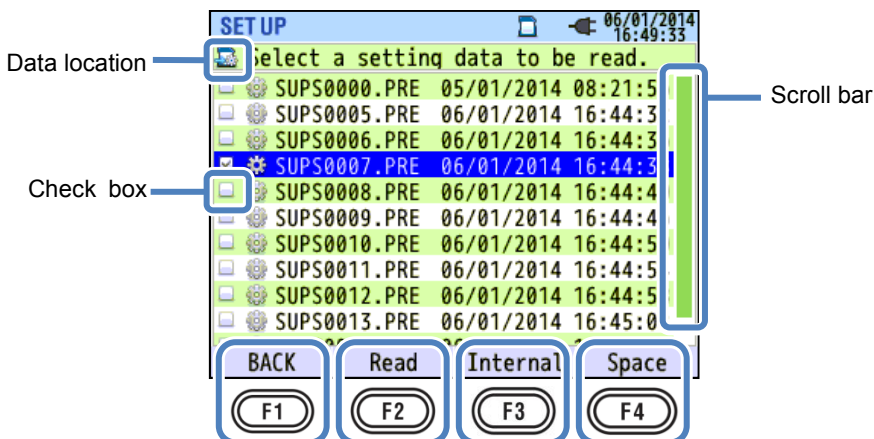
“Read settings”

Read the “”: Setting data from the “”: SD card or from the “”: internal memory. Data are not listed in time sequence. The recorded date and time are displayed to the right of file name. As for the data which are previously transferred from the internal memory to an SD card, the displayed time means when the data were transferred. The scroll bar is displayed when the list of the recorded data exceeds the display area.



 Select the data you want to transfer. →  Confirm. →  A confirmation message will appear. →  Select “Yes” or “No”. →  Confirm.

The scroll bar is displayed when the list of the recorded data exceeds the display area. A check mark “” will be put in the checkbox for the selected data.



“Read”

Press the  (Transfer) Key and select “Yes” on the confirmation message to transfer the selected data.

“Internal”/ “SD card”

Pressing the  Key can switch between “Internal memory” and “SD Card” and the corresponding icon will be displayed in the upper left of the screen.

“Space”

Storage media information can be checked with the  Key. Press the  Key to close the information window. Please refer to “Space” (P. 84) for further details.

“BACK”

To return to the “Saved data” screen, press the  Key.

Chap. 6 Displayed Items

6.1 Instantaneous value "W"

Press the **W/Wh** Key. → **F1** Display the screen for "W": Instantaneous value.

List display of the measured values

F2 "List" (/Zoom)

e.g.) Instantaneous values measured under 3P3W3A+1A (Three-phase Three-wire + Current (optional sensor))

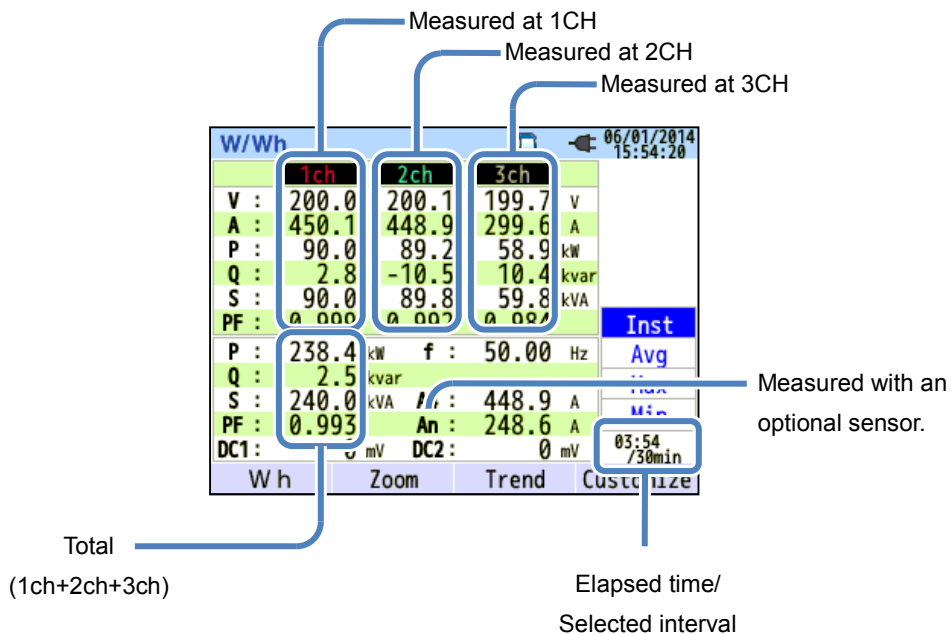

Multiple measured values can be displayed on one screen. The displayed items can be changed by pressing the corresponding keys.

Symbol displayed on the LCD					
V ^{*1}	Phase voltage	VL ^{*1}	Line voltage	A	Current
P	Active power + consumption - regenerating	Q	Reactive power + Lagging - leading	S	Apparent power
PF	Power factor + Lagging - leading	f	Frequency		
DC1	Analog input Voltage at 1ch	DC2	Analog input Voltage at 2ch		
An ^{*2}	Neutral current	PA ^{*3}	V/A Phase difference + Lagging - leading	C ^{*3}	Capacitance calculation

^{*1} W screen: Displays of V and VL can be “customized” when “3P4W” is selected.

^{*2} W screen: “An” is displayed only when “3P4W” is selected.

^{*3} W screen: Displays of PA and C can be “customized” with the  (customize) Key. Line voltages are converted into phase voltages to determine currents and phase angles for “PA” of 3P3W3A.

e.g.) Instantaneous values measured under 1P3W-2 (2 systems)

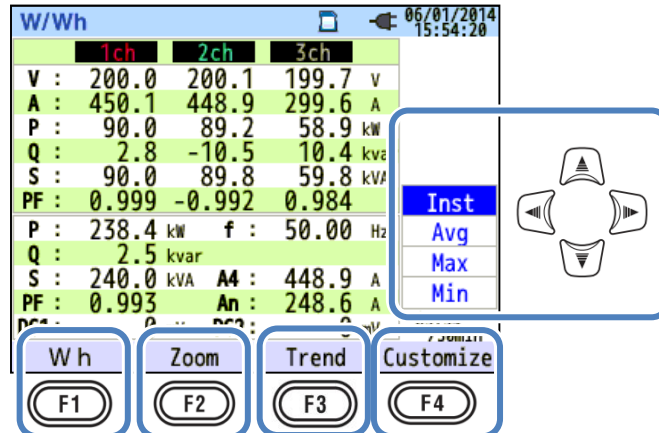

“Switching the displayed systems”

Press the  key and switch the displayed systems. Items displayed in a screen depend on the selected wiring configuration and the number of systems. The dotted lines represent the space of each display area.

1P2W-1 to -4 (Single phase, 2-wire, 1 – 4 systems)

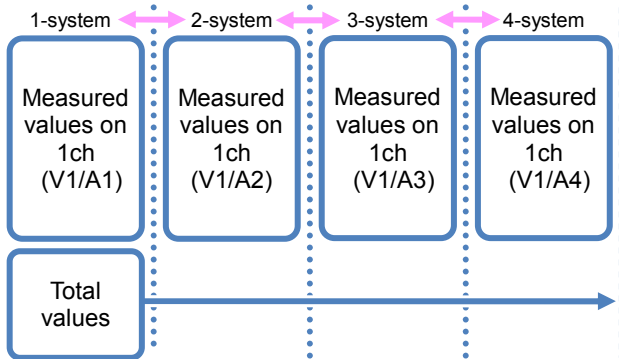

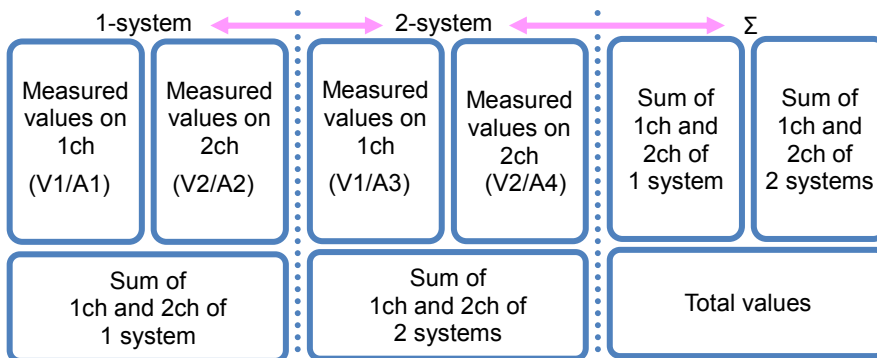

1P3W-1, -2 (Single phase, 3-wire, 1 or 2 systems)

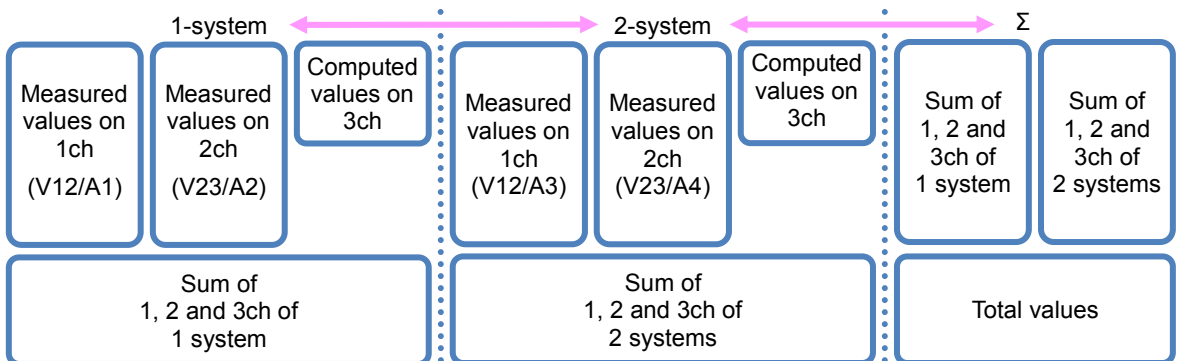

3P3W-1, -2 (Three-phase, 3-wire, Blondel's theorem, 1 or 2 systems)

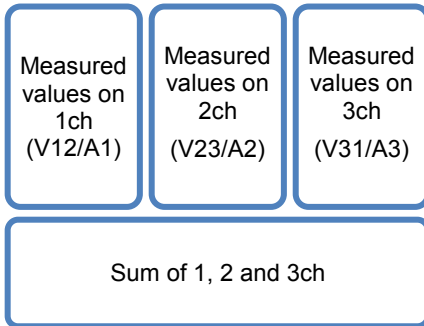
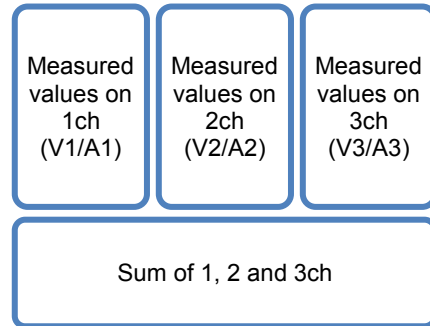

3P3W3A (Three-phase 3-wire)**3P4W (Three-phase 4-wire)****“Switching the type of displayed values”**

The displayed values can be switched between Inst, Avg, Max and Min values with  key. If the selected interval is “1 sec”, Inst, Avg, Max and Min values will be the same since the display update is also “1 sec”.

“Wh” Integration value

Press the  (Wh) key and switch the screens to view integration values. Please refer to “**6.2 Integration value [Wh]**” (P. 100) in this manual.

“Zoom”

Four or eight measured values can be zoomed and displayed on one screen by pressing the  (Zoom) key. Please refer to “**Zoom display**” (P. 96) in this manual.

“Trend graph”

Press the  (Trend) key to show the trend graphs. The displayed time area is from present to the past 60 min. Please refer to “**Displaying Trend graph**” (P. 97) in this manual.

“Customize”

Press the  (Customize) key to switch the displayed items and change the display positions. Please refer to “**Changing displayed items and display position**” (P. 99) in this manual.

Zoom display

Example: 8-split screen

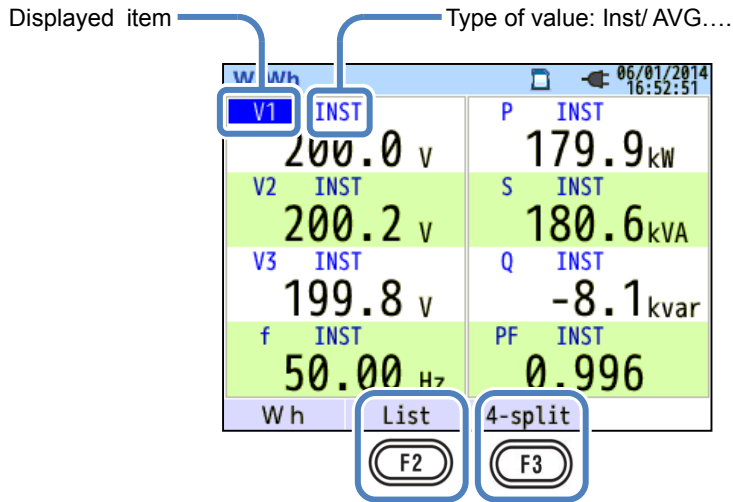

Select 4 or 8 values and display the values on one screen. The displayed text will be enlarged so it is easy to see.

”Displayed items”

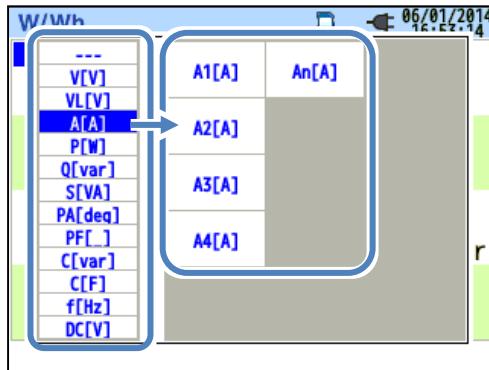

Select the items to be displayed in each column. Then, the selectable items will be displayed to the right.

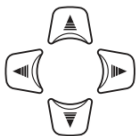

Move the blue highlight to a Displayed item in any column. → Show the list.

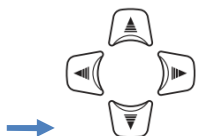

→ Select a desired item to be displayed. → Confirm. Cancel.

"Type of value"

Any of the following values can be displayed in each column.

Inst: Instantaneous value, or AVG: Average value, MAX: Maximum value or MIN: Minimum value within the selected interval.

If the selected interval is "1 sec", Inst, Avg, Max and Min values will be the same since the display update is also "1 sec".

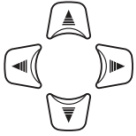

Move the blue highlight to a Type of value in any column. →



Show the pull-down menu.



Select a desirable type. →



Confirm. →



Cancel.

"List display"

Press the **F2** (List) key to display all the values on the list.

"4-Split"/ "8-Split"

Press the **F3** (4-Split/ 8-Split) key to expand and display 4 or 8 items on one screen.

Displaying Trend graph

In the following example, active powers per ch for 1P3W-2 (Single-phase 3-wire, 2-system) are displayed on the graph.

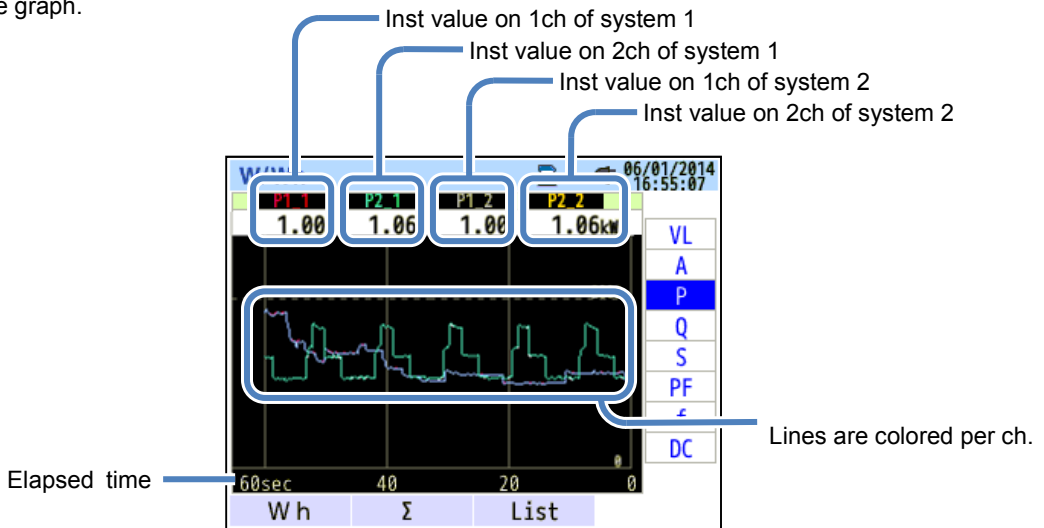

Changes of each measured values can be displayed on the graph.

The following example shows 1P3W-2 (Single-phase 3-wire, 2-system).

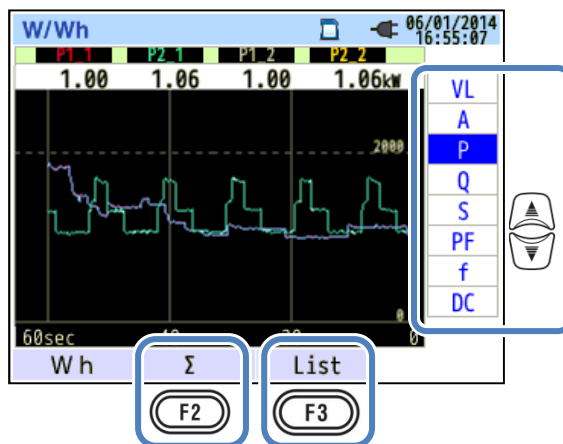

”Change the items displayed on Trend graph”



Press the  key and change the items displayed on the trend graph.

“Σ/CH”

Press the  (Σ/CH) key to switch the graphs: one is to display the sum and total values per system and another is to display the values per ch. The selection of “Σ” or “CH” will be effective for all the trend graphs. When “Σ” is selected, while A: rms current values is selected for 3P4W, An: neutral current values will be displayed on the trend graph.

“List display”

Press the  (List) to show all the values on a list.

Changing displayed items and display position

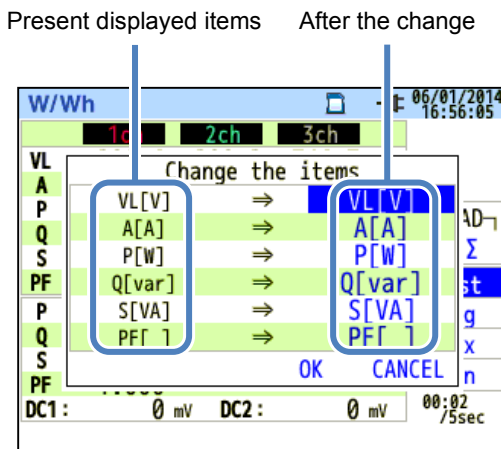

The displayed items can be changed to any desired ones.



Move the blue highlight to the item you want to change.



Show the pull-down menu.



Select a desired item.



Confirm.



Cancel.



Select OK/ Cancel.



Confirm.



Cancel.

When opening the "Change the items" window, presently displayed items are displayed in two rows.

The presently displayed items are displayed on the left, and the items to be displayed after the change are displayed in blue on the right. Displayed positions are basically separated into two large categories: one is for voltage/ current and another is for power/ capacitance calc.. For the details about the symbols displayed on the screen, please refer to "**List display of the measured values**" (P. 93).

6.2 Integration value "Wh"

Press the **W/Wh** Key. → **F1** Display the screen for "Wh": Integration value.

e.g.) 1P3W-2 (Single-phase Three-wire, 2-system)

The screenshot shows the 'W/Wh' screen with the following data:

- Elapsed time: 00000:00:05
- Active: WP+ : 249.887 Wh, WP- : 0.000 Wh
- Apparent: WS+ : 250.837 VAh, WS- : 0.000 VAh
- Reactive: WQi+ : 0.000 var, WQc+ : -11.286 var
- DEMAND

A control menu is overlaid on the right side of the screen, showing:

- LOAD
- 1 2 Σ (Total amount)
- Σ (sum per system)
- 1ch
- 2ch

Power used in the certain period is displayed as integral power consumption. Integral power consumption is used to calculate electricity tariffs or to control the power consumption.

Symbols displayed on the screen									
WP	Active power energy	+	consumption	WQ	Reactive power energy	+	lagging	WS	Apparent power energy
		-	regenerating			-	leading		regenerating

e.g.) 1P3W-2 (Single-phase Three-wire, 2-system)

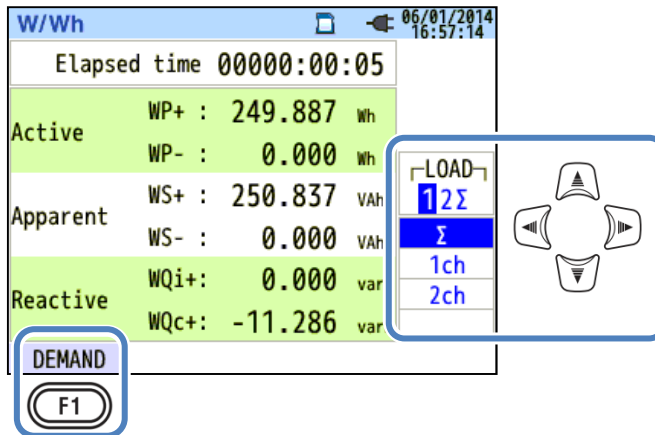

"Change the displayed systems"

Press the  Key to switch the displayed systems. Please refer to "**Setting of wiring system**" (P. 49) in this manual.

"Change the displayed chs"

Press the  Key to switch the displayed channels. Please refer to "**Setting of wiring system**" on (P. 49) in this manual.

"Demand"

Press the  (Demand) Key to display the screen for demand value. Please refer to "**6.3 Demand**" (P. 102) in this manual.

6.3 "Demand"

Press the  Key. →  Display the screen for demand value.



→ Change the screens to display the demand measurement results in various forms.

Showing the measured values



Move the blue highlight to "Meas.".

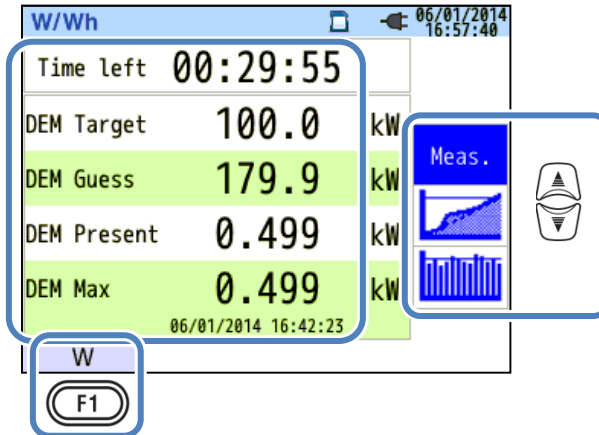

The demand is the average powers recorded over a certain period. When the estimated value exceeds the target value during demand measurements, the warning buzzer sounds at the inspection cycles.

Items displayed on the LCD	
Remaining time (time left)	Demand interval is counted down.
DEM Target	Demand target value.
DEM Guess	Predicted demand value (average power) when preset demand interval elapses under present load. $\frac{\text{(Present value)} \times \text{(Present interval)}}{\text{(Elapsed time)}}$ * Integration and calculations are done as time elapses.
DEM Present	Demand value (average power) within a demand interval. $\frac{\text{"WP+ x 1 hour"}}{\text{Interval}}$ * Integration and calculations are done as time elapses.
DEM Max	Max demand recorded during a measuring period is displayed. Displayed value will be
Recorded date	refreshed if any higher demand is detected.

Instantaneous value "W"

Press the  (W) Key to show instantaneous values on the screen. Please refer to "6.1

Instantaneous value "W" (P. 92) in this manual for further details.

Shifts in specific period

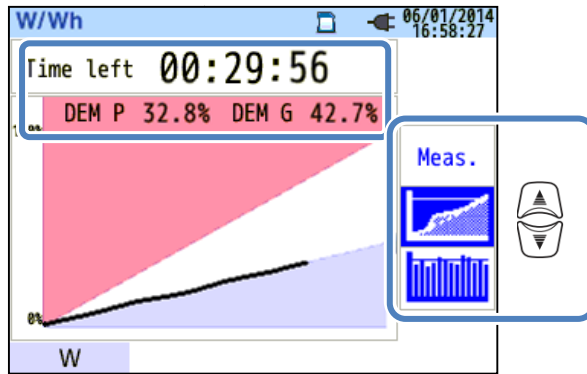

Items displayed on the LCD	
Remaining time (time left)	Demand interval is counted down.
DEM P	Percentage of the present value against the target value. $\frac{\text{Present value}}{\text{Target value}}$ is displayed.
DEM G	Percentage of the predicted value against the target value. $\frac{\text{Predicted value}}{\text{Target value}}$ is displayed.

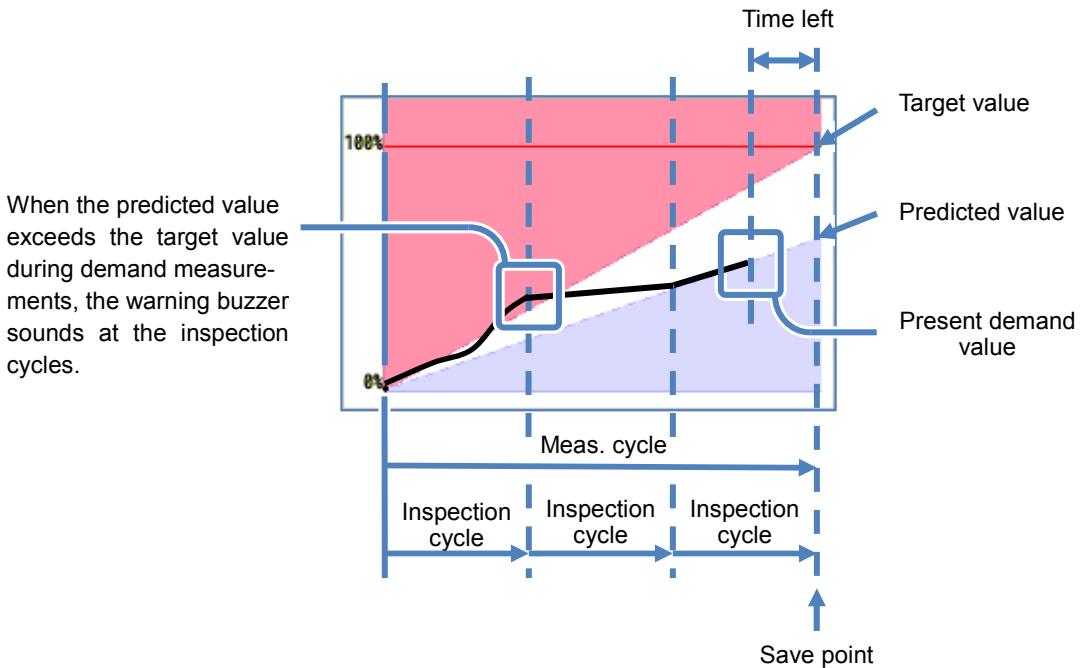

Demand change

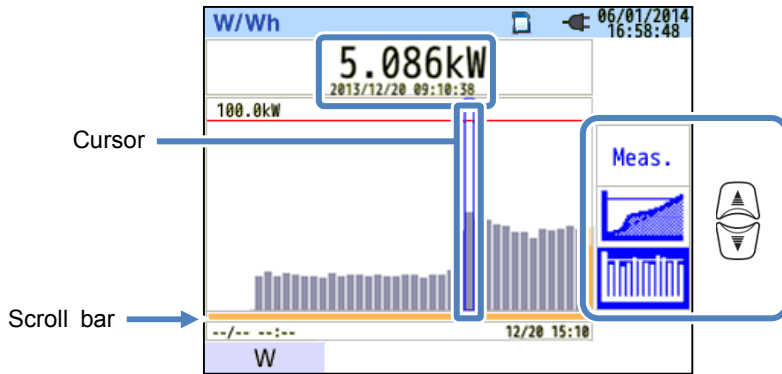

Press the  Key to move the cursor and to scroll the graph to right and left. The white bar shows the percentage of hidden pages and the dark orange bar shows the percentage of the present displayed page.

Items displayed on the LCD	
Measured demand/ Recorded date	Demand value is displayed with recorded date & time info where the cursor is located.

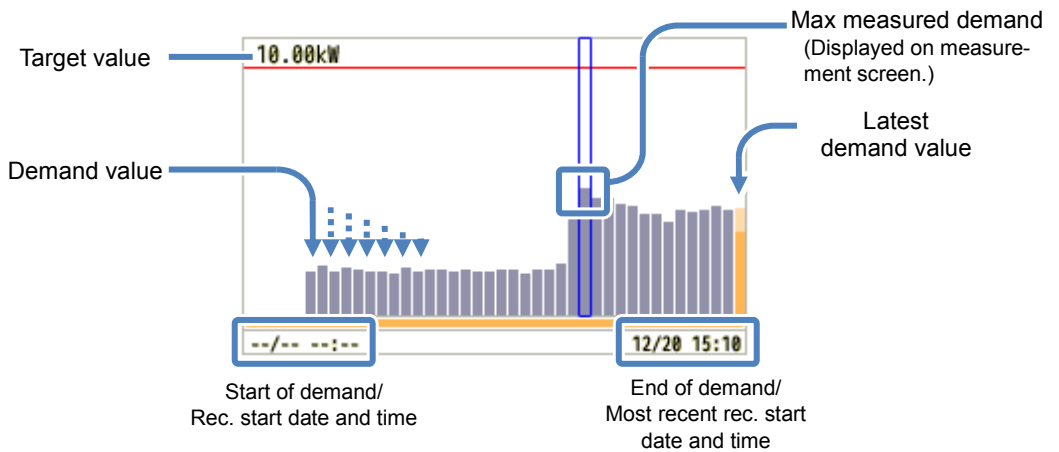

Start of demand/ Rec. start date and time is displayed when the graph exceeds the display area.

6.4 Vector

Press the  Key.
e.g.) 3P4W

Vector display

Measured values

V: rms voltage*¹ /Phase angle*²
A: rms current / Phase angle*²

*¹ For 3P3W3A, rms line voltages are displayed.

*² Phase angled is displayed: using Phase of V1 as the base (0°).

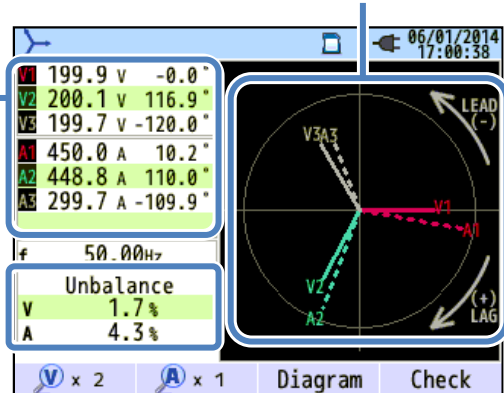

Vector display:

rms voltage (solid line)
rms current (dotted line)

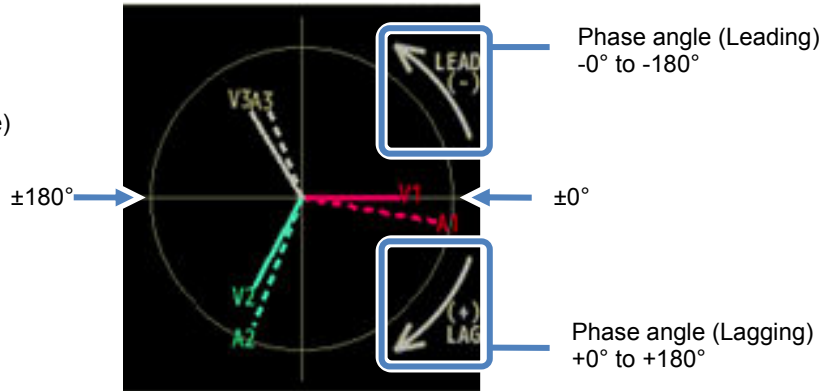

The circle (solid line) represents the max values at V and A Ranges, and the line length represents rms voltage and current values. The angle between the lines represents phase relation with reference to V1. For 3P3W3A/3P4W, unbalance ratio is also displayed. While the measured voltages and currents are balanced, the following vectors will be displayed.

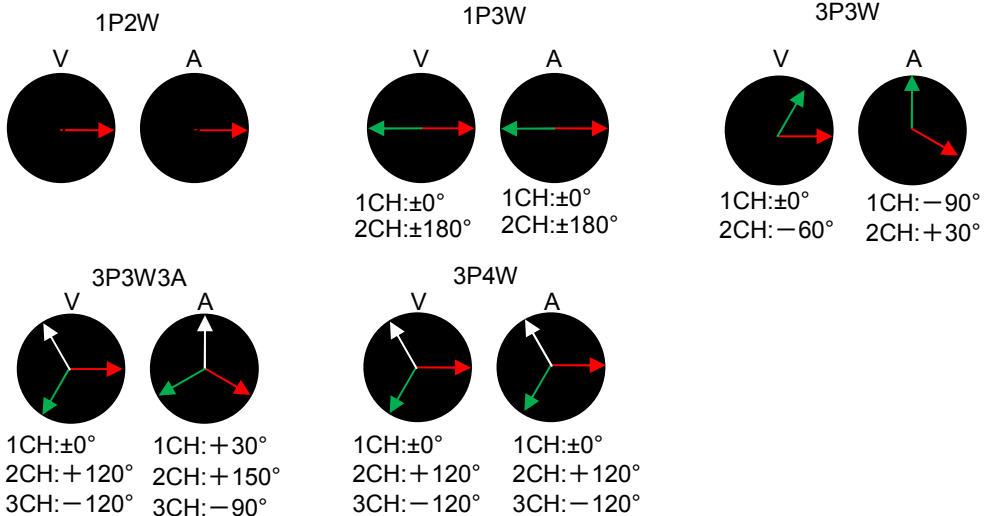

e.g.) Vector of 3P4W:

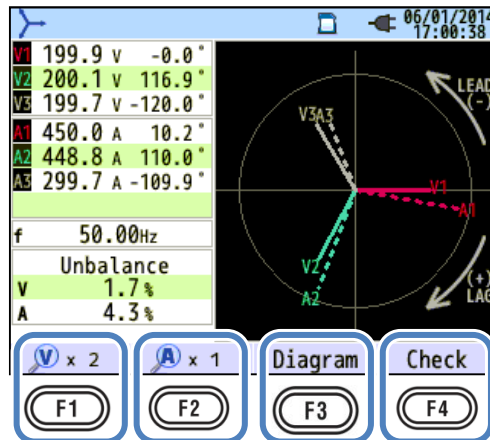

”V x desired magnification”

F1 : toggle the line lengths of voltage vector.

1 → 2 → 5 → 10 *time(s)

”A x desired magnification”

F2 : toggle the line lengths of current vector.

1 → 2 → 5 → 10 *time(s)

“Diagram”

Press the **F3** (Diagram) Key to show the wiring diagram for the selected wiring configuration. Please refer to “**Wiring diagram**” (P. 50) in this manual for further details.

”Check”

Press the **F4** (Check) Key to check the wiring connections and show the result. * NG result may be given, even if the wiring is correct, at the measurement site under bad power factors. Please refer to “**Wiring check**” (P. 43) in this manual for further details.

6.5 Waveform

Press the  Key.

e.g.) Waveform of 1P3W-2 (Single-phase 3-wire, 2-system):

Measured values
 V: rms voltage*
 A: rms current

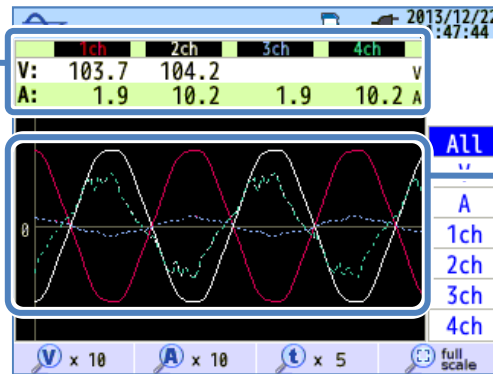

* For 3P3W3A, rms line voltages are displayed.

Colored waveforms per ch

Voltage and current waveforms are displayed: for 10 cycles max. at 50Hz, for 12 cycles max. at 60Hz. When changing the screens for "Waveform", waveforms are displayed in the max scale automatically.

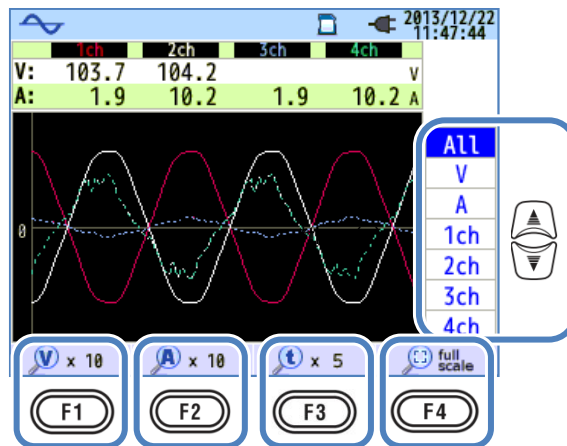

"Changing the displayed waveforms"

Press the  Key to change the displayed waveforms.

"V x desired magnification"

 : toggle the magnifications of voltage waveform (vertical).

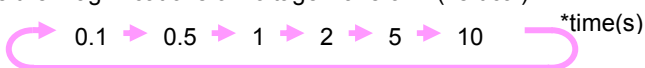

"A x desired magnification"

F2 : toggle the magnifications of current waveform (vertical).

0.1 → 0.5 → 1 → 2 → 5 → 10 *time(s)

"t x desired magnification"

F3 : toggle the magnifications of time axis (horizontal).

1 → 2 → 5 → 10 *time(s)

"full scale"

F4 : Restore all the changed magnification settings and automatically select the appropriate magnification.

6.6 Harmonics

Press the **Bar** Key.

Displaying harmonics on the bar graph

Press the **F1** (Graph) Key.

e.g.) The following represents 3P4W (Three-phase 4-wire) while "Linear" and "Full-scale display" are selected.



Symbols displayed on the LCD

V	Voltage	A	Current
	* For 3P3W3A, rms line voltages are displayed.		
THD	Voltage total harmonic distortion is displayed while "V" is displayed and current total distortion factor is displayed while "A" is displayed. Total harmonic distortion is calculated according to the selected THD calculation method.		
P	Active power per ch	ΣP	Sum of each ch/ total active power
	+ in - out		+ in - out

Bar graph display

e.g.) “Linearity” is displayed in “Full-scale”.

Rate of content

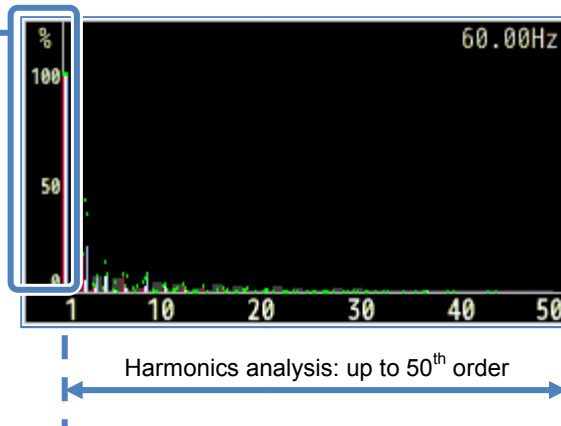



In the above example, “Linear” and “full-scale” are selected. In this case, the upper limit of the rate of content is “100%” and all harmonics, 1st to 50th, are displayed on one screen.

Item displayed on the LCD	
Rate of content	Harmonic content of each order against the 1st basic wave.

e.g.) The following represents 3P4W (Three-phase 4-wire) while “LOG” and “Zoom” are selected.

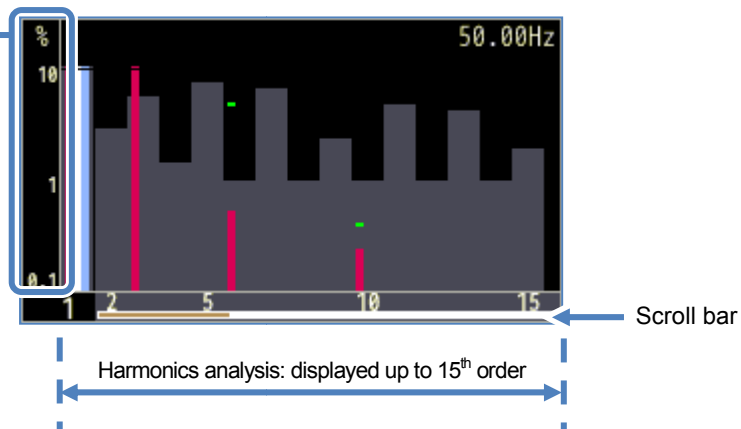
Rate of content



When selecting “LOG” (Logarithm), 10% will be the max percentage of the vertical axis and the harmonics displayed are limited up to 15th order. Press the  key to scroll the pages. The basic waveform of 1st order is fixed and does not move. The white bar shows the percentage of hidden pages and the dark orange bar shows the percentage of the present displayed page.

e.g.) 3P4W (Three-phase 4-wire) : with "LOG" and "Zoom".

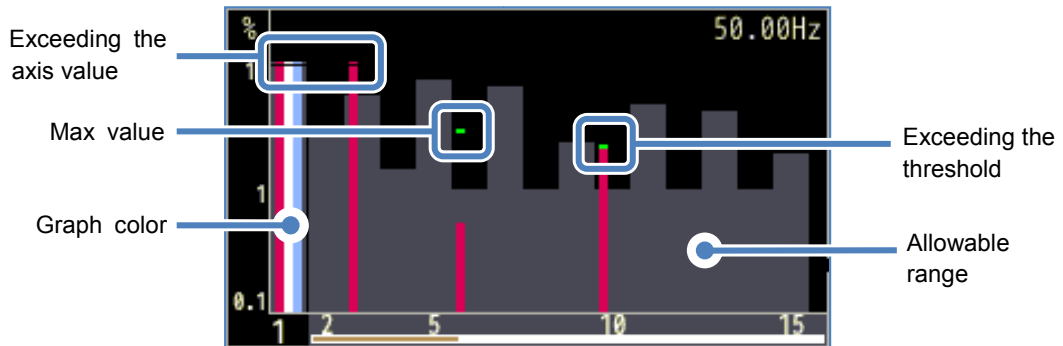

Items displayed on the graph	
Exceeding the axis value	Displayed when the rate of harmonics content of each order is more than 10%. The rate of harmonics content of the 1st basic waveform is "100%", therefore, always exceeding the axis value in "LOG" display.
Max value	Max values recorded during measurements are displayed. These values can be reset any of the following methods. * Setting change, * Start of recording, or * Long press (2 sec or longer) of  Key.
Graph color	When multiple measurement channels are used, each graph is displayed in different colors.
Exceeding the threshold	Displayed when measured values exceed the preset allowable range.
Allowable range	Preset by default and complied with IEC61000-2-4 Class3. To change the range, select "Edit allowable range." in the "Measurement" setting.

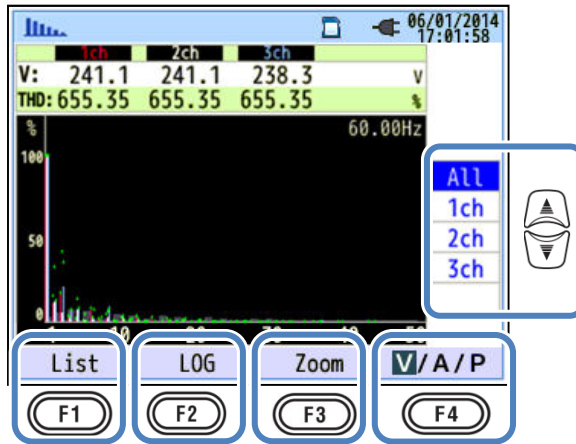

“Change the displayed chs”



Press the Key to change the displayed chs. The details about the relation between the wiring configuration and ch are described in “**Settings of wiring system**” (P.49).

“List”/“Graph”



Press the Key to display voltage/ current/ power harmonics, from 1st to 50th order, in list or graphic form. Only the rate of harmonics content can be checked on graph display screen, but rms value/ rate of content/ phase angle* can be checked respectively on list display screen.

* While “P”(Power) is selected and displayed, phase differences between voltage and current are displayed. Inflow: $\pm 0^\circ$ to $\pm 90^\circ$, Outflow: $\pm 90^\circ$ to 180° .

“LOG”/ “Linear”



Press the (LOG/Linear) Key to switch the display modes. Linear display, with ticks of 0% - 100%, and Logarithm display, with ticks of 0.1% - 10%, are switchable on the vertical axis. It is useful to analyze lower level of harmonics.

“Full”/“Zoom”



Press the (Zoom/Full) Key to zoom and display fifteen harmonics on one screen. Voltage/

Current/ Power harmonics are separately displayed in graphic form. Press the Key to scroll the pages.

“V/A/P/ΣP”



Press the (V/A/P/ΣP) Key and select the parameter to be analyzed.

Displaying the list of harmonics

Press the **F1** (List) Key to display the list of harmonics.

e.g.) "P: Power harmonics" and "Power" of 1P3W-2 (Single-phase 2-wire, 2-system) are listed.

P	P1.1	P2.1	P1.2	P2.2
1	88.5	89.1	-20.4	89.1kW
2	0.0	0.0	0.0	0.0kW
3	0.0	0.0	0.0	0.0kW
4	0.0	0.0	0.0	0.0kW
5	0.0	0.0	0.0	0.0kW
6	0.0	0.0	0.0	0.0kW
7	0.0	0.0	0.0	0.0kW
8	0.0	0.0	0.0	0.0kW
9	0.0	0.0	0.0	0.0kW
10	0.0	0.0	0.0	0.0kW
11	0.0	0.0	0.0	0.0kW

Graph Rate Σ P

Rms values, rate of content and phase angle of voltage/ current/ power harmonics, from 1st to 50th, can be displayed in list form respectively.

Items displayed on the LCD				
V	Voltage ^{*1}		A	Current
P ^{*2}	Active power per ch	+ in - out	ΣP ^{*2}	Sum of each ch / total active power + in - out

^{*1} For 3P3W3A, rms line voltages are displayed.

^{*2} The letters and numbers displayed on the top represent the displayed parameter and the ch or system number. If there is a space between the alphabet and the following number, the displayed no. represents the system no.. In this case, the listed values are sum per system. If "P" is displayed alone, the listed values are total amounts.

	A	A1	A2	A3	A4
1	450.0	448.9	299.7	448.8	
2	0.0	0.0	0.0	0.0	
3	0.0	0.0	0.0	0.0	
4	0.0	0.0	0.0	0.0	
5	0.0	0.0	0.0	0.0	
6	0.0	0.0	0.0	0.0	
7	0.0	0.0	0.0	0.0	
8	0.0	0.0	0.0	0.0	
9	0.0	0.0	0.0	0.0	
10	0.0	0.0	0.0	0.0	

”Change the displayed harmonics orders”

Press the  Key to scroll the page vertically.

”Graph”/ ”List”

Press the  Key to display voltage/ current/ power harmonics, from 1st to 50th order, in list or graphic form. Only the rate of harmonics content can be checked on graph display screen,

”Rate of content”/”Phase angle”/ RMS value (Power)”

Press the  (Rate/ DEG/ RMS) Key to change the displayed items on the list. While “V”:voltage or “A”: Current are displayed on the screen, Rate/ DEG (phase angle with V1 basis (0°)) / RMS are switchable. While “P” (ΣP): Power is displayed, Rate/ DEG (voltage/ current phase angle per ch) / Power are switchable.

“V”/”A”/”P/ΣP”

Press the  (V/A/P/ΣP) Key and select the items to be analyzed: V: voltage/ A: Current/ P: Power (ΣP: Sum per system, Total amount).

6.7 Power quality

Press the  Key to display Power quality screen.

Factors impair power quality and symptoms

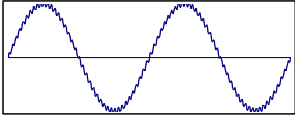
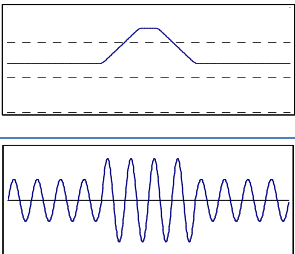
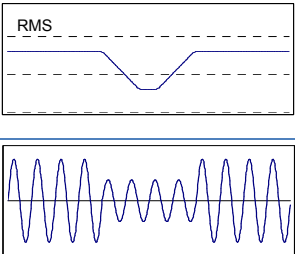
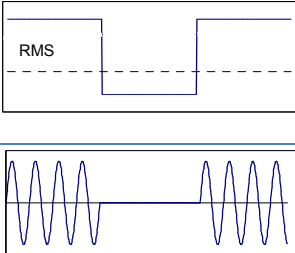
Power quality	Waveform	Symptom	Adverse effect
Harmonics		Inverter and Thyristor circuits (phase-control circuit) are used for the control circuit of general devices; these circuits affect currents and causes harmonics.	Burnout of capacitors and reactors, buzzes from transformers, malfunction of circuit breakers, flicker in screen or noises on stereos due to currents with harmonic components.
Swell		Inrush currents occur when switches for power lines are on, and then voltages increase instantaneously.	
Dip		Inrush currents occur when motor loads are activated, and dip in current occurs.	Shutdown of devices or robots or reset on PC and business machines may be caused.
INT		Power supply is interrupted for a second due to lightning strikes.	

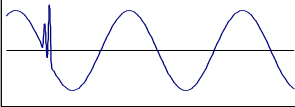
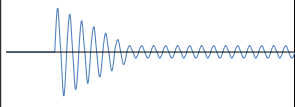
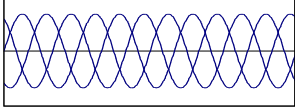
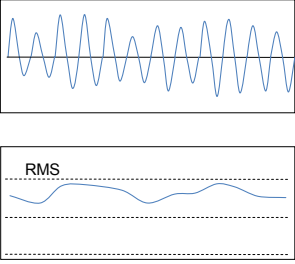
Power quality	Waveform	Symptom	Adverse effect
<p>Transient, Over-voltage (impulse)</p>		<p>Contact failure at a circuit breaker, magnet or relay.</p>	<p>Damage to a power source or reset of the device may occur due to a drastic voltage fluctuation (spike).</p>
<p>Inrush current</p>		<p>Instantaneous large currents (surge) flow on devices with a motor, incandescent lamp and flat capacitor when powering them on.</p>	<p>Influences on welded contacts for Power switch, blowing fuse, trip on breaker, rectifier circuit and fluctuations in power supply voltage may occur.</p>
<p>Unbalance rate</p>		<p>Heavy loading on specific phase due to fluctuations in load of power line or drastic extension of installations. Distortions of voltage / current waveforms, dip and negative sequence voltages are caused.</p>	<p>Influences on voltage, current, motor operation occur; negative sequence voltage and harmonics occur.</p>
<p>Flicker</p>		<p>Too much load is caused on certain phases due to increase and decrease of the loads connected to each phase such as supply lines or heavy use of specific equipments, as a result, distortions on voltage and current waveforms, dip and reversed voltages are observed.</p>	<p>Unbalanced or reversed voltages and harmonics occur and result in motor instability, trip of 3E circuit breaker or heating due to overload.</p>

Displaying recorded events

Press the **F1** (Event) Key to display the list of the recorded events.

Measured values

Symbol indicating event type

Measured values	Occurrence
102.0 V	2013/12/23 13:55:41.217
-257 V	2013/12/23 13:55:38.647
119.3 V	2013/12/23 13:55:25.727
119.3 V	2013/12/23 13:55:25.727
-285 V	2013/12/23 13:55:25.647
75.0 V	2013/12/23 13:55:12.105
451.7 A	2013/12/23 13:54:55.597
501.9 A	2013/12/23 13:54:49.097

Flicker Detection

Items and symbols displayed on the LCD

Symbol	Start	End
Swell		
Dip		
INT		
Transient		
Inrush current		
Measured value	Instantaneous values recorded at the detection of the start and end of the event. If the occurred event terminates in quite short period, the value measured at the end of the event may not be displayed. To check the r.m.s. values recorded before/ after the detection, please check r.m.s. variation data. Interval measurement data will be helpful to check the measured values of long lasting events. To record power quality events, short interval is useful in analysis.	
Occurred time and date	Time and date when KEW6315 detect the start and end of the event.	

Event detection on poly-phase systems.

"INT"

When INT states are detected on all the chs selected according to the wiring configuration, it is regarded as the start of the event. When the INT state ends on any of the measurement chs, it is regarded as the end of the event.

"Swell"/ "Dip"/ "Inrush current"/ "Transient"

When voltage or current falls into any event states on any one of the measurement chs selected according to the wiring system, it will be regarded as the start of the event. When the state ends on all measurement chs, it is regarded as the end of the event.

Measurement of Swell/ Dip/ INT/ Inrush current

Each event will be detected with the r.m.s. values in one gapless waveform and with a half-wave overlapping. The beginning of the waveform where the first event is detected is regarded as the start of the event. If further events are not detected in the following waveform, the beginning of the waveform is regarded as the end of the event. The detected event is assumed to be continued between the start to the end of event detection.

Example of Dip detection

* INT is detected in the same method.

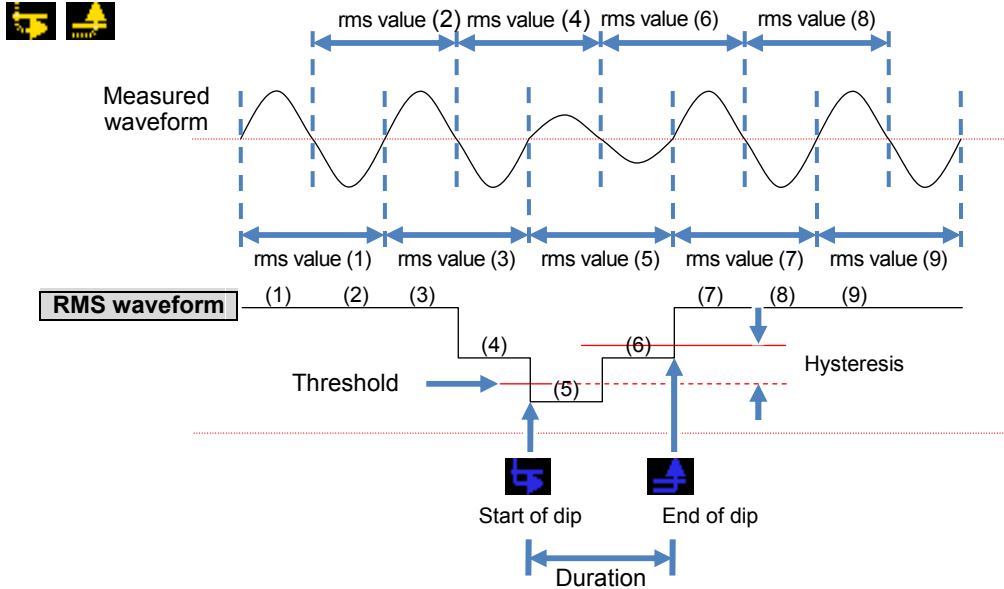

Example of Swell detection

* Inrush current is detected in the same method.

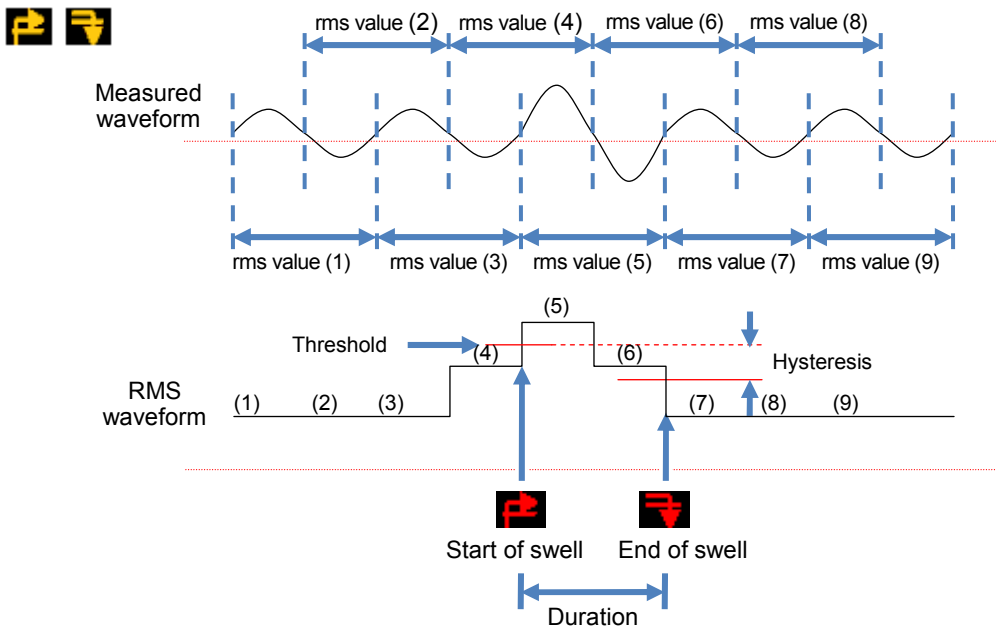

Detection of Transient

Voltage waveforms will be monitored at approx 40ksps, gapless, to calculate and check for transient event every 200ms. The beginning of the 200ms period where the first transient is detected is regarded as the start of the event. If further events are not detected in the following 200ms period, the beginning of the period is regarded as the end of the event. The detected transient is assumed to be continued between the start to the end of event detection.

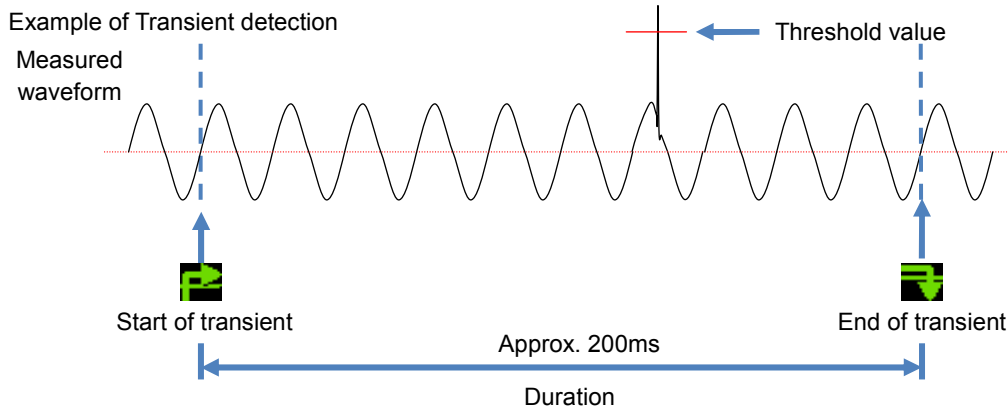

Save data

When an event occurs, event type, time of start/ end and measured values will be recorded together with the following data.

Event waveform

Waveforms and also event data on all the chs are recorded for approx. 200ms (50Hz: 10-cycle, 60Hz: 12-cycle) at 8192 points in total. When different events occur within 1 sec, only the waveforms which contain the highest-priority events will be recorded. However, if the same type of events occur at the same time, the one containing the highest (deepest) values will be recorded. If the highest (deepest) values are also the same, the one with a longer duration will be recorded. As for the channels, there is no priority order.

[Priority order]: Voltage transient -> INT -> Dip -> Swell -> Inrush current

RMS variations

Voltage/ current rms value variations and event data on all chs are recorded for 1 sec.

Example of Dip detection for approx. 800ms (saved data)

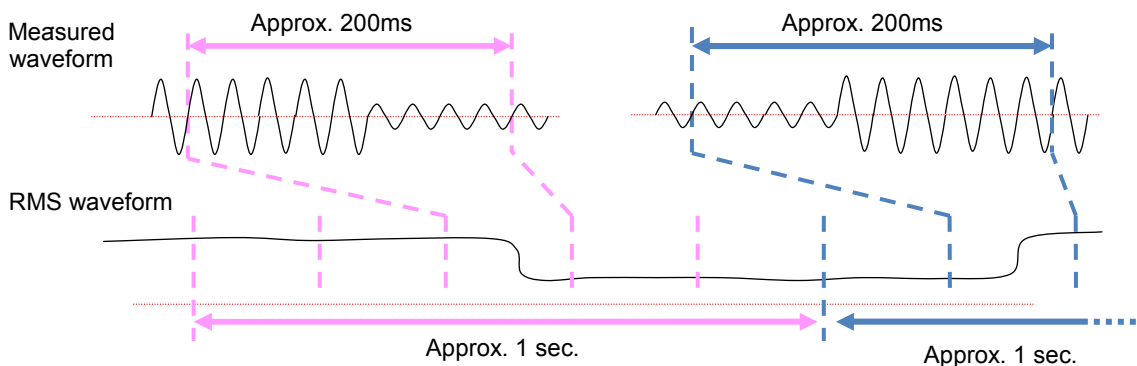

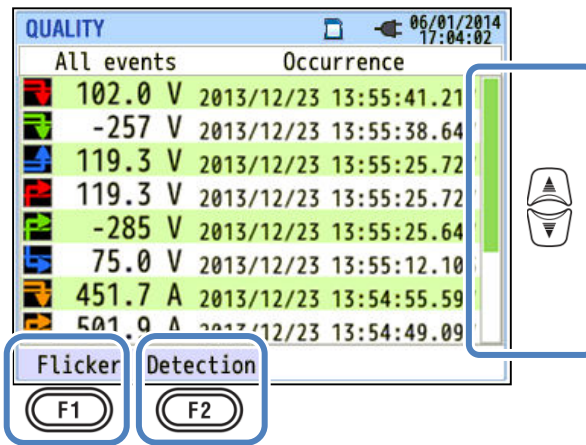

”Change the displayed area”



Press the  Key to scroll the page vertically.

”Flicker”



Press the  (Flicker) Key to display the recorded flicker values. Details are described in

”*Displaying measured flicker values in list form*” (P. 120).

”Event detection”



Press the  (Detection) Key and toggle the displayed type of event.

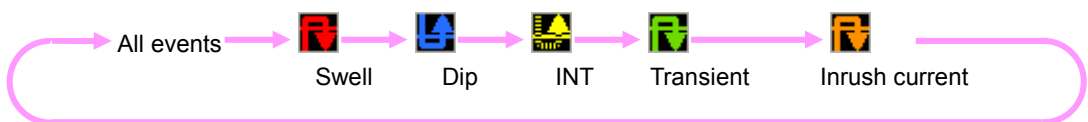

Displaying measured flicker values in list form

Press the  (Flicker) Key.

→ Press the  Key to change the displays: V: List display/ Pst(1min): Trend graph/

Plt: Transitional change.

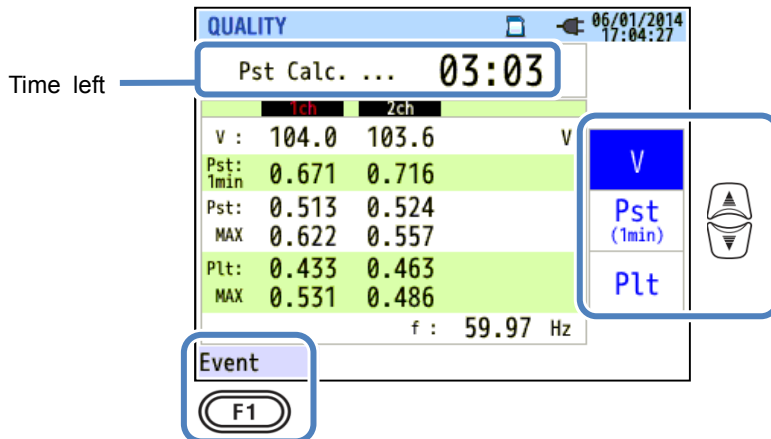

If variable loads, such as arc furnace, are connected, voltages may vary and cause changes in illumination levels. Such phenomenon is called as “voltage flicker” and its severity level is indicated by “Pst” and “Plt”.

Items displayed on the LCD	
Time left	Counted down time until a Pst calculation completes. Usually it takes about 10 min.
V	Phase voltage * For 3P3W and 3P3W3A, rms line voltages are displayed.
f	Frequency
Pst,1min	Severity of short term (1 min) flicker. It is useful for power quality survey or study.
Pst	Severity of short term (10 min) flicker.
Pst,MAX	Max Pst recorded through the beginning to the end of measurement. It is refreshed every time when the measured values exceed the previous max values.
Plt	Severity of long term (2 hours) flicker.
Plt,MAX	Max Plt recorded through the beginning to the end of measurement. It is refreshed every time when the measured values exceed the previous max values.

”Event”

Press the  (Event) Key to display the recorded events. Please refer to “**Displaying recorded events**” (P. 116) in this manual.

Displaying trend graph of Pst, 1min

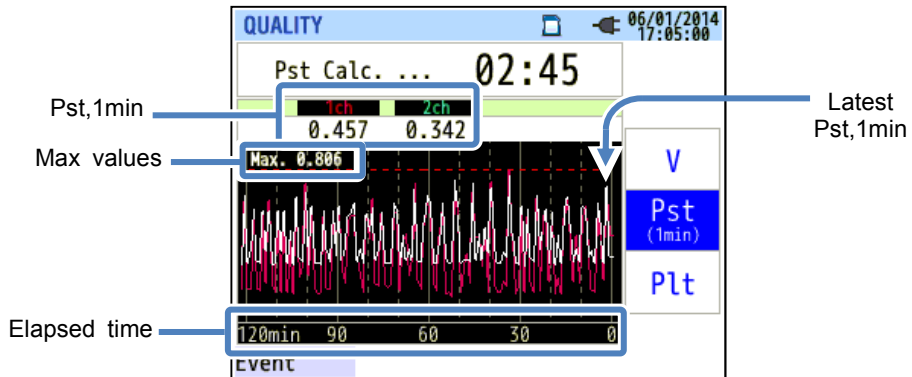

The “Pst, 1min” measured in the recent 120 min is displayed on the trend graph.

Items displayed on the LCD	
Pst,1min	The latest Pst (1 min)
Max value	Max “Pst, 1min” recorded through the measurement. It is refreshed every time when the measured values exceed the previous max values.
Elapsed time	The latest measured value is displayed at the right end (on 0 min tick), and it shifts to left as time goes by. Changes in the recent 120 min can be displayed on one screen.

Displaying changes of Plt

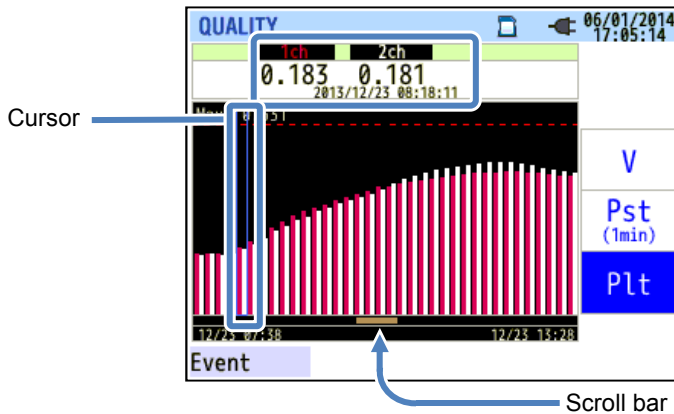

Press the  Key to move the cursor or to scroll the page to right and left. The black bar shows the percentage of hidden pages and the dark orange bar shows the percentage of the present displayed page.

Items displayed on the LCD	
Measured Plt / Recorded date	Plt per ch is displayed with recorded date & time info where the cursor is located.

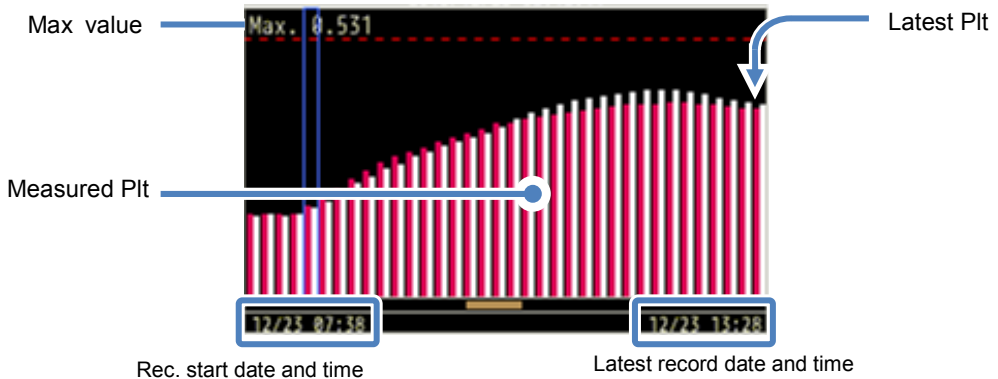

The rec. start date and time is displayed when changes of Plt cannot be described on one page.

Items displayed on the LCD	
Max value	Max Plt recorded from the beginning of the record until now. It is refreshed every time when the measured values exceed the previous max values.

Chap. 7 Other functions

“Data hold”

Display update can be disabled by pressing the “DATA HOLD” Key. The “” icon will appear while display update is disabled. The icon will disappear and display update will be enabled by pressing the “DATA HOLD” Key again. Switching screens is possible, moreover, measured values and event information are continuously recorded even while the Data hold function is activated.

“Key lock”

Pressing the “DATA HOLD” Key 2 sec or more disables all Keys, except for LCD key, and “” icon appears. Another long press (2 sec or more) is required to restore the disabled Keys.

“Turning off the Backlight”

Press the LCD Key to turn off the backlight. Pressing any keys, except for the Power key, turns on the backlight again.

“Backlight Auto-off”

While KEW6315 is connected to an AC power source:

The LCD backlight is turned off automatically 5 min after the last key operation. Press any key except for the Power key to turn on the light again. To disable the Backlight auto-off function, select “Disable auto-off” on the setup menu.

While KEW6315 operates with battery:

The brightness will be cut by half. The backlight will be automatically turned off 2min after it is turned on. Press any key except for the Power Key to turn on the backlight again. The backlight does not on continuously while the instrument is operating with batteries.

“Auto-power-off”

While KEW6315 is connected to an AC power source:

The instrument is powered off automatically 5 min after the last key operation. This function does not operate while the instrument is recording data. Press the Power key to power on the instrument again. To disable the auto-power-off function, select “Disable auto-off” on the setup menu.

While KEW6315 operates with battery:

The instrument is powered off automatically 5 min after the last key operation. This function does not operate while the instrument is recording data. Press the Power key to power on the instrument again.

“Auto-ranging” (Current range)

Current ranges of each sensor are automatically switched according to the measured rms currents. This function does not work while recording the power quality events. A range shifts to one upper range when the input exceeds 300%peak of each range and shifts to one lower range when the input drops under 100%peak of each range. However, while “AUTO” is selected, the upper range will be adopted to display the values.

“Sensor detection”

Press the “Detection” key on the SETUP menu to detect the connected clamp sensors. KEW6315 automatically detects the connected sensors and checks the settings of the sensors.

“Recovery from power fails”

When the power supply to the instrument is inadvertently lost during a record, the interrupted record will be resumed after the power supply is restored.

“Print screen”

Press the “PRINT SCREEN” Key to save the displayed screen as a BMP (bitmap) file.

* Max file size: approx. 77KB

“Retain settings”

Settings used during the previous test will not be cleared after powering off the instrument. KEW6315 retains and adopts the previous settings. * Default values will be displayed for the first time after purchase.

”Quick start guide”

Press the “START/STOP” Key to run the “Quick start guide”. It is useful to start recording just by adjusting some simple settings according to the displayed screens.

”Status indicator”

The red indicator LED blinks when the backlight is off, and the green indicator LED stays on during recording regardless of the backlight states. The green indicator LED blinks during stand-by mode.

Chap. 8 Device connection

8.1 Data transfer to PC

Data in the SD card or the internal memory can be transferred to PC via USB or SD card reader.

	Transfer to PC via:	
	USB ^{*1}	Card reader
SD card data (file)	Δ	○
Internal memory data (file)	○	-----

^{*1}: It is recommended to transfer the large data by use of SD card since transferring large data files by USB requires more time than using the SD card reader. (transfer time : approx 320MB/ hour)
As to the manipulation of SD cards, please refer to the instruction manual attached to the card.
In order to save data without any problem, make sure to delete the files other than the data measured with this instrument from the SD card beforehand.

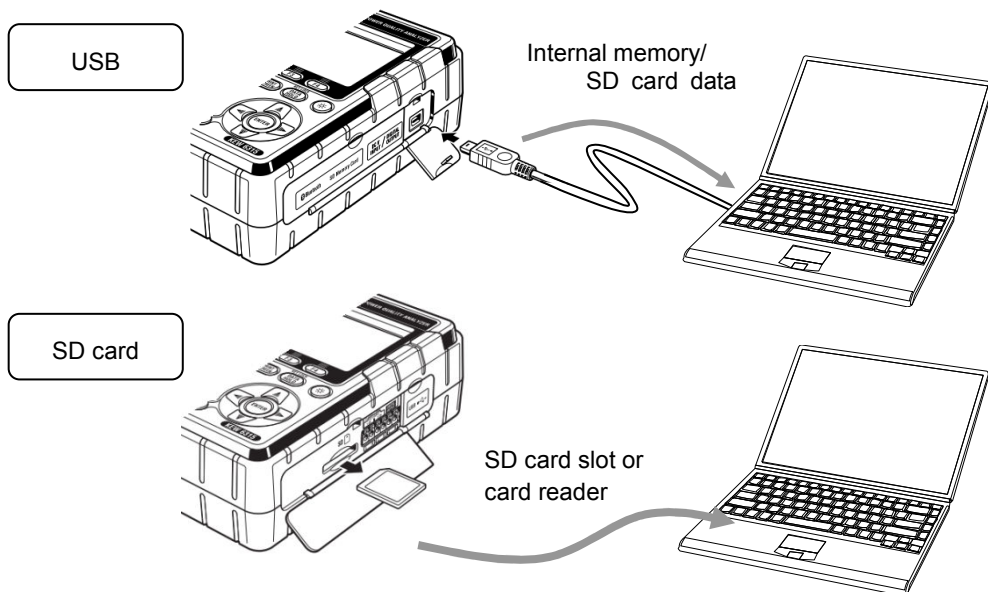

8.2 Using Bluetooth® function

Measuring data can be checked on android devices in real-time via Bluetooth® communication. It is necessary to enable Bluetooth® function prior to using Bluetooth® communication. (Setting No. 26: Bluetooth)

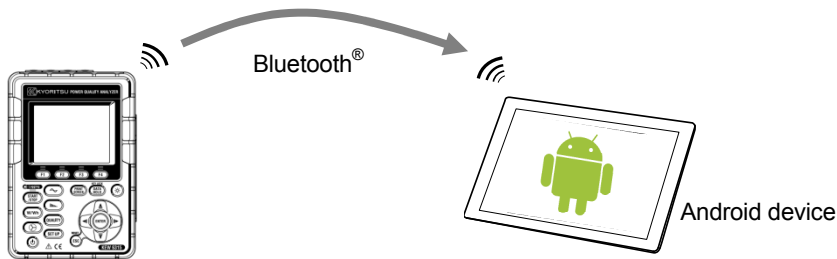

* Before starting to use this function, download the special application “KEW Smart” from the Internet site. The application “KEW Smart” is available on the download site for free. (Internet access is required and charges may be incurred.)

* “Bluetooth®” is a registered trademark of Bluetooth SIG.

8.3 Signal control

Connection to input/ output terminals

⚠ CAUTION

- Voltages applied to the terminals should not exceed the following ranges.
 - * for input terminals: within $\pm 11\text{V}$, for output terminals: between 0 and 30V(50mA, 200mW)
 Otherwise, the instrument may be damaged.
- The root of each L-terminal is the same. Do not connect different ground levels of multiple inputs at the same time. Roots of the L terminals for each Ch are integrated. Never connect inputs with various ground levels to the terminal at the same time.

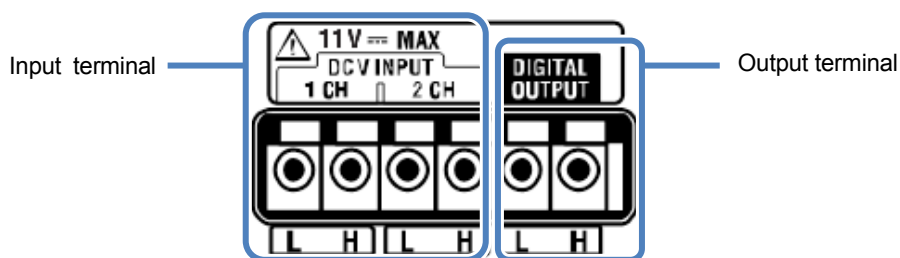

Ensure that the wires are connected to proper terminals.

Wires of following dimensions can be used.

Suitable wire : single-wire $\Phi 1.2$ (AWG16), twisted wire 1.25mm² (AWG16),
strand size $\Phi 0.18\text{mm}$ or more

Usable wire : single-wire $\Phi 0.4 - 1.2$ (AWG26 - 16), twisted wire 0.2 - 1.25mm² (AWG24 - 16),
strand size $\Phi 0.18\text{mm}$ or more

Standard length of bare wire: 11mm

- 1 Open the Connector cover.
- 2 Press the rectangular protrusion above a terminal with a flat-blade screw driver, and insert a signal wire.
- 3 Remove the driver and fix the wire.

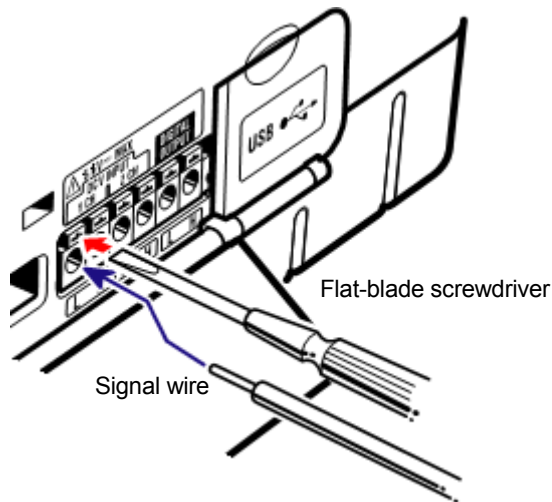

”Input terminal”

For monitoring the voltage output signals of Thermo sensors. These terminals are useful to measure the signals from other devices and power failures at the same time.

Number of Ch: 2ch

Input resistance : approx 225.6kΩ

”Output terminal”

For fixing the generating outputs to “Low” while power quality events are lasting. Usually, it is fixed to “High”, but changed to “Low” if the duration of an event is less than 1 sec. This is applicable to the events with the highest-priority only. To adjust the generating outputs to the events with low-priority, select “OFF” for the events with higher priority than the desired event. The details are described in “**Threshold setting for Power quality (Event)**” (P. 65). * [Priority order]: Transient -> INT -> Dip -> Swell -> Inrush current

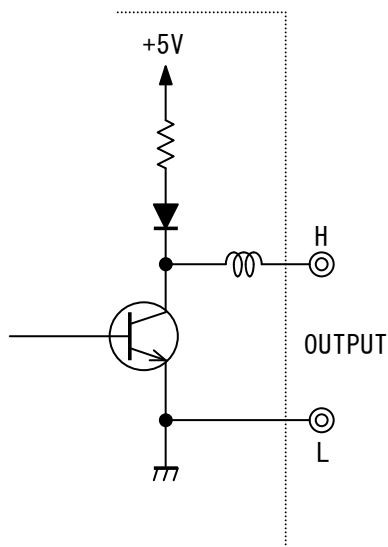

Output format : Open collector output

Max input : 30V, 50mA, 200mW

Output voltage : Hi – 4 to 5V

Lo – 0 to 1V

8.4 Getting power from measured lines

If it is difficult to get power from an outlet, KEW6315 operates with power from the measured line by using Power supply adapter MODEL8312 and voltage test leads.

DANGER

- When the instrument and the test lead are combined and used together, whichever lower category either of them belongs to will be applied. Confirm that the measured voltage rating of the test lead is not exceeded.
- Do not connect a Voltage test lead unless required for measuring the desired parameters.
- Connect Voltage test leads to the instrument first, and only then connect them to the measured line.
- Never disconnect the voltage test leads from the connectors of the instrument during a measurement (while the instrument is energized).
- Connect to the downstream side of a circuit breaker since a current capacity at the upstream side is large.

WARNING

- Power off the instrument before connecting the adapter and test leads.
- Connect Voltage test lead to the instrument first. It should be firmly connected.
- Never attempt to make measurement if any abnormal conditions are noted, such as a broken cover and exposed metal parts.

Connect the Adapter according to the following procedure.

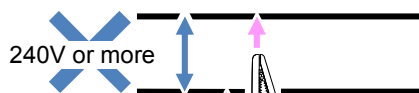

- 1 Confirm that the Power switch on MODEL8312 is "OFF".
- 2 Connect the Plug of MODEL8312 to VN and V1 terminals on KEW6315.
- 3 Connect the Power Plug of MODEL8312 to the Power connector On KEW6315.
- 4 Connect the Voltage test leads to VN and V1 terminals of the Adapter.
- 5 Connect the Alligator clips of the voltage test leads to the circuit under test.
- 6 Power on MODEL8312.
- 7 Start KEW6315.

* Reversed procedure is applied to remove the Adapter from KEW6315.

Please refer to the instruction manual for MODEL8312 for further details.

MODEL8312
Measurement CAT.III 150V CAT.II 240V
Fuse rating : AC500mA/ 600V,
Fast acting, $\Phi 6.3 \times 32\text{mm}$

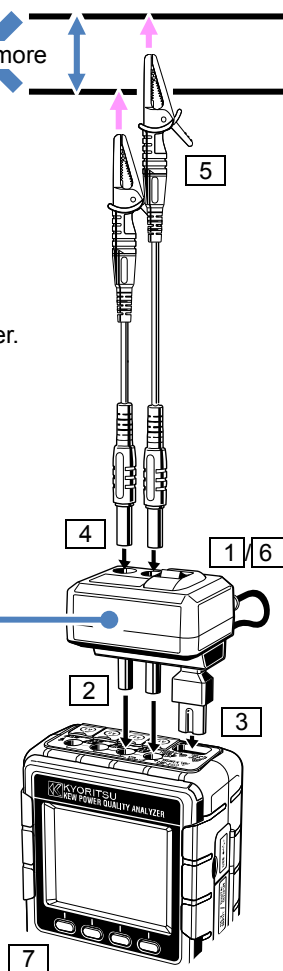

Chap. 9 PC software for setting and data analysis

The special software “KEW Windows for KEW6315” for data analysis and for making KEW6315 settings is available. * Automatic creation of graph and list from recorded data. Uniform management of setting and recorded data acquired from multiple devices. Data can be expressed in crude oil and CO2 equivalent values in the report.

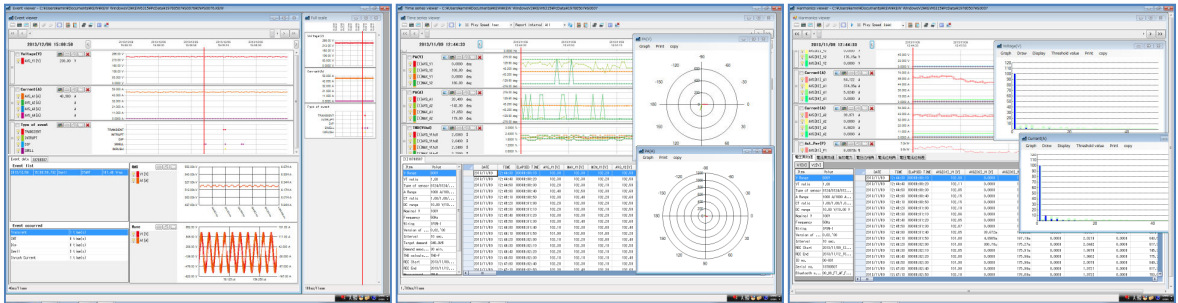

Please refer to the installation manual for “KEW Windows for KEW6315” and install the application and USB driver in your PC.

● Interface

This instrument is equipped with USB and Bluetooth® interfaces.

Communication method : USB Ver2.0

Bluetooth® : Bluetooth® Ver2.1+EDR (Class2)

Compliant profile: SPP

The following can be done by USB/ Bluetooth® communication.

- * Downloading files in the internal memory of the instrument to a PC
- * Making settings for the instrument via a PC
- * Displaying the measured results on a PC as graphs in real-time and also saving the measured data at the same time

● System Requirements

- * OS (Operation System)
Windows® 8/ 7/ Vista/ XP
- * Display
1024 × 768 dots, 65536 colors or more
- * HDD (Hard-disk space required)
1Gbyte or more (including Framework)
- * .NET Framework (3.5 or more)

● Trademark

- * Windows® is a registered trademark of Microsoft in the United States.
- * Bluetooth® is a registered trademark of Bluetooth SIG.



The latest software is available for download from our homepage.

<http://www.kew-ltd.co.jp>

Chap. 10 Specification

10.1 Safety requirements

Location for use	: In door use, Altitude up to 2000m
Temperature & humidity range	: 23°C±5°C, Relative humidity 85% or less (no condensation) (guaranteed accuracy)
Operating Temperature & humidity range	: 0°C to 45°C, Relative humidity 85% or less (no condensation)
Storage Temperature & humidity range	: -20°C to 60°C, Relative humidity 85% or less (no condensation)
Withstand voltage	
AC5160V/ for 5 sec.	Between (AC Voltage input terminal) and (Enclosure)
AC3310V/ for 5 sec.	Between (AC Voltage input terminal) and (Current input terminal, Power connector, USB connector)
AC2210V/ for 5 sec.	Between (Power connector) and (Current input terminal, USB connector, Enclosure)
Insulation resistance	: 50MΩ or more / 1000V; Between (Voltage/Current input terminal, Power connector) and (Enclosure)
Applicable standards	: IEC 61010-1 Measurement CAT.IV 300V CAT.III 600V CAT.II 1000V Pollution degree 2, IEC 61010-031, IEC61326 Class A
Dust-/ water-proof	: IEC 60529 IP40

10.2 General specification

Measured line and Input ch : Current ch (A2-A4) unrelated to the selected wiring system can be used for any measurement purpose.

Wiring system	Input ch	
	Voltage	Current
Single-phase2-wire-1-system (1P2W-1)	VN-V1	A1
Single-phase2-wire-2-system (1P2W-2)	VN-V1	A1,A2
Single-phase2-wire-3-system (1P2W-3)	VN-V1	A1,A2,A3
Single-phase2-wire-4-system (1P2W-4)	VN-V1	A1,A2,A3,A4
Single-phase3-wire-1-system (1P3W-1)	VN-V1,V2	A1,A2
Single-phase3-wire-2-system (1P3W-2)	VN-V1,V2	A1,A2,A3,A4
Three-phase3-wire-1-system (3P3W-1)	VN-V1,V2	A1,A2
Three-phase3-wire-2-system (3P3W-2)	VN-V1,V2	A1,A2,A3,A4
Three-phase3-wire(3P3W3A)	V1-V2,V2-V3,V3-V1	A1,A2,A3
Three-phase4-wire(3P4W)	VN-V1,V2,V3	A1,A2,A3

LCD : 3.5inch, TFT, QVGA(320×RGB×240)

Display update : every 1 sec*

* There may be time lag in display update (max. 2 sec) due to arithmetic processing, however, no time lag between the recorded data and the time stamp.

Backlight (Press the LCD Key to turn off, press any key other than "Power" to turn on.)

PQ measurement : IEC 61000-4-30 Ed.2 Class S

Dimension : 175(L)×120(W)×68(D)mm

Weight : approx. 900g (including batteries)

Accessories : V test leads MODEL7255 (red, white, blue, black) with alligator clip · 1 set
 Power cord MODEL7169 1 pce
 USB cable MODEL7219 1 pce
 Quick manual 1 pce
 CD-ROM 1 pce
 PC software for setting and data and data analysis
 (KEW Windows for KEW6315)
 Instruction manual data (PDF file)
 Alkaline size AA battery (LR6) 6 pcs
 SD card M-8326-02 1 pce
 Carrying case MODEL9125 1 pce
 Input terminal plate 1 pce
 Cable marker 8-color x 4pcs each (red, blue, yellow,
 green, brown, gray, black, white)

Optional parts : Clamp sensor
 MODEL8128 (Clamp sensor 50A ø24mm)
 MODEL8127 (Clamp sensor 100A ø24mm)
 MODEL8126 (Clamp sensor 200A ø40mm)
 MODEL8125 (Clamp sensor 500A ø40mm)
 MODEL8124 (Clamp sensor 1000A ø68mm)
 MODEL8129 (Flexible sensor 3000A ø150mm)
 MODEL8130 (Flexible sensor 1000A ø110mm)
 MODEL8146 (Leakage sensor 10A ø24mm)
 MODEL8147 (Leakage sensor 10A ø40mm)
 MODEL8148 (Leakage sensor 10A ø68mm)
 MODEL8141 (Leakage sensor 1A ø24mm)
 MODEL8142 (Leakage sensor 1A ø40mm)
 MODEL8143 (Leakage sensor 1A ø68mm)
 Instruction manual for Clamp sensor
 Carrying case with magnet MODEL9132
 Power supply adapter MODEL8312 (CAT.III 150V, CAT.II 240V)

Accuracy : within ±5 sec/ day

Power source : AC power supply

Voltage range	AC100V(AC90V) - AC240V(AC264V)
Frequency	50Hz(47Hz) - 60Hz(63Hz)
Power consumption	7VAmax

: DC power supply

	Dry-cell battery	Rechargeable battery
Voltage	DC3.0V (1.5V×2 in series × 3 in parallel)	DC2.4V (1.2V×2 in series × 3 in parallel)
Battery	Size AA Alkaline (LR6)	Size AA Ni-MH (1900mA/h)
Current consumption	1.0A typ.(@3.0V)	1.1A typ.(@2.4V)
Battery life *ref. value at 23°C	3 hours: Backlight OFF	4.5 hours: Backlight OFF * with fully charged batteries

Real-time OS :

This Product uses the Source Code of T-Kernel under T-License granted by the T-Engine Forum (www.t-engine.org) Portions of this software are copyright (c) 2010 The FreeType Project (www.freetype.org). All rights reserved.

External communication function : USB * USB cable length: 2m max.

Connector	mini-B
Communication method	USB Ver2.0
USB identification no.	Vendor ID: 12EC(Hex) Product ID: 6315(Hex) Serial no.: 0+7 digit individual no.
Communication speed	12Mbps (full-speed)

: Bluetooth®

Communication method	Bluetooth®Ver2.1+EDR Class2
Profile	SPP
Frequency	2402 - 2480MHz
Modulation method	GFSK(1Mbps), $\pi/4$ -DQPSK(2Mbps), 8DPSK(3Mbps)
Transmission system	Frequency-hopping system



Digital output terminal :

Normally, it is set to "High". It changes to "Low" while the measured values are exceeding the thresholds set for each power quality event. Usually, it is fixed to "High", but changed to "Low" if the duration of an event is less than 1 sec. This is applicable to the events with the highest-priority only. To adjust the generating outputs to the events with low-priority, select "OFF" for the events with higher priority than the desired event.



* [Priority order]: Transient -> INT -> Dip -> Swell -> Inrush current

Connector	Terminal block with 6-polarity (black, red, gray ML800-S1H-6P)
Output format	Open collector output, Low active
Input voltage	0 - 30V, 50mAmax, 200mW
Output voltage	High:4.0V-5.0V, Low:0.0 - 1.0V

Data storage location : Internal FLASH memory

Storage capacity	4MB (Data storage capacity: 3,437,500byte)
Max data size	14,623byte/data (max: 234 data) *3P3W-2/1P3W-2 (Power + Harmonics)
Max number of saved file	3 * Number of times that you can start a measurement.
Icon display	When the internal memory is available, the  icon is displayed on the LCD during record.
FULL indication	The  icon blinks when saved data size or number of saved file exceeds the capacity. Data cannot be saved while this mark is being displayed. The instrument measures integration/ demand continuously, but does not record the data.

: SD card

Storage capacity	2GB (Data storage capacity: 1.86Gbyte)
Max data size (2GB)	14,623byte/data (Max:1,271,964 data) *3P3W-2/1P3W-2(Power+ Harmonics)
Max number of saved file (2GB)	65536 * Number of times that you can start a measurement.
Icon display	When the SD card is available, the  icon is displayed on the LCD.
Format (2GB)	FAT16
FULL indication	The  icon blinks when saved data size or number of saved file exceeds the capacity. Data cannot be saved while this mark is being displayed. The instrument measures integration/ demand continuously, but does not record the data.

10.3 Measurement specification

Measured items and the number of analysis points

Computed with 8192-point data while regarding 200ms(50Hz:10-cycle, 60Hz:12-cycle) as one measurement area.

Frequency, r.m.s. voltage/ current, active power, apparent power, reactive power, PF, Capacitance calc.

Computed with 2048-point data while regarding 200ms(50Hz:10-cycle, 60Hz:12-cycle) as one measurement area.

Voltage/current unbalance ratio, r.m.s. harmonics voltage/current (rate of content), harmonics reactive power, total harmonics voltage/ current distortion factor (THDV-F/R)/ (THDA-F/R), phase angle of harmonics voltage/ current, phase difference of harmonics voltage/ current

Computed with 819-point data (50Hz), 682-point data (60Hz) while regarding one waveform overlapped every half wave as one measurement area.

Voltage dip, voltage swell, INT, Inrush current

Described based on inst values measured at 40.96ksps.

Voltage/ current waveform, External input voltage

Items measured at Instantaneous measurement

Frequency f [Hz]

Displayed digit	4-digit
Accuracy	±2dgt (40.00Hz - 70.00Hz, V1 Range 10% - 110%, sine wave)
Display range	10.00 - 99.99Hz
Input source	V ₁ (fix)

10-sec average frequency f10 [Hz]

Displayed digit	4-digit * e.g. averaged frequency values at 10 sec of intervals
Meas. system	Complied with IEC61000-4-30
Accuracy	±2dgt (40.00Hz - 70.00Hz, V1 Range 10% - 110%, sine wave)
Display range	10.00 - 99.99Hz
Input source	V ₁ (fix)

R.M.S. Voltage V [Vrms]

Range	600.0/1000V
Displayed digit	4-digit
Effective input range	1% - 120% of Range (rms) and 200% of Range (peak)
Display range	0.15% - 130% of Range ("0" is displayed at less than 0.15%)
Crest factor	3 or less
Meas. system	Complied with IEC61000-4-30
Accuracy	Assuming that measuring 40-70Hz, sine wave at 600V Range: 10% - 150% against 100V or more of nominal V :Nominal V±0.5% Out of above range and at 1000V Range :±0.2%rdg±0.2%f.s.
Input impedance	approx 1.67MΩ
Equation	$V_c = \sqrt{\left(\frac{1}{n} \left(\sum_{i=0}^{n-1} (V_{ci})^2\right)\right)}$ <p>i : sampling point* n: number of sampled values at 10 or 12-cycle c : Measurement channel</p> <p>* 50Hz: 8192 points in 10 waveforms, 60Hz: 8192 points in 12 waveforms</p>
1P2W-1 to 4	V ₁
1P3W-1 to 2	V ₁ , V ₂
3P3W-1 to 2	Line voltage: V ₁₂ , V ₂₃ , V ₃₁ = $\sqrt{(V_{23}^2 + V_{12}^2 + 2 \times V_{23} \times V_{12} \times \cos\theta V)}$ *θV=relative angles of V ₁₂ , V ₂₃
3P3W3A	Line voltage: V ₁₂ , V ₂₃ , V ₃₁
3P4W	Phase voltage: V ₁ , V ₂ , V ₃ Line voltage : V ₁₂ = $\sqrt{(V_1^2 + V_2^2 - 2 \times V_1 \times V_2 \times \cos\theta V_1)}$ V ₂₃ = $\sqrt{(V_2^2 + V_3^2 - 2 \times V_2 \times V_3 \times \cos\theta V_2)}$ V ₃₁ = $\sqrt{(V_3^2 + V_1^2 - 2 \times V_3 \times V_1 \times \cos\theta V_3)}$ * θV ₁ = relative angles of V ₁ , V ₂ , θV ₂ = relative angles of V ₂ , V ₃ , θV ₁ = relative angles of V ₃ , V ₁

R.M.S. Current A [Arms]

Range	MODEL8128 (50A) :5000m/50.00A/AUTO MODEL8127 (100A) :10.00/100.0A/AUTO MODEL8126 (200A) :20.00/200.0A/AUTO MODEL8125 (500A) :50.00/500.0A/AUTO MODEL8124/30 (1000A) :100.0/1000A/AUTO MODEL8141/8142/8143 (1A) :500.0mA MODEL8146/8147/8148 (10A) :1000m/10.00A/AUTO MODEL8129 (3000A) :300.0/1000/3000A
Displayed digit	4-digit
Effective input range	1% - 110% of each Range (rms) and 200% of Range (peak)
Display area	0.15% - 130% of each range ("0" is displayed at less than 0.15%)
Crest factor	3 or less
Meas. system	Complied with IEC61000-4-30
Accuracy	Assuming that measuring 40-70Hz, sine wave: $\pm 0.2\% \text{rdg} \pm 0.2\% \text{f.s.} +$ accuracy of clamp sensor
Input impedance	approx 100k Ω
Equation	$A_c = \sqrt{\left(\frac{1}{n} \left(\sum_{i=0}^{n-1} (A_{ci})^2 \right) \right)}$ <p>c : Measurement channel A_1, A_2, A_3, A_4 i : sampling point* n: number of sampled values at 10 or 12-cycle</p> <p>* 50Hz: 8192 points in 10 waveforms, 60Hz: 8192 points in 12 waveforms * A_3 value for 3P3W-1 to 2 is calculated with r.m.s. current values. $A_3 = \sqrt{(A_1^2 + A_2^2 + 2 \times A_1 \times A_2 \times \cos\theta A)}$ relative angles of $\theta A = A_1, A_2$</p>

Active power P [W]

Range						
Current Voltage	8128		8127		8126	
	50.00A	5000mA	100.0A	10.00A	200.0A	20.00A
1000V	50.00k	5000	100.0k	10.00k	200.0k	20.00k
600.0V	30.00k	3000	60.00k	6000	120.0k	12.00k
Current Voltage	8125		8124/30		8146/47/48	
	500.0A	50.00A	1000A	100.0A	10.00A	1000mA
1000V	500.0k	50.00k	1000k	100.0k	10.00k	1000
600.0V	300.0k	30.00k	600.0k	60.00k	6000	600.0
Current Voltage	8141/42/43	8129				
	500.0mA	3000A	1000A	300.0A		
1000V	500.0	3000k	1000k	300.0k		
600.0V	300.0	1800k	600.0k	180.0k		
Displayed digit	4-digit					
Accuracy	±0.3%rdg±0.2%f.s.+ accuracy of clamp sensor (PF 1, sine wave, 40-70Hz) *Sum values are total amounts of the used channels.					
Influence of PF	±1.0%rdg (40Hz-70Hz, PF0.5)					
Polarity	Consumption (flow-in):+(no sign), Regenerating(flow-out):-					
Formula	$P_c = \frac{1}{n} \left(\sum_{i=0}^{n-1} (V_{ci} \times A_{ci}) \right)$ <p>c: Measurement channel i: sampling point* n: number of sampled values</p> <p>* 50Hz: 8192 points in 10 waveforms, 60Hz: 8192 points in 12 waveforms</p>					
1P2W-1 to 4	$P_1, P_2, P_3, P_4, P_{sum}=P_1+P_2+P_3+P_4$					
1P3W(3P3W)-1 to 2	$P_1, P_2, P_{sum1}=P_1+P_2$ $P_3, P_4, P_{sum2}=P_3+P_4$ $P_{sum}=P_{sum1}+P_{sum2}$					
3P3W3A	$P_1, P_2, P_3, P_{sum}=P_1+P_2+P_3$ * Phase voltages are used.					
3P4W	$P_1, P_2, P_3, P_{sum}=P_1+P_2+P_3$					

External input voltage DCi [V]

Range	100.0mV/ 1000mV/ 10.00V
Displayed digit	4-digit
Effective input range	1% - ±100% (DC) of each Range
Display range	0.3% - ±110% of each Range ("0" is displayed at less than 0.3%)
Accuracy	±0.5%f.s (DC)
Input impedance	Approx. 225.6kΩ
Saved item	External input voltage

Items to be calculated

Apparent power S [VA]

Range	Same as active power.
Displayed digit	Same as active power.
Accuracy	±1dgt against each calculated value (for sum : ±3dgt)
Sign	No polarity indication
Equation	$S_c = V_c \times A_c$; when $P_c > S_c$, regarding $P_c = S_c$. c: Measurement channel
1P2W-1 to 4	$S_1, S_2, S_3, S_4, S_{sum} = S_1 + S_2 + S_3 + S_4$
1P3W-1 to 2	$S_1, S_2, S_{sum1} = S_1 + S_2$
	$S_3, S_4, S_{sum2} = S_3 + S_4$
	$S_{sum} = S_{sum1} + S_{sum2}$
3P3W-2	$S_1, S_2, S_{sum1} = \sqrt{3/2}(S_1 + S_2)$
	$S_3, S_4, S_{sum2} = \sqrt{3/2}(S_3 + S_4)$
	$S_{sum} = S_{sum1} + S_{sum2}$
3P3W3A	$S_1, S_2, S_3, S_{sum} = S_1 + S_2 + S_3$ * Phase angles are used.
3P4W	$S_1, S_2, S_3, S_{sum} = S_1 + S_2 + S_3$

Reactive power Q [Var]

Range	Same as active power.
Displayed digit	Same as active power.
Accuracy	±1dgt against each calculated value (for sum : ±3dgt)
Sign	<p>– : leading phase (current phase against voltage)</p> <p>+ (no sign) : lagging phase (current phase against voltage)</p> <p>Harmonics reactive power is calculated per ch, and the polarity sign of the reversed basic waveform is displayed.</p>
Equation	$Q_c = sign \sqrt{S_c^2 - P_c^2}$ sign: Polarity sign, c: Measurement channel
1P2W-1 to 4	$Q_1, Q_2, Q_3, Q_4, Q_{sum} = Q_1 + Q_2 + Q_3 + Q_4$
1P3W(3P3W)-1 to 2	$Q_1, Q_2, Q_{sum1} = Q_1 + Q_2$
	$Q_3, Q_4, Q_{sum2} = Q_3 + Q_4$
	$Q_{sum} = Q_{sum1} + Q_{sum2}$
3P3W3A(3P4W)	$Q_1, Q_2, Q_3, Q_{sum} = Q_1 + Q_2 + Q_3$

Power factor: PF

Display range	-1.000 to 0.000 to 1.000
Accuracy	±1dgt against each calculated value (for sum : ±3dgt)
Sign	– : leading phase + (no sign) : lagging phase Harmonics reactive power is calculated per ch, and the polarity sign of the reversed basic waveform is displayed.
Equation	$PF_c = sign \left \frac{P_c}{S_c} \right $ sign: Polarity mark, c: Measurement channel
1P2W-1 to 4	$PF_1, PF_2, PF_3, PF_4, PF_{sum}$
1P3W(3P3W)-1 to 2	PF_1, PF_2, PF_{sum1} PF_3, PF_4, PF_{sum2} PF_{sum}
3P3W3A(3P4W)	$PF_1, PF_2, PF_3, PF_{sum}$

Neutral current An [A] * only when the wiring configuration is 3P4W.

Range	Same as r.m.s. current.
Displayed digit	Same as r.m.s. current.
Display area	Same as r.m.s. current.
Equation	$An = \sqrt{\{A1 + A2 \cos(\theta2 - \theta1) + A3 \cos(\theta3 - \theta1)\}^2 + \{A2 \sin(\theta2 - \theta1) + A3 \sin(\theta3 - \theta1)\}^2}$ * $\theta1, 2, 3$ represent the phase differences between $V1$ and $A1, 2$ and 3 respectively.

Voltage unbalance ratio Uunb [%]

Displayed digit	5-digit
Display range	0.00% to 100.00%
Wiring	3P3W, 3P4W
Meas. system	Complied with IEC61000-4-30
Accuracy	±0.3%: at 50/60Hz, sine wave (between 0 to 5 % according to IEC61000-4-30)
Equation	$V_{umb} = \sqrt{\left(\frac{1 - \sqrt{3 - 6\beta}}{1 + \sqrt{3 - 6\beta}} \right)} \times 100 \quad \beta = \frac{V_{12}^4 + V_{23}^4 + V_{31}^4}{(V_{12}^2 + V_{23}^2 + V_{31}^2)^2}$ * The 1st order components of harmonic voltage are used. * For 3P4W system, phase voltages are converted to line voltages for calculation. $V_{12} = V_1 - V_2, V_{23} = V_2 - V_3, V_{31} = V_3 - V_1$

Current unbalance ratio Aunb [%]

Displayed digit	5-digit
Display range	0.00% to100.00%
Wiring	3P3W, 3P4W
Equation	$I_{umb} = \sqrt{\left(\frac{1 - \sqrt{(3 - 6\beta)}}{1 + \sqrt{(3 - 6\beta)}}\right)} \times 100 \quad \beta = \frac{A_{12}^4 + A_{23}^4 + A_{31}^4}{(A_{12}^2 + A_{23}^2 + A_{31}^2)^2}$ <p>* The 1st order components of harmonic current are used.</p> <p>* For 3P4W system, phase voltages are converted to line voltages for calculation.</p> <p>$A_{12} = A_1 - A_2, A_{23} = A_2 - A_3, A_{31} = A_3 - A_1$</p>

Capacitance calculation

Displayed digit	4-digit, Unit: nF, μF, mF, kvar
Display range	0.000nF - 9999F, 0.000kvar - 9999kvar
Equation	$C_c = P_c \times \left(\sqrt{\frac{1}{PF_c^2} - 1} - \sqrt{\frac{1}{PF_{c_Target}^2} - 1} \right) [k \text{ var}]$ $= \frac{P_c \times 10^9}{2\pi f \times V_c^2} \times \left(\sqrt{\frac{1}{PF_c^2} - 1} - \sqrt{\frac{1}{PF_{c_Target}^2} - 1} \right) [\mu F]$ <p>C_c : Capacitance needs for improvement P_c : Load power (active power) [kW] f : Frequency V_c : R.m.s. voltage PF_c : Measured PF PF_{c_Target} : New power factor (target) c : Measurement channel</p>
1P2W-1 to 4	$C_1, C_2, C_3, C_4, C_{sum} = C_1 + C_2 + C_3 + C_4$
1P3W(3P3W)-1 to 2	$C_1, C_2, C_{sum1} = C_1 + C_2$
	$C_1, C_2, C_{sum2} = C_3 + C_4$
	$C_{sum} = C_{sum1} + C_{sum2}$
3P3W/3A(3P4W)	$C_1, C_2, C_3, C_{sum} = C_1 + C_2 + C_3$

Items measured at Integration measurement

Power consumption (if $P \geq 0$)

Active power energy $+WP$ [Wh]

Displayed digit	6-digit, Unit: m, k, M, G, T (harmonized with $+WS$)
Display area	0.00000mWh - 9999.99TWh (harmonized with $+WS$) * "OL" is displayed when the display area is exceeded.
Equation	$+WP_c = \frac{1}{h} \left(\sum_i (+P_{ci}) \right)$ <p>h: integration period (3600 sec), c: Measurement channel, i: Data point no.</p>
1P2W-1 to 4	$+WP_1, +WP_2, +WP_3, +WP_4, +WP_{sum}$
1P3W(3P3W)-1	$+WP_1, +WP_2, +WP_{sum1}$
to 2	$+WP_3, +WP_4, +WP_{sum2}$ $+WP_{sum}$
3P3W3A(3P4W)	$+WP_1, +WP_2, +WP_3, +WP_{sum}$

Apparent power energy $+WS$ [VAh]

Displayed digit	6-digit, Unit: m, k, M, G, T (harmonized with $+WS$)
Display area	0.00000mVAh - 9999.99TVAh (harmonized with $+WS$) * "OL" is displayed when the display area is exceeded.
Equation	$+WS_c = \frac{1}{h} \left(\sum_i (S_{ci}) \right)$ <p>h: integration period (3600 sec), c: Measurement channel, i: Data point no.</p>
1P2W-1 to 4	$+WS_1, +WS_2, +WS_3, +WS_4, +WS_{sum}$
1P3W(3P3W)-1	$+WS_1, +WS_2, +WS_{sum1}$
2	$+WS_3, +WS_4, +WS_{sum2}$ $+WS_{sum}$
3P3W3A(3P4W)	$+WS_1, +WS_2, +WS_3, +WS_{sum}$
Saved item	Apparent power energy

Reactive power energy +WQ [Varh]

Displayed digit	6-digit, Unit: m, k, M, G, T (harmonized with +WS)
Display area	0.00000mvarh - 9999.99Tvarh (harmonized with +WS) * "OL" is displayed when the display area is exceeded.
Equation	<p>Leading phase $+WQc_c = \frac{1}{h} \left(\sum_i (+Q_{ci}) \right)$,</p> <p>Lagging phase $+WQi_c = \frac{1}{h} \left(\sum_i (-Q_{ci}) \right)$,</p> <p>h: integration period (3600 sec), n: System No., c: Measurement channel, i: Data point no. * where: Lagging phase: $Q \geq 0$, Leading phase: $Q < 0$</p>
1P2W-1 to 4	$+WQ_1, +WQ_2, +WQ_3, +WQ_4, +WQ_{sum}$
1P3W(3P3W)-1	$+WQ_1, +WQ_2, +WQ_{sum1}$
to 2	$+WQ_3, +WQ_4, +WQ_{sum2}$
	$+WQ_{sum}$
3P3W3A(3P4W)	$+WQ_1, +WQ_2, +WQ_3, +WQ_{sum}$

Regenerating power (where: P<0)**Active power energy - WP[Wh]**

Displayed digit	6-digit, Unit: m, k, M, G, T (harmonized with +WS)
Display area	0.00000mWh - 9999.99TWh (harmonized with +WS) * "OL" is displayed when the display area is exceeded.
Equation	$-WPc = \frac{1}{h} \left(\sum_i (-P_{ci}) \right)$ <p>h: integration period (3600 sec), c: Measurement channel, i: Data point no.</p>
1P2W-1 to 4	$-WP_1, -WP_2, -WP_3, -WP_4, -WP_{sum}$
1P3W(3P3W)-1	$-WP_1, -WP_2, -WP_{sum1}$
to 2	$-WP_3, -WP_4, -WP_{sum2}$
	$-WP_{sum}$
3P3W3A(3P4W)	$-WP_1, -WP_2, -WP_3, -WP_{sum}$

Apparent power energy -WS[VAh]

Displayed digit	6-digit, Unit: m, k, M, G, T (harmonized with $+WS$)
Display area	0.00000mVAh - 9999.99TVAh (harmonized with $+WS$) * "OL" is displayed when the display area is exceeded.
Equation	$-WS_c = \frac{1}{h} \left(\sum_i (S_{ci}) \right)$ <p>h: integration period (3600 sec), c: Measurement channel, i: Data point no.</p>
1P2W-1 to 4	$-WS_1, -WS_2, -WS_3, -WS_4, -WS_{sum}$
1P3W(3P3W)-1 to 2	$-WS_1, -WS_2, -WS_{sum1}$ $-WS_3, -WS_4, -WS_{sum2}$ $-WS_{sum}$
3P3W3A(3P4W)	$-WS_1, -WS_2, -WS_3, -WS_{sum}$

Reactive power energy -WQ [Varh]

Displayed digit	6-digit, Unit: m, k, M, G, T (harmonized with $+WS$)
Display area	0.00000mvarh - 9999.99Tvarh (harmonized with $+WS$) * "OL" is displayed when the display area is exceeded.
Equation	<p>Leading phase $-WQ_{c_c} = \frac{1}{h} \left(\sum_i (+Q_{ci}) \right),$</p> <p>Lagging phase $-WQ_{i_c} = \frac{1}{h} \left(\sum_i (-Q_{ci}) \right)$</p> <p>h: integration period (3600 sec), n: System No., c: Measurement channel, i: Data point no. * where: Lagging phase: $Q \geq 0$, Leading phase: $Q < 0$</p>
1P2W-1 to 4	$-WQ_1, -WQ_2, -WQ_3, -WQ_4, -WQ_{sum}$
1P3W(3P3W)-1 to 2	$-WQ_1, -WQ_2, -WQ_{sum1}$ $-WQ_3, -WQ_4, -WQ_{sum2}$ $-WQ_{sum}$
3P3W3A(3P4W)	$-WQ_1, -WQ_2, -WQ_3, -WQ_{sum}$

Duration of integration

Display area	00:00:00 (0 sec) - 99:59:59 (99 h 59 min 59 sec), 0100:00 - 9999:59 (9999 h 59 min), 010000 - 999999 (999999 h) * Displayed time will transit in series.
--------------	--

Items measured at Demand measurement

Target value (DEM_{Target})

Displayed digit	4-digit
Unit	m, k, M, G, T
Display range	0.000mW(VA) - 999.9TW(VA) *according to the selected values

Predicted value (DEM_{Guess})

Displayed digit	6-digit
Unit	m, k, M, G, T (depending on DEM_{Target} value)
Display range	0.00000mW(VA) - 99999.9TW(VA) * Decimal point is dependent on the DEM_{Target} . * "OL" is displayed when the display area is exceeded.
Equation	$DEM_{Guess} = \Sigma DEM \times \frac{Demand\ interval}{Elapsed\ time}$

Present value, Measured demand value (ΣDEM)

Displayed digit	6-digit , Unit: m, k, M, G, T (depending on DEM_{Target} value)
Unit	m, k, M, G, T (depending on DEM_{Target} value)
Display range	0.00000mW(VA) - 99999.9TW(VA) * Decimal point is dependent on the DEM_{Target} . * "OL" is displayed when the display area is exceeded.
Equation	$\Sigma DEM =$ (Integration values of "+WPsum (+WSsum)") $\times \frac{1\ hour}{Interval}$

Load factor

Displayed digit	6-digit
Display range	0.00 - 9999.99% * "OL" is displayed when the display area is exceeded.
Equation	$\frac{\Sigma DEM}{DEM_{Target}}$

Estimation

Displayed digit	6-digit
Display range	0.00 - 9999.99% * "OL" is displayed when the display area is exceeded.
Equation	$\frac{DEM_{Guess}}{DEM_{Target}}$

Items measured at Harmonics measurement

Meas. system	: Digital PLL synchronization
Meas. method	: Analyze harmonics, and then add and display the inter-harmonics components adjacent to the integral order of the analyzed harmonics
Effective frequency range	: 40 - 70Hz
Order analysis	: 1 - 50th
Window width	: 10-cycle at 50Hz, 12-cycle at 60Hz
Window type	: Rectangular
Data analysis	: 2048 points
Analyzing rate	: once/ 200ms at 50Hz/60Hz

R. m.s. harmonics voltage V_k [Vrms]

Range	Same as r.m.s. voltage
Displayed digit	Same as r.m.s. voltage
Display range	Same as r.m.s. voltage * rate of content 0.0% - 100.0%, percentage against the basic wave
Measurement system	Complied with IEC61000-4-30, IEC61000-4-7, IEC61000-2-4 Analysis window width is 10/12-cycle for 50/60Hz, and the measured values contain the inter-harmonics components adjacent to the analyzed order.
Accuracy	Complied with IEC61000-2-4 Class3 where 10% - 100% of input range for 600V Range. 3% or more against 100V of nominal voltage : $\pm 10\%rdg$ Less than 3% against 100V of nominal voltage : nominal voltage $\pm 0.3\%$ 1000V Range : $\pm 0.2\%rdg \pm 0.2\%f.s.$
Equation	$V_{ck} = \sqrt{\sum_{n=-1}^1 (V_c(10k+n)_r)^2 + (V_c(10k+n)_i)^2}$ Rate of content = $\frac{V_{ck} \times 100}{V_{c1}}$ c: Measurement channel, k: Harmonics of each order Vr: Real number after Voltage FFT conversion Vi: Imaginary number after Voltage FFT conversion Measurement cycle in this equation is 10-cycle. For 12-cycle measurement, "10k+n" should be replaced with "12k+n".
1P2W-1 to 4	V_{1k}
1P3W-1 to 2	V_{1k}, V_{2k}
3P3W-1 to 2	Line voltage V_{12k}, V_{32k}
3P3W3A	Line voltage $V_{12k}, V_{23k}, V_{31k}$
3P4W	V_{1k}, V_{2k}, V_{3k}

R.m.s. harmonics current A_k [Arms]

Range	Same as r.m.s. current
Displayed digit	Same as r.m.s. current
Display range	Same as r.m.s. current * Rate of content: 0.0% - 100.0% (percentages to the basic wave)
Meas. system	Complied with IEC61000-4-7, IEC61000-2-4 Analysis window width: 10/12 cycle for 50/60Hz, Measured values contain the inter-harmonics adjacent to the analyzed orders' harmonics
Accuracy	Meets the accuracy specified in IEC61000-2-4 Class3 at 10% - 100% of the input range of the measurement range. 10% or more to max. input range : $\pm 10\% \text{rdg} + \text{Accuracy of Clamp sensor}$ Less than 10% to max. input range : $\text{max value of the range} \pm 1.0\% + \text{Accuracy of Clamp sensor}$
Equation	$A_{ck} = \sqrt{\sum_{n=-1}^1 (A_c(10k+n)r)^2 + (A_c(10k+n)i)^2}$ <p>Rate of content = $\frac{A_{ck} \times 100}{A_{c1}}$</p> <p>c: Measurement channel: $A_{1k}, A_{2k}, A_{3k}, A_{4k}$, k: Harmonics of each order r: Real number after FFT conversion, i: Imaginary number after FFT conversion Measurement cycle in this equation is 10-cycle. For 12-cycle measurement, "10k+n" should be replaced with "12k+n".</p>

Harmonics power P_k [W]

Range	Same as active power
Displayed digit	Same as active power
Display range	Same as active power * rate of content 0.0% - 100.0%, percentage against the absolute value of basic wave
Meas. system	Complied with IEC61000-4-7
Accuracy	$\pm 0.3\% \text{rdg} \pm 0.2\% \text{f.s.} + \text{accuracy of clamp sensor (PF 1, sine wave: 50/60Hz)}$ (Sum represents the total values obtained through the used channels.)
Equation	$P_{ck} = V_{c(10k)r} \times A_{c(10k)r} - V_{c(10k)i} \times A_{c(10k)i}$ <p>Rate of content = $\frac{P_{ck} \times 100}{P_{c1}}$</p> <p>c: Measurement channel, k: Harmonics of each order r: Real number after FFT conversion, i: Imaginary number after FFT conversion Measurement cycle in this equation is 10-cycle. For 12-cycle measurement, "10k" should be replaced with "12k".</p>
1P2W-1 to 4	$P_{1k}, P_{2k}, P_{3k}, P_{4k}, P_{sumk} = P_{1k} + P_{2k} + P_{3k} + P_{4k}$
1P3W-1 to 2	$P_{1k}, P_{2k}, P_{sum1k} = P_{1k} + P_{2k}$ $P_{3k}, P_{4k}, P_{sum2k} = P_{3k} + P_{4k}$ $P_{sumk} = P_{sum1k} + P_{sum2k}$
3P3W-1 to 2	$P_{1k}, P_{2k}, P_{sum1k} = P_{1k} + P_{2k}$ $P_{3k}, P_{4k}, P_{sum2k} = P_{3k} + P_{4k}$ $P_{sumk} = P_{sum1k} + P_{sum2k}$
3P3W3A	Phase voltage $P_{1k} \cdot V_1 = (V_{12} - V_{31})/3, P_{2k} \cdot V_2 = (V_{23} - V_{12})/3,$ $P_{3k} \cdot V_3 = (V_{31} - V_{23})/3, P_{sumk} = P_{1k} + P_{2k} + P_{3k}$
3P4W	$P_{1k}, P_{2k}, P_{3k}, P_{sumk} = P_{1k} + P_{2k} + P_{3k}$

Harmonics reactive power Q_k [var] (used for internal calculation only)

Equation	$P_{c_k} = V_{c(10k)} r \times A_{c(10k)} i - V_{c(10k)} i \times A_{c(10k)} r$ c: Measurement channel: $A_{1k}, A_{2k}, A_{3k}, A_{4k}$, k: Harmonics of each order r: Real number after FFT conversion, i: Imaginary number after FFT conversion Measurement cycle in this equation is 10-cycle. For 12-cycle measurement, "10k" should be replaced with "12k".
1P2W-1 to 4	$Q_{1k}, Q_{2k}, Q_{3k}, Q_{4k}, Q_{sumk} = Q_{1k} + Q_{2k} + Q_{3k} + Q_{4k}$
1P3W-1 to 2	$Q_{1k}, Q_{2k}, Q_{sum1k} = Q_{1k} + Q_{2k}$
	$Q_{3k}, Q_{4k}, Q_{sum2k} = Q_{3k} + Q_{4k}$
	$Q_{sumk} = Q_{sum1k} + Q_{sum2k}$
3P3W-1 to 2	$Q_{1k}, Q_{2k}, Q_{sum1k} = Q_{1k} + Q_{2k}$
	$Q_{3k}, Q_{4k}, Q_{sum2k} = Q_{3k} + Q_{4k}$
	$Q_{sumk} = Q_{sum1k} + Q_{sum2k}$
3P3W3A	Phase voltage $Q_{1k}: V_1 = (V_{12} - V_{31})/3$, $Q_{2k}: V_2 = (V_{23} - V_{12})/3$, $Q_{3k}: V_3 = (V_{31} - V_{23})/3$, $Q_{sumk} = Q_{1k} + Q_{2k} + Q_{3k}$
3P4W	$Q_{1k}, Q_{2k}, Q_{3k}, Q_{sumk} = Q_{1k} + Q_{2k} + Q_{3k}$

Harmonics voltage total distortion factor THDVF [%]

Displayed digit	4-digit
Display range	0.0% - 100.0%
Equation	$THDVF_c = \frac{\sqrt{\sum_{k=2}^{50} (V_{ck})^2}}{V_{c1}} \times 100$ c: Meas. channel V: Harmonics voltage k: Harmonics of each order
1P2W-1 to 4	$THDVF_1$
1P3W-1 to 2	$THDVF_1, THDVF_2$
3P3W-1 to 2	Line voltage $THDVF_{12}, THDVF_{32}$
3P3W3A	Line voltage $THDVF_{12}, THDVF_{23}, THDVF_{31}$
3P4W	$THDVF_1, THDVF_2, THDVF_3$

Harmonics current total distortion factor THDAF [%]

Displayed digit	4-digit
Display range	0.0% - 100.0%
Equation	$THDAF_c = \frac{\sqrt{\sum_{k=2}^{50} (A_{ck})^2}}{A_{c1}} \times 100$ c: Meas. ch $THDAF_1, THDAF_2,$ $THDAF_3, THDAF_4$ A: Harmonics current k: Harmonics of each order

Harmonics voltage total distortion factor THDVR [%]

Displayed digit	4-digit	
Display range	0.0% - 100.0%	
Equation	$THDVR_c = \frac{\sqrt{\sum_{k=2}^{50} (V_{ck})^2} \times 100}{\sqrt{\sum_{k=1}^{50} (V_{ck})^2}}$	c: Meas. channel V: Harmonics voltage k: Harmonics of each order
1P2W-1 to 4	$THDVR_1$	
1P3W-1 to 2	$THDVR_1, THDVR_2$	
3P3W-1 to 2	Line voltage $THDVR_{12}, THDVR_{32}$	
3P3W3A	Line voltage $THDVR_{12}, THDVR_{23}, THDVR_{31}$	
3P4W	$THDVR_1, THDVR_2, THDVR_3$	

Harmonics current total distortion factor THDAR [%]

Displayed digit	4-digit	
Display range	0.0% - 100.0%	
Equation	$THDAR_c = \frac{\sqrt{\sum_{k=2}^{50} (A_{ck})^2} \times 100}{\sqrt{\sum_{k=1}^{50} (A_{ck})^2}}$	c: Meas. ch. $THDAR_1, THDAR_2,$ $THDAR_3, THDAR_4$ A: Harmonics current k: Harmonics of each order

Harmonics voltage phase angle θV_k [deg]

Displayed digit	4-digit	
Display range	0.0° to ±180.0°	
Equation	$\theta V_{ck} = \tan^{-1} \left\{ \frac{V_{ckr}}{-V_{cki}} \right\}$	c: Measurement channel V: Harmonics voltage k: Harmonics of each order r: Real number after FFT conversion, i: Imaginary number after FFT conversion
1P2W-1 to 4	θV_{1k}	
1P3W-1 to 2	$\theta V_{1k}, \theta V_{2k}$	
3P3W-1 to 2	$\theta V_{12k}, \theta V_{32k}$ * Line voltages are used.	
3P3W3A	$\theta V_{12k}, \theta V_{23k}, \theta V_{31k}$ * Line voltages are used.	
3P4W	$\theta V_{1k}, \theta V_{2k}, \theta V_{3k}$	

Total harmonics current phase angle θ_{Ak} [deg]

Displayed digit	4-digit
Display range	0.0° to ±180.0°
Equation	$\theta_{A_{ck}} = \tan^{-1} \left\{ \frac{A_{ckr}}{-A_{cki}} \right\}$ <p>c: Measurement channel $\theta_{A_{1k}}, \theta_{A_{2k}}, \theta_{A_{3k}}, \theta_{A_{4k}}$ A: Harmonics current k: Harmonics of each order r: Real number after FFT conversion, i: Imaginary number after FFT conversion</p>

Harmonics voltage current phase angle difference θ_k [deg]

Displayed digit	4-digit
Display range	0.0° to ±180.0°
Equation	$\theta_{ck} = \theta_{A_{ck}} - \theta_{V_{ck}}$ c: Measurement channel, k: Harmonics of each order
1P2W-1 to 4	$\theta_{1k}, \theta_{2k}, \theta_{3k}, \theta_{4k}, \theta_{sumk} = \tan^{-1} \left\{ \frac{Q_{sumk}}{P_{sumk}} \right\}$
1P3W(3P3W)-1 to 2	$\theta_{1k}, \theta_{2k}, \theta_{sum1k} = \tan^{-1} \left\{ \frac{Q_{sum1k}}{P_{sum1k}} \right\}$ <hr/> $\theta_{3k}, \theta_{4k}, \theta_{sum2k} = \tan^{-1} \left\{ \frac{Q_{sum2k}}{P_{sum2k}} \right\}$ <hr/> $\theta_{sumk} = \tan^{-1} \left\{ \frac{Q_{sumk}}{P_{sumk}} \right\}$
3P3W3A(3P4W)-1	$\theta_{1k}, \theta_{2k}, \theta_{3k}, \theta_{sumk} = \tan^{-1} \left\{ \frac{Q_{sumk}}{P_{sumk}} \right\}$

Items measured at Power quality measurement

Voltage transient

Meas. system	Approx. 40.96ksps (every 2.4 μ s) gapless event detection (50Hz/60Hz)
Displayed digit	4-digit
Effective input range	50V - 2200V (DC)
Display range	50V - 2200V (DC)
Accuracy	0.5%rdg * at 1000V (DC)
Input impedance	Approx. 1.67M Ω
Threshold value	Absolute peak voltage value
Detection channel (ch)	
1P2W-1 to 4	V_1
1P3W-1 to 2	V_1, V_2
3P3W-1 to 2	Line voltage V_{12}, V_{32}
3P3W3A	Line voltage V_{12}, V_{23}, V_{31}
3P4W	V_1, V_2, V_3



Voltage swell, Dip, INT



Range	Same as r.m.s. voltage
Displayed digit	Same as r.m.s. voltage
Effective input range	Same as r.m.s. voltage
Display range	Same as r.m.s. voltage
Crest factor	Same as r.m.s. voltage
Input impedance	Same as r.m.s. voltage
Threshold value	Percentage of the nominal voltage value
Meas. system	Complied with IEC61000-4-3 *r.m.s. values are calculated from one waveform with half-wave overlapping. Swell, dip detection for multi-phase system: Starts when any one of events starts at any ch, Ends when it terminates. INT detection for multi-phase system: Starts when the event starts at all chs, Ends when it terminates at any one of the chs.
Accuracy	10% - 150% (to 100V or higher nominal voltages) : nominal voltage $\pm 1.0\%$ Out of above range : $\pm 0.4\%rdg \pm 0.4\%f.s.$ Errors of event duration measurement at 40 - 70Hz : within 1-cycle
Detection channel (ch)	
1P2W-1 to 4	V_1
1P3W-1 to 2	V_1, V_2
3P3W-1 to 2	Line voltage V_{12}, V_{32}
3P3W3A	Line voltage V_{12}, V_{23}, V_{31}
3P4W	V_1, V_2, V_3



Inrush current



Range	Same as r.m.s. current
Displayed digit	Same as r.m.s. current
Effective input range	Same as r.m.s. current
Display range	Same as r.m.s. current
Crest factor	Same as r.m.s. current
Input impedance	Same as r.m.s. current
Threshold value	Percentage of the measurement range
Meas. system	Calculate r.m.s. values from one waveform with half-wave overlapping.
Accuracy	$\pm 0.4\% \text{rdg} \pm 0.4\% \text{f.s.} + \text{accuracy of clamp sensor}$
Detection channel (ch)	A_1, A_2, A_3, A_4

10.4 Specification of Clamp sensor

	<MODEL8128 >	<MODEL8127 >	<MODEL8126 >
			
Rated current	AC 5Arms [Max. AC50Arms(70.7Apeak)]	AC 100Arms (141Apeak)	AC 200Arms (283Apeak)
Output voltage	0 - 50mV (AC 50mV/AC 5A) [Max.AC 500mV/AC50A]:10mV/A	AC0 - 500mV (AC500mV/AC100A):5mV/A	AC0 - 500mV (AC 500mV/AC200A):2.5mV/A
Measuring range	AC0 - 50Arms	AC0 - 100Arms	AC0 - 200Arms
Accuracy (sine wave input)	±0.5%rdg±0.1mV (50/60Hz) ±1.0%rdg±0.2mV (40Hz - 1kHz)		
Phase characteristics	within ±2.0° (0.5 - 50A/45 - 65Hz)	within ±2.0° (1 - 100A/45 - 65Hz)	within ±1.0° (2 - 200A/45 - 65Hz)
Temp. & humidity range (guaranteed accuracy)	23±5°C, relative humidity 85% or less (no condensation)		
Operating temp. range	0 - 50°C, relative humidity 85% or less (no condensation)		
Storage temp. range	-20 to 60°C, relative humidity 85% or less (no condensation)		
Allowable input	AC50Arms (50/60Hz)	AC100Arms (50/60Hz)	AC200Arms(50/60Hz)
Output impedance	Approx. 20Ω	Approx. 10Ω	Approx. 5Ω
Location for use	In-door use, altitude 2000m or less		
Applicable standards	IEC 61010-1, IEC 61010-2-032 Meas. CAT. III (300V), Pollution degree 2 IEC61326		IEC 61010-1, IEC 61010-2-032 Meas. CAT. III (600V), Pollution degree 2, IEC61326
Withstand voltage	AC3540V/5 sec. Between Jaws - Enclosure, Enclosure - Output terminal, and Jaws - Output terminal		AC3350V/5 sec. Between Jaws - Enclosure, Enclosure - Output terminal, and Jaws - Output terminal
Insulation resistance	50MΩ or more/ 1000V Between Jaws - Enclosure, Enclosure - Output terminal, and Jaws - Output terminal		
Max conductor size	Approx. ø24mm (max.)		Approx. ø40mm (max.)
Dimension	100(L)×60(W)×26(D)mm		128(L)×81(W)×36(D)mm
Cable length	Approx. 3m		
Output terminal	MINI DIN 6PIN		
Weight	Approx. 160g		Approx. 260g
Accessory	Instruction manual Cable marker		
Optional parts	7146 (Banana ø 4 Adjuster plug), 7185(Extension cable)		

	<MODEL8125 >	<MODEL8124 >
		
Rated current	AC 500Arms (707Apeak)	AC 1000Arms (1414Apeak)
Output voltage	AC0 - 500mV (AC500mV/500A):AC 1mV/A	AC0 - 500mV (AC500mV/1000A):0.5mV/A
Measuring range	AC0 - 500Arms	AC0 - 1000Arms
Accuracy (sine wave input)	$\pm 0.5\%rdg \pm 0.1mV$ (50/60Hz) $\pm 1.0\%rdg \pm 0.2mV$ (40Hz - 1kHz)	$\pm 0.5\%rdg \pm 0.2mV$ (50/60Hz) $\pm 1.5\%rdg \pm 0.4mV$ (40Hz - 1kHz)
Phase characteristics	within $\pm 1.0^\circ$ (5 - 500A/45 - 65Hz)	within $\pm 1.0^\circ$ (10 - 1000A/45 - 65Hz)
Temp. & humidity range (guaranteed accuracy)	23 \pm 5°C, relative humidity 85% or less (no condensation)	
Operating temp. range	0 - 50°C, relative humidity 85% or less (no condensation)	
Storage temp. range	-20~60°C, relative humidity 85% or less (no condensation)	
Allowable input	AC500Arms (50/60Hz)	AC1000Arms (50/60Hz)
Output impedance	Approx. 2 Ω	Approx. 1 Ω
Location for use	In-door use, altitude 2000m or less	
Applicable standards	IEC 61010-1, IEC 61010-2-032 Meas. CAT. III (600V), Pollution degree 2 IEC61326	
Withstand voltage	AC5350V/5 sec Between Jaws - Enclosure, Enclosure - Output terminal, and Jaws - Output terminal	
Insulation resistance	50M Ω or more/ 1000V Between Jaws - Enclosure, Enclosure - Output terminal, and Jaws - Output terminal	
Max conductor size	Approx. $\phi 40mm$ (max.)	Approx. $\phi 68mm$ (max.)
Dimension	128(L) \times 81(W) \times 36(D)mm	186(L) \times 129(W) \times 53(D)mm
Cable length	Approx. 3m	
Output terminal	MINI DIN 6PIN	
Weight	Approx. 260g	Approx. 510g
Accessory	Instruction manual, Cable marker	
Optional parts	7146 (Banana ϕ 4 Adjuster plug), 7185(Extension cable)	

<KEW8129 >	<KEW8130 >
	
300A Range: AC 300 Arms(424Apeak) 1000A Range: AC 1000 Arms(1414Apeak) 3000A Range: AC 3000 Arms(4243Apeak)	AC 1000 Arms(1850Apeak)
300A Range: AC0 - 500mV(AC500mV/AC 300A):1.67mV/A 1000A Range: AC0 - 500mV(AC500mV/AC1000A):0.5mV/A 3000A Range: AC0 - 500mV(AC500mV/AC3000A):0.167mV/A	AC0 - 500mV (AC500mV/AC1000A):0.5mV/A
300A Range: 30 - 300Arms 1000A Range: 100 - 1000Arms 3000A Range: 300 - 3000Arms	AC0 - 1000Arms
$\pm 1.0\%rdg$ (45 - 65Hz) (at the center point)	$\pm 0.5\%rdg \pm 0.2mV$ (45 - 65Hz) $\pm 1.5\%rdg \pm 0.4mV$ (40Hz - 1kHz)
within $\pm 1.0^\circ$ (in each measuring range: 45 - 65Hz)	within $\pm 2.0^\circ$ (45 - 65Hz) within $\pm 3.0^\circ$ (40 - 1kHz)
23 \pm 5°C, relative humidity 85% or less (no condensation)	
-10 - 50°C, relative humidity 85% or less (no condensation)	
-20 to 60°C, relative humidity 85% or less (no condensation)	
AC3600Arms (50/60Hz)	AC1300Arms (50/60Hz)
Approx. 100 Ω or less	
In-door use, altitude 2000m or less	
IEC 61010-1, IEC 61010-2-032 Meas. CAT. III (600V) Pollution degree 2 IEC61326	IEC 61010-1, IEC 61010-2-032 Meas. CAT. III (600V)/CAT. IV (300V) Pollution degree 2 IEC61326
AC5350V/5 sec Between circuit - sensor	AC5160V/5 sec Between circuit - sensor
50M Ω or more/ 1000V Between circuit - sensor	
Approx. $\phi 150mm$ (max)	Approx. $\phi 110mm$ (max.)
111(L) \times 61(W) \times 43(D)mm (protrusions are not included)	65(L) \times 25(W) \times 22(D)mm
Sensor part: Approx. 2m	Sensor part: Approx. 2.7m
Output cable: Approx. 1m	Output cable: Approx. 0.2m
MINI DIN 6PIN	
8129-1: Approx. 410g/8129-2: Approx. 680g/8129-3: Approx. 950g	Approx. 170g
Instruction manual, Output cable(M-7199), Carrying case	Instruction manual, Cable marker, Carrying case
-	

	<MODEL8141 >	<MODEL8142 >	<MODEL8143 >
			
Rated current	AC1000mArms		
Output voltage	AC0 - 100mV(AC100mV/AC1000mA)		
Measuring range	AC0 - 1000mArms		
Accuracy (sine wave input)	±1.0%rdg±0.1mV (50/60Hz) ±2.0%rdg±0.1mV (40Hz - 1kHz)		
Phase characteristics	-----		
Temp. & humidity range (guaranteed accuracy)	23±5°C, relative humidity 85% or less (no condensation)		
Operating temp. range	0 - 50°C, relative humidity 85% or less (no condensation)		
Storage temp. range	-20 to 60°C, relative humidity 85% or less (no condensation)		
Allowable input	AC100Arms (50/60Hz)	AC200Arms (50/60Hz)	AC500Arms (50/60Hz)
Output impedance	Approx. 180Ω	Approx. 200Ω	Approx. 120Ω
Location for use	In-door use, altitude 2000m or less		
Applicable standards	IEC 61010-1, IEC 61010-2-032 Meas. CAT. III (300V), Pollution degree 2 IEC61326 (EMC standard)		
Withstand voltage	AC3540V/5 sec Between Jaws - Enclosure, Jaws - Output terminal, and Enclosure - Output terminal		
Insulation resistance	50MΩ or more/ 1000V Between Jaws - Enclosure, Jaws - Output terminal, and Enclosure - Output terminal		
Max conductor size	Approx. ø24mm (max)	Approx. ø40mm (max)	Approx. ø68mm (max)
Dimension	100(L)×60(W)×26(D)mm (protrusions are not included)	128(L)×81(W)×36(D)mm (protrusions are not included)	186(L)×129(W)×53(D)mm (protrusions are not included)
Cable length	Approx. 2m		
Output terminal	MINI DIN 6PIN		
Weight	Approx. 150g	Approx. 240g	Approx. 490g
Accessory	Instruction manual Carrying case		
Optional parts	7146 (Banana ø 4 Adjuster plug) 7185(Extension cable)		

<KEW8146 >	<KEW8147 >	<KEW8148 >
		
AC 30Arms (42.4Apeak)	AC 70Arms (99.0Apeak)	AC 100Arms (141.4Apeak)
AC0 - 1500mV(AC50mV/A)	AC0 - 3500mV(AC50mV/A)	AC0 - 5000mV(AC50mV/A)
AC0 - 30Arms	AC0 - 70Arms	AC0 - 100Arms
0 - 15A ±1.0%rdg±0.1mV (50/60Hz) ±2.0%rdg±0.2mV (40Hz - 1kHz) 15 - 30A ±5.0%rdg (50/60Hz) ±10.0%rdg (45 - 1kHz)	0 - 40A ±1.0%rdg±0.1mV (50/60Hz) ±2.0%rdg±0.2mV (40Hz - 1kHz) 40 - 70A ±5.0%rdg (50/60Hz) ±10.0%rdg (45 - 1kHz)	0 - 80A ±1.0%rdg±0.1mV (50/60Hz) ±2.0%rdg±0.2mV (40Hz - 1kHz) 80 - 100A ±5.0%rdg (50/60Hz) ±10.0%rdg (45 - 1kHz)

23±5°C, relative humidity 85% or less (no condensation)		
0 - 50°C, relative humidity 85% or less (no condensation)		
-20 to 60°C, relative humidity 85% or less (no condensation)		
AC30Arms (50/60Hz)	AC70Arms (50/60Hz)	AC100Arms (50/60Hz)
Approx. 90Ω	Approx. 100Ω	Approx. 60Ω
In-door use, altitude 2000m or less		
IEC 61010-1, IEC 61010-2-032		
Meas. CAT. III (300V) Pollution degree 2		
IEC61326		
AC3540V/5 sec		
Between Jaws - Enclosure,		
Enclosure - Output terminal, and		
Jaws - Output terminal		
50MΩ or more/ 1000V		
Between Jaws - Enclosure, Enclosure - Output terminal, and Jaws - Output terminal		
Approx. ø24mm (max)	Approx. ø40mm (max)	Approx. ø68mm (max)
100(L)×60(W)×26(D)mm	128(L)×81(W)×36(D)mm	186(L)×129(W)×53(D)mm
Approx. 2m		
MINI DIN 6PIN		
Approx. 150g	Approx. 240g	Approx. 510g
Instruction manual		
Cable marker		
7146 (Banana ø 4 Adjuster plug)		
7185(Extension cable)		

11. Troubleshooting

11.1 General troubleshooting

When defect or breakdown of the instrument is suspected, check the following points first. If your problem is not listed in this section, contact your local Kyoritsu distributor.

Symptom	Check
Instrument cannot be powered on. (Nothing is displayed on the LCD.)	<p><u>When operating with an AC power supply:</u></p> <ul style="list-style-type: none"> • Power cord is connected firmly and properly? • No break in the Power cord? • Supply voltage is within the allowable range? <p><u>When operating with batteries:</u></p> <ul style="list-style-type: none"> • Batteries are installed with observing correct polarity? • Size AA Ni-HM batteries are full-charged? • Size AA Alkaline batteries are not exhausted? <p><u>If the problem not solved yet:</u></p> <ul style="list-style-type: none"> • Disconnect the power cord from an AC power source, and then remove all the batteries from the instrument. Insert the batteries again, and connect the power cord to an AC power source. Power on the instrument. If the instrument still does not turn on, instrument failure may be suspected.
Any key doesn't work.	<ul style="list-style-type: none"> • Key lock function is inactivated? • Check the effective Keys on each Range.
Readings are not stable or Inaccurate.	<ul style="list-style-type: none"> • Frequency at voltage ch1 is within the guaranteed accuracy range? It should be between 40 and 70Hz. • Voltage test leads and clamp sensors are connected properly? • Setting of the instrument and the selected wiring configuration are appropriate? • Proper sensors are used with proper settings? • There is no break in the voltage test leads? • Input signal is not interfered? • Strong electric magnetic field does not exist in close proximity? • Measurement environment meets the specification of this instrument?
Incapable of saving data to the internal memory.	<ul style="list-style-type: none"> • Check the number of files in the memory. • If an SD card is inserted in the instrument, remove the card.

Symptom	Check
Data cannot be saved on the SD card.	<ul style="list-style-type: none"> • SD card is inserted correctly? • SD card has been formatted? • Is there available free space in a SD card? • Check the max number of files or capacity of SD card. • Operation of the SD card has been verified? • Verify the proper operation of SD card on other well-known hardware.
Download and setting cannot be done via USB communication.	<ul style="list-style-type: none"> • connection of the USB cable between the instrument and PC. • Run the communication application software “KEW Windows for KEW6315” and check the connected devices are displayed or not. If the devices are not displayed, the USB driver might not be installed correctly. Please refer to the installation manual for “KEW Windows for KEW6315” and re-install the USB driver.
At the self-diagnosis, “NG” judgment is given frequently.	If “NG” is given for “SD Card”, see the check points for “Data cannot be saved in the SD card.” in above column. If “NG” is give for the other items, disconnect the power cord from an AC power source, and then remove all the batteries from the instrument. Insert the batteries again, and connect the power cord to an AC power source, and carry out the self-diagnosis again. If “NG” is still given, instrument failure may be suspected.

11.2 Error messages and actions

Error message may appear on the LCD while using the instrument. Please check the following table if any error message appears, and take action.

Message	Detail & Action
No SD card. Check the amount of free space in the SD card.	<ul style="list-style-type: none"> • Check the SD card is inserted correctly. See “4.3 Placing/removing SD card” (P. 33).
Check the amount of free space in the SD card.	<ul style="list-style-type: none"> • Check the free space on the SD card. If the space is not enough, delete unnecessary files, format the card or use another card. The SD card should be formatted on KEW6315, not on the PC. See “To delete, transfer or format the recorded data” (P. 82).
Failed to detect sensors. Check the connection of the sensor(s).	<ul style="list-style-type: none"> • Check the connection of current sensor. • If any problem is suspected, please do the following checks. Connect the current sensor, for which “NG” is given, to the CH on which another sensor is properly detected. If the result “NG” is given for the same CH, a defect of the instrument is suspected. A defect of sensor is suspected if “NG” is given for the same sensor connected to another CH. If NG result is given, stop using

the instrument or the sensor.

Message	Detail & Action
Battery level is low. Powering off...	<ul style="list-style-type: none"> Connect the instrument to an AC power source, or replace the batteries with new ones. * Size AA Alkaline battery (LR6) or fully-charged Size AA Ni-MH battery x 6pcs See "How to install batteries" (P. 31).
Not having free space on the internal memory. Format the memory or delete unnecessary files.	<ul style="list-style-type: none"> Check the free space on the internal memory and the number of the saved files. Max number of the file that can be saved on the memory is: 3 for measurement data and 8 for the other data. If the free space is not enough, delete unnecessary files, format the memory. See "To delete, transfer or format the recorded data" (P. 82).
Cannot read the setting file. The file may be damaged.	<ul style="list-style-type: none"> Try again. If still the setting files are not read; <ul style="list-style-type: none"> * problems with SD card or KEW6315 are suspected, if the setting files are on the SD card, * problems with KEW6315 are suspected, if the setting files are in the internal memory. If the problem with KEW6315 is suspected, stop using the instrument.
Available memory is low. Check the amount of free space in the SD card and internal memory. There is no available space in the storage area.	<ul style="list-style-type: none"> Check the free space and the number of saved files on the SD card and the internal memory. Max number of the file that can be saved on the memory is: 3 for measurement data and 8 for the other data. If the space is not enough, delete unnecessary files, format the card or memory. When using another SD card, it should be formatted on KEW6315, not on the PC. See "To delete, transfer or format the recorded data" (P. 82).
Start time is set in the past. Check the recording start method.	<ul style="list-style-type: none"> REC Start is either "Constant rec. / Time period rec." and the time set for REC End is set to the past. Check and modify the time and date. See "(8)/(9) Setting for recording method" (P. 45).
Failed to start recording.	<ul style="list-style-type: none"> Check the "Recording setting" at SET UP menu. See "5.4 Recording setting" (P. 71). Try again. If still a record does not start, there may be a problem with either the SD card or the internal memory. Check which is set as the destination to save the data. If the destination is internal memory, a problem with KEW6315 is suspected. Stop using the instrument in this case.
Cannot change the instrument settings during recording or in stand-by mode.	<ul style="list-style-type: none"> Change of setting is not allowed during a record. To change the settings, stop record and confirm "Recording stopped." message appears and then disappears.

Message	Detail & Action
<p>New sensor is detected. Recheck the basic setting for SET UP before measurements.</p>	<ul style="list-style-type: none"> • The connected Clamp sensors are not the same ones used during the previous test. Modify the settings of clamp sensor directly from the “Basic setting” or press the “Detect” key.
<p>Sensor connection is not correct. Check the connected sensor(s).</p>	<ul style="list-style-type: none"> • Appropriate current sensor may not be connected to the measurement channels. Check the wiring configuration and the connected sensor.
<p>Out of SD card space. Recording will be stopped.</p>	<ul style="list-style-type: none"> • First, stop the recording. Confirm “Recording stopped.” message appears, and then disappears. Backup the data file to PC or any other medias, and then delete files or format. When using another SD card, it should be formatted on KEW6315, not on the PC. See “To delete, transfer or format the recorded data” (P. 82).
<p>Out of internal memory space. Recording will be stopped.</p>	<ul style="list-style-type: none"> • First, stop the recording. Confirm “Recording stopped.” message appears, and then disappears. Backup the data file to PC or SD cards, and then delete files or format. See “To delete, transfer or format the recorded data” (P. 82).

DISTORIBUTOR

Kyoritsu reserves the rights to change specifications or designs described in this manual without notice and without obligations.



**KYORITSU ELECTRICAL
INSTRUMENTS
WORKS, LTD.**

2-5-20, Nakane, Meguro-ku,

Tokyo, 152-0031 Japan

Phone: +81-3-3723-0131

Fax: +81-3-3723-0152

URL: <http://www.kew-ltd.co.jp>

E-mail: info-eng@kew-ltd.co.jp

Factory: Ehime, Japan

www.kew-ltd.co.jp