

USER MANUAL

Si-CPE320

MULTIFUNCTION PANEL TRANSMITTER

Table of contents

| | |
|---|-----------|
| 1. Safety instructions | 5 |
| 1.1 Warnings..... | 5 |
| 1.2 Environment protection | 5 |
| 1.3 Symbols used | 5 |
| 2. Conformity and standard | 6 |
| 2.1 FCC rules | 6 |
| 2.2 Canadian standard | 6 |
| 3. Introduction | 7 |
| 3.1 Description of the transmitter | 7 |
| 3.1.1 Overall description..... | 7 |
| 3.1.2 Screen description | 7 |
| 3.2 Connections..... | 8 |
| 4. Mounting | 9 |
| 5. Electrical connections | 10 |
| 6. First Start-up | 11 |
| 6.1 Set the transmitter | 11 |
| 6.2 Connect a probe..... | 11 |
| 6.3 Set a channel | 12 |
| 6.4 Set an output | 13 |
| 6.5 Disconnect a probe..... | 13 |
| 7. Transmitter features | 14 |
| 7.1 General features..... | 14 |
| 7.2 Features of the housing | 14 |
| 7.3 Dimensions | 15 |
| 7.4 Possible optional measurements | 15 |
| 8. Set the transmitter | 16 |
| 8.1 Set the language | 16 |
| 8.2 Set the country..... | 16 |
| 8.3 Set the date, time zone and time | 16 |
| 8.4 Set the brightness | 16 |
| 9. Set inputs and outputs | 17 |
| 9.1 Set the measurement channels | 17 |
| 9.2 Set the outputs..... | 17 |
| 9.2.1 Set the analog outputs | 17 |
| 9.2.2 Perform an output diagnostic..... | 18 |
| 9.2.3 Set the digital output (Modbus RTU) | 19 |
| 9.3 Set the probes and the pressure module | 19 |
| 9.3.1 Normative values..... | 19 |
| 9.3.2 Configure the compensation of a CO ₂ or hygrometry probe | 19 |
| 9.3.3 Configure the differential pressure module..... | 20 |
| 9.4 Set the alarms | 22 |
| 9.4.1 Set the alarm thresholds | 22 |
| 9.4.2 Set the alarms parameters | 22 |
| 9.5 Set the autozero..... | 23 |
| 10. Security and connectivity | 24 |
| 10.1 Wireless communication | 24 |
| 10.2 Define the security code | 24 |
| 10.3 Define the Touch Lock functionality..... | 24 |
| 10.4 Reset instrument from factory..... | 24 |
| 11. Information about transmitter, probes and module | 26 |
| 11.1 Instrument, probes and module information..... | 26 |

| | |
|---|-----------|
| 11.2 Adjustment and calibration information | 26 |
| 11.3 Probe update | 26 |
| 12. Maintenance and precautions for use | 27 |
| 12.1 Maintenance | 27 |
| 12.2 Precautions for use | 27 |
| 13. Modbus | 28 |
| 13.1 Configuration of parameters | 28 |
| 13.2 Functions | 28 |
| 13.3 Data format | 28 |
| 13.4 Enumeration table | 28 |
| 13.4.1 Languages enumeration | 28 |
| 13.4.2 Units enumeration | 29 |
| 13.4.3 Measurements enumeration | 29 |
| 13.4.4 Other enumeration | 29 |
| 13.5 Description of function and Modbus connections | 30 |
| 13.5.1 Device | 30 |
| 13.5.2 Channels | 31 |
| 13.5.3 Outputs | 31 |
| 13.5.4 Alarms parameters | 32 |
| 13.5.5 Probes and module parameters | 34 |
| 13.5.6 Normative values | 37 |
| 13.5.7 Measurement alarms | 37 |

1. Safety instructions

Before using the device, please read carefully this user manual. It delivers important information about the device operations, maintenance and storage.

1.1 Warnings

- Interior use.
- Respect the measuring ranges of the probes and modules connected to the transmitter.
- This device has been developed to measure simultaneous parameters including differential pressure, temperature (Pt100 and thermocouple), hygrometry, air quality (CO/CO₂/VOC), air velocity, airflow, air change rate. It must not be used in any other purpose.
- This device has been developed and produced to be sold exclusively to trained and qualified HVACR technicians and engineers. Appropriate training might be necessary in order to ensure safe use of this instrument. Sauermann is not responsible for any possible accident during its use.
- Please always use the device in accordance with its intended use and within parameters described in the technical features in order not to compromise the protection ensured by the device.
- When using the device, the safety of the system integrating the device is the responsibility of the system assembler.
- This device can pose a risk for pacemaker wearers. Respect a distance of at least 10 cm (4") between the device and the wearer.
- Respect a safety distance with other electronic devices like computers, credit cards, computer or TV screens which could be damaged by the magnetic field of the apparel.
- Only the accessories provided with the device or available as an option must be used.
- Do not use the device if it is damaged or if it operates abnormally. Inspect the device before every use. In case of doubt, please contact Sauermann's After-sales service.
- Do not authorize pressures beyond the device limits. Please refer to the technical features described in this user manual.
- The device must not be exposed to rain or any other humid environments (> 85 %RH) without using a proper protection.
- Do not use the device next to explosive and corrosives gases, vapours or dust.
- Do not place your fingers in movable zones of the device (articulations).
- The device must not be used in ATEX zones according to applicable standards.
- Do not store the device with solvents. Do not use desiccants. Do not use isopropanol.
- During use, keep inspecting the device and accessories for effective operation and your own safety.
- Do not give this product to a child.
- If the device falls or in case of similar inconveniences, or if an irregular malfunction appears, please send back the device to Sauermann's After-sales service for a technical check and to ensure your own safety.

1.2 Environment protection

Send back the device at its end of working life for waste collection center of electrical and electronic components (according to local regulations), or send it back to Sauermann to ensure a required waste collection in the respect of the environment.

1.3 Symbols used

For your safety and in order to avoid any damage of the device, please follow the procedure described in this user manual and read carefully the notes preceded by the following symbol:



The following symbol will also be used in this user manual:

Please read carefully the information notes indicated after this symbol.

© 2023 SAUERMANN. All rights reserved. Sauermann and Sauermann Control App are the exclusive property of Sauermann. Non contractual document. The products functionalities and visual appearances can be modified without prior notice. Smartphone or tablet are not supplied with Sauermann products.

2. Conformity and standard

The transmitter complies with 2015/863 EU (RoHS 3). Document available on request.

Hereby, Sauermann Industrie SAS declares that the radio equipment type Si-CPE320 is in compliance with Directive 2014/53/EU. The full text of the EU declaration of conformity is available at the following internet address: sauermanngroup.com.

2.1 FCC rules

This equipment has been tested and found to comply with the limits for a Class B digital device, pursuant to part 15 of the FCC Rules. These limits are designed to provide reasonable protection against harmful interference in a residential installation. This equipment generates, uses and can radiate radio frequency energy and, if not installed and used in accordance with the instructions, may cause harmful interference to radio communications. However, there is no guarantee that interference will not occur in a particular installation. If this equipment does cause harmful interference to radio or television reception, which can be determined by turning the equipment off and on, the user is encouraged to try to correct the interference's by one or more of the following measures:

- Reorient or relocate the receiving antenna.
- Increase the separation between the equipment and receiver.
- Connect the equipment into an outlet on a circuit different from that to which the receiver is connected
- Consult the dealer or an experienced radio/TV technician for help.

Changes or modifications not expressly approved by Sauermann could voice the user's authority to operate the equipment.

This device complies with part 15 of the FCC Rules.

Operation is subject to the following two conditions:

1. This device may not cause interference, and
2. This device must accept any interference received, including interference that may cause undesired operation.

2.2 Canadian standard

This device contains licence-exempt transmitter(s)/receiver(s) that comply with innovation, Science and Economic Development Canada's licence-exempt RSS(s). Operation is subject to the following two conditions:

1. This device may not cause interference
2. This device must accept any interference, including interference that may cause undesired operation of the device.

3.1 Description of the transmitter

3.1.1 Overall description

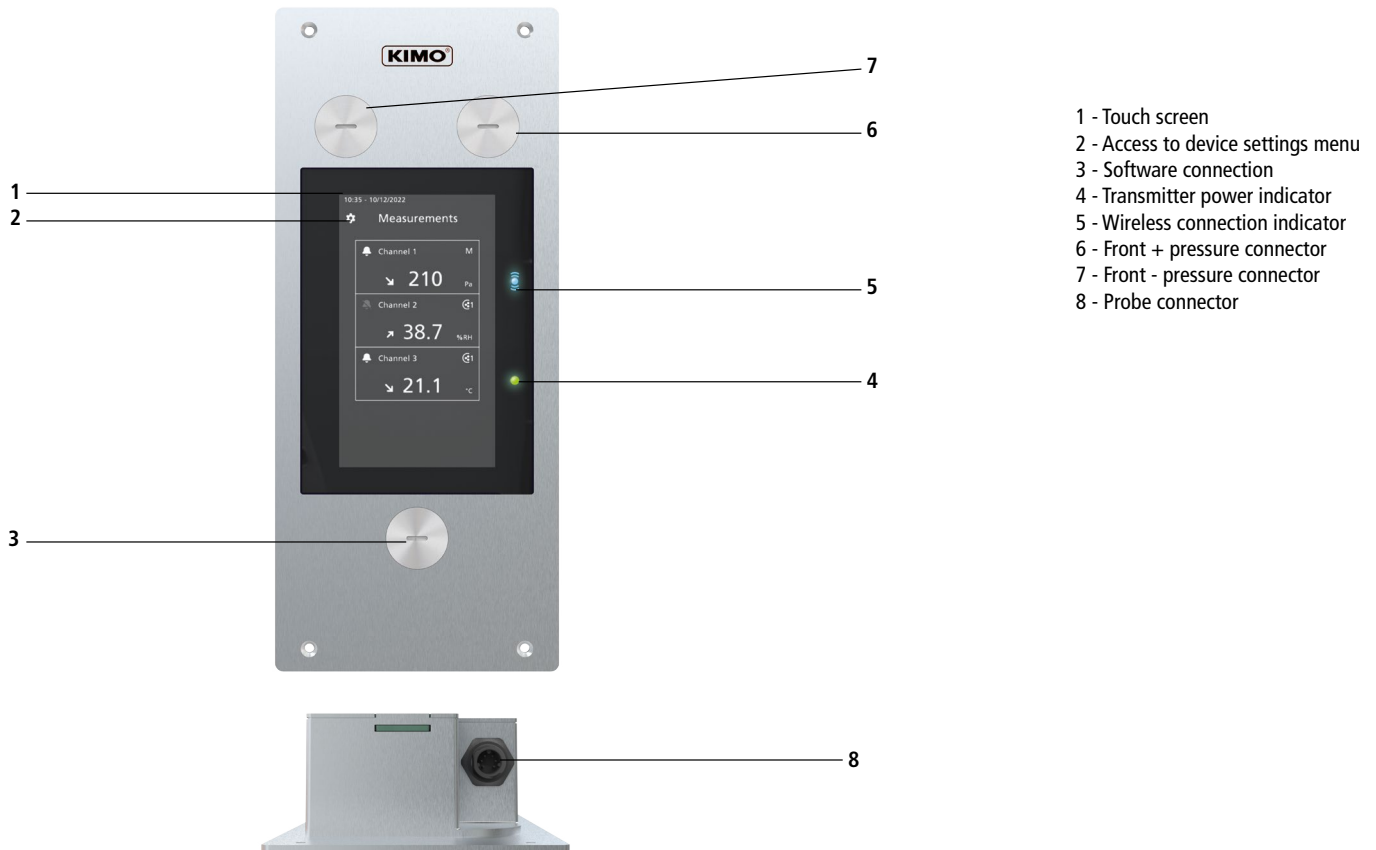

- 1 - Touch screen
- 2 - Access to device settings menu
- 3 - Software connection
- 4 - Transmitter power indicator
- 5 - Wireless connection indicator
- 6 - Front + pressure connector
- 7 - Front - pressure connector
- 8 - Probe connector

3.1.2 Screen description

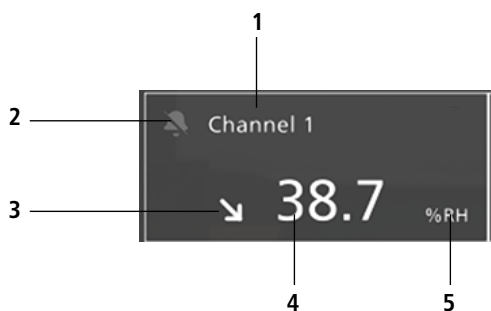

- 1. Channel ID
- 2. Alarm pictogram
- 3. Trend indicator
- 4. Measured value
- 5. Unit of the measured value

Trend indicator: on the screen, a trend indicator represented by a rising arrow, a going down arrow or a stable arrow is displayed on the left of the measurement unit. It means the calculation of a moving average on the last hour (M1) to compare with a moving average on the last 5 minutes (M2):

- If $M1 = M2$, the trend is stable.
- If $M1 < M2$, the trend is upwards.
- If $M1 > M2$, the trend is downward.

This trend indicator is displayed after 5 minutes.

Alarm pictogram: on the screen, an alarm pictogram is displayed for each channel. Two different pictograms can be displayed:



There is no alarm configured and activated for the channel



An alarm is configured and activated for the channel

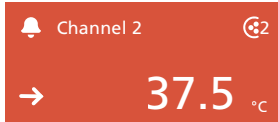

In case of alarm, the background of the channel concerned by the alarm turns red on the screen.

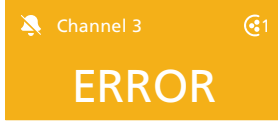

In case of error, the concerned channel's background will change to orange. By tapping on the screen a message with additional information about the problem is displayed.

3.2 Connections

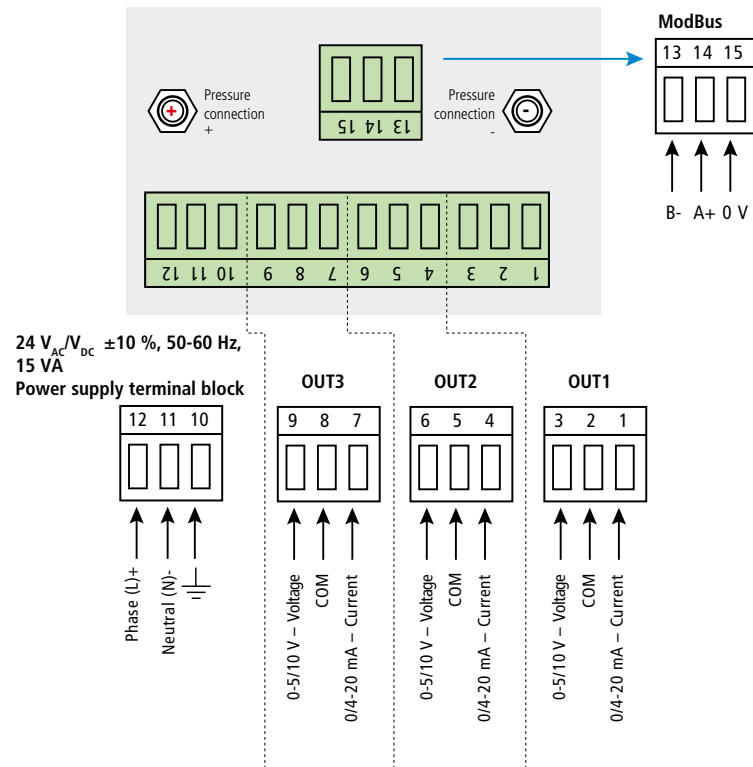

4. Mounting



The transmitter must be mounted before any wire connections.
The transmitter must not be powered before mounting it.

To install the transmitter on a wall:

- Make a cutting of 200 x 82 mm in the wall.
- Drill 4 holes around the cutting as shown below.
- Insert the transmitter into the wall.
- Fix it with the 4 screws (supplied with the transmitter).



The fixing screw is in a plastic bag into the box of the Si-CPE320. Type of screw: Cruciform screw
Ø 3.5 x 12 mm

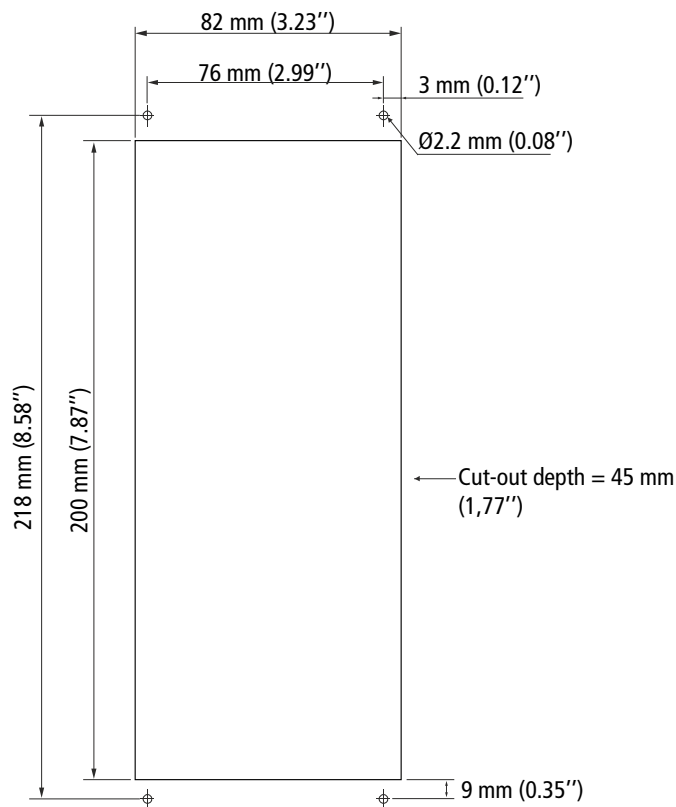

To ensure a proper isolation of the rear side of the instrument,, use sealant of silicone type between the wall and the transmitter. If VHP (Vaporized hydrogen peroxide) is used, check that the seal is VHP resistant.

5. Electrical connections



Electrical connections are as per NF C 15-100 standard.



This connection must be made by a formed and qualified technician. Whilst making the connection, the transmitter must not be energized. The presence of a switch or a circuit breaker upstream the device is compulsory.

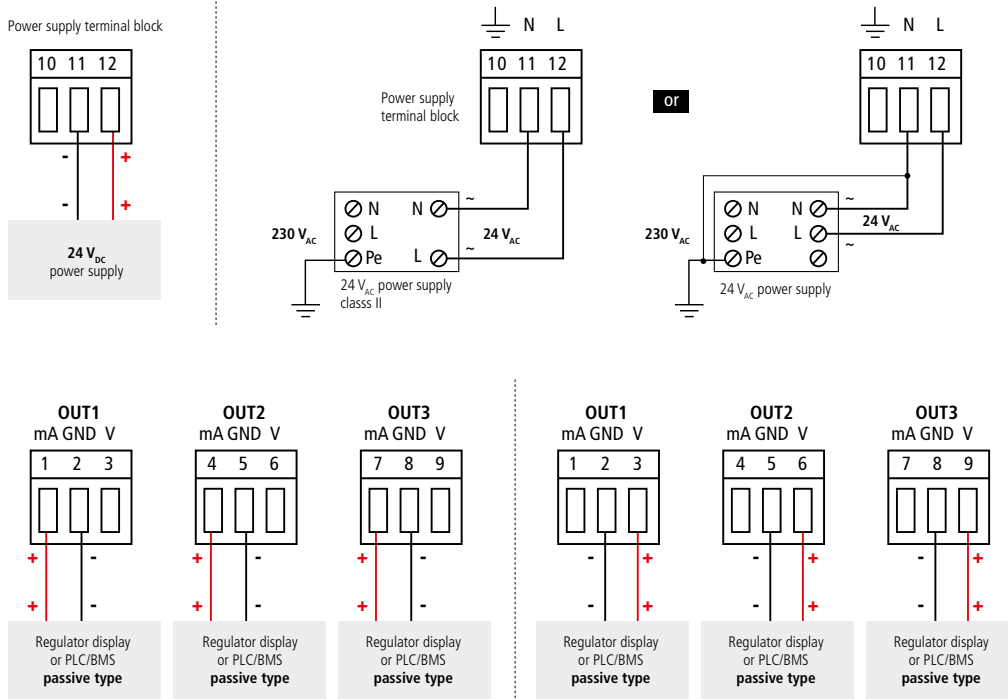

6. First Start-up

When the transmitter is first started up, parameters of the transmitter must be set.

6.1 Set the transmitter

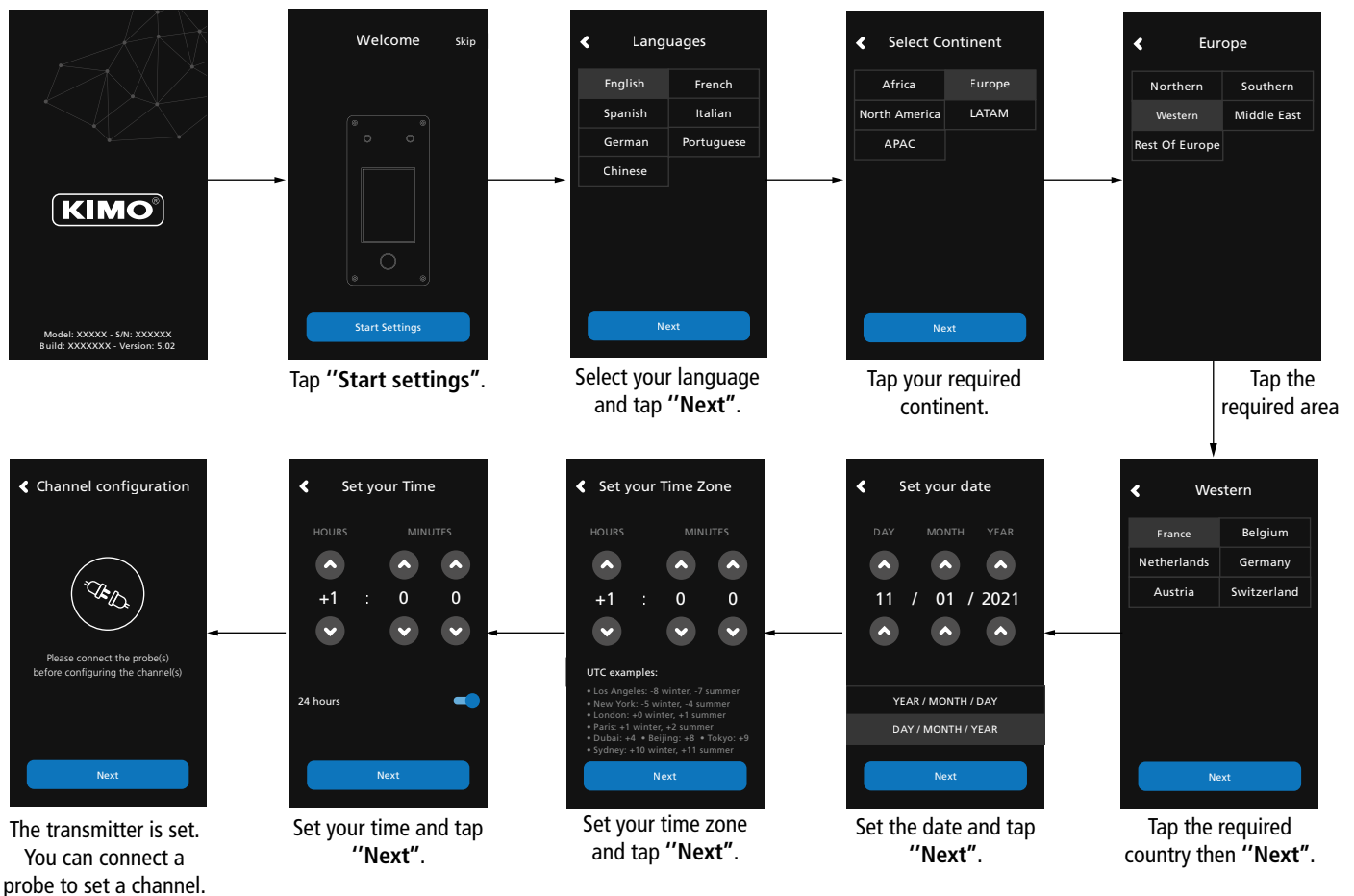

Download Sauer mann Control App

6.2 Connect a probe

- After removing the protection cap on the transmitter connector, present the probe connector (a) with its arrow and padlock face to the transmitter connector (b).
- Push in the probe connector (a) into the transmitter connector (b) until you hear a click. The probe is correctly connected.

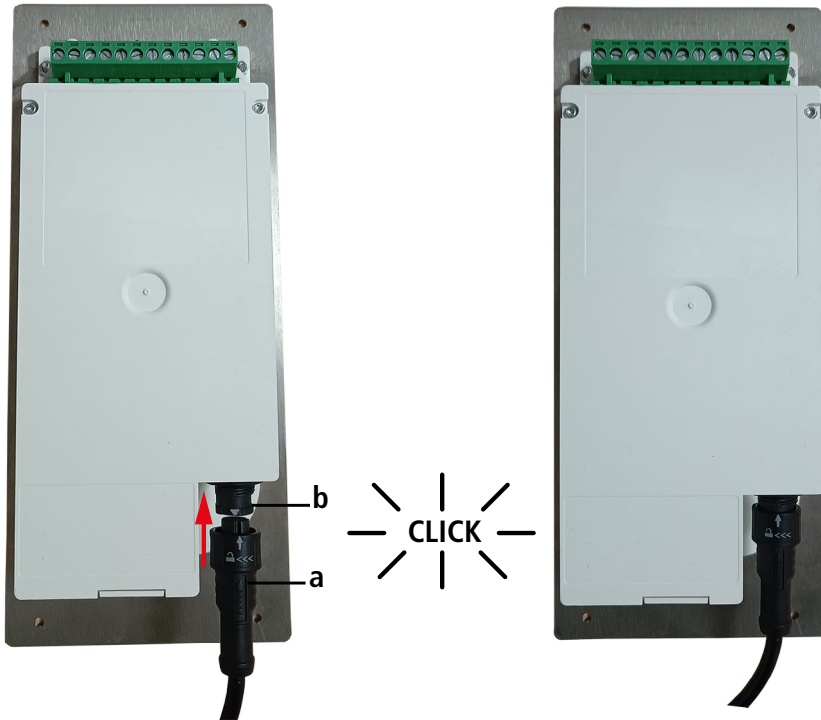

Important information about the Si-PRO-V-300 air velocity probe: always use the air velocity probe with the white arrow (c) facing the air flow.



6.3 Set a channel

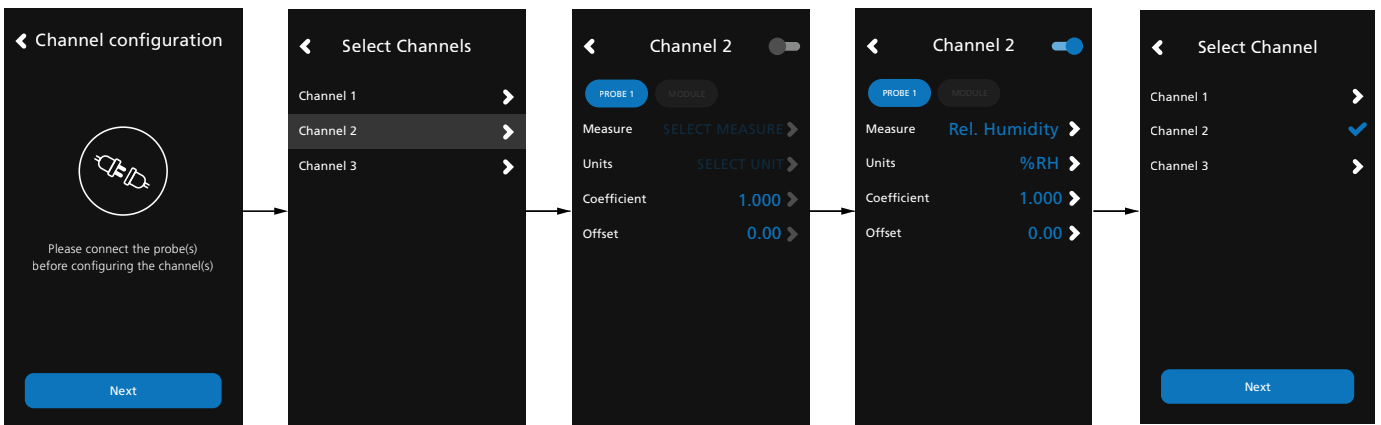

Connect a probe to set a channel and tap "Next".

The list of available channel is displayed. Tap the required channel.

Tap "PROBE 1" or "MODULE". Parameters to set are now available.

Set the parameters according to your needs then tap the back arrow on the top left.

Channel two is configured. Tap next to configure outputs.



Download Sauer mann Control App

6.4 Set an output

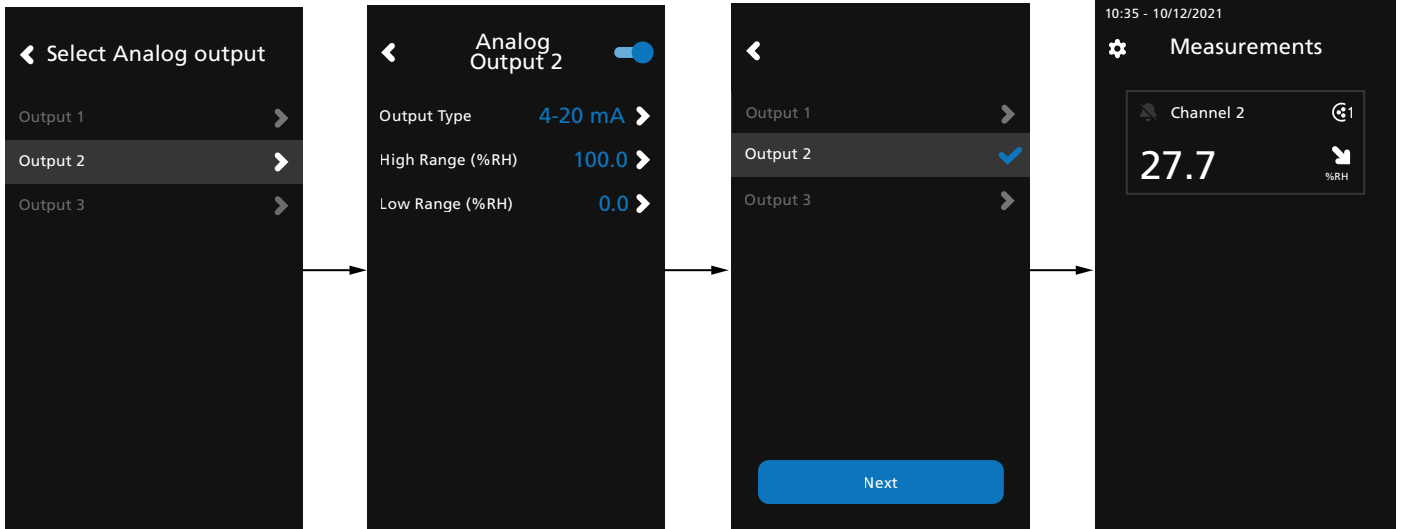

Tap the output to set corresponding to the previously configured channel.

Activate the output tapping . Set the output type and high and low range values then tap the back arrow on the top left.

Tap "Next" to display measures.



Download Sauer mann Control App

6.5 Disconnect a probe

- Turn the ring (c) of the probe connector to the left.
- Pull the probe connector (a) away from the transmitter connector (b).

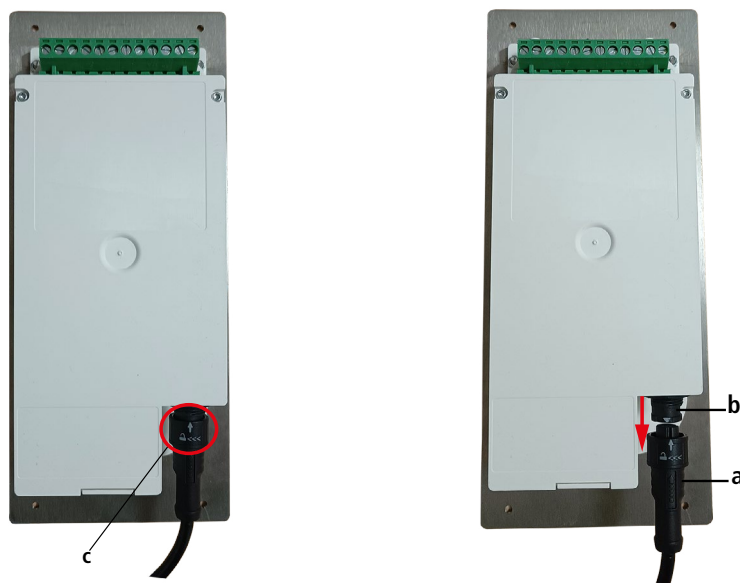

7. Transmitter features

7.1 General features

| | |
|---|--|
| Power supply | 24 V _{AC} / V _{DC} ±10% Warning: risk of electric shock  |
| Outputs | 3 x 0/4-20 mA or 3 x 0-5/10 V (4 wires) Common mode voltage Maximum load: 500 Ω (0/4-20 mA) Minimum load: 1 KΩ (0-5/10 V) |
| Galvanic isolation | On the output |
| Consumption with probe and without option | 15 VA |
| Electrical connections | Screw terminal block for cables from 0.05 to 1.5 mm ² or from 30 to 16 AWG Carried out according to the code of good practices |
| Communication RS485 | Modbus RTU protocol, configurable communication speed from 2400 to 115,200 Bauds |
| Wireless communication (option) | Range frequency from 2402 MHz to 2480 MHz with a transmission power of 0 dBm. Range up to 15 m (50 ft), depending on smartphone radio strength. Minimum required versions: Android 5.0, iOS 12.4, BLE 4.0 |
| Audible alarm | Buzzer (60 dB at 10 cm) |
| Environment and type of fluid | Air and neutral gases |
| Conditions of use (°C/%RH/m) | From -10 to 50 °C (14 to 122 °F) In non-condensing condition From 0 to 2000 m (0 to 6561') |
| Storage temperature | From -10 to 70 °C (14 to 158 °F) |
| Security | Protection class 2 - Pollution degree 2 - Overvoltage category 2 |
| European directives | 2014/30/EU EMC - 2014/35/EU Low Voltage - 2014/53/EU (RED) - 2015/863 EU (RoHS 3) - 2012/19/EU WEEE |

7.2 Features of the housing





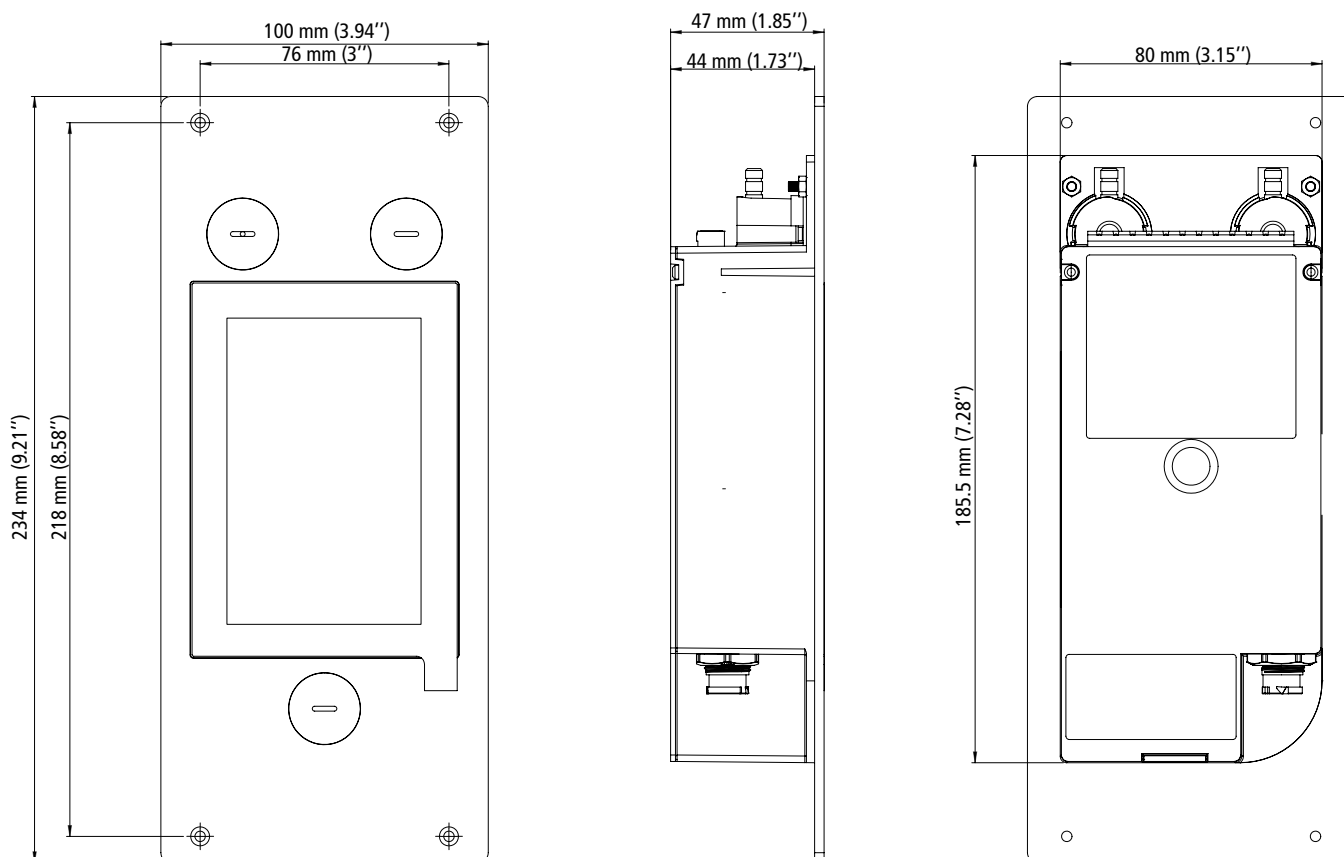

| | |
|----------------------|---|
| Front face | Brushed stainless steel 316 L |
| Back housing | ABS V0 |
| Protection | IP66 in front face, resistant against VHP |
| Display | Graphic touchscreen Size: 480 x 272 pixels |
| Height of the digits | 14 mm (0.56") |
| Back fittings | Barbed fitting Ø 5.2 mm (Ø 0.2") |
| Weight | 684.4 g (1.5 lb) |

7.3 Dimensions



7.4 Possible optional measurements

The following probes and modules are available as an option for Si-CPE320 transmitters. For further details please see the probes technical data sheet for class 320 transmitters.

| Probes / modules | Measuring ranges | Calculated parameters |
|---|---|--|
|  Relative humidity / temperature probe | 0 to 100 %RH and -40 to 150 °C (-40 to 302 °F) (according to the probe) | Dew point: -50 to 100 °C _{td} (-58 to 212 °F _{td}) Wet-bulb temperature: -50 to 100 °C _{tw} (-58 to 212 °F _{tw}) Frost point: -50 to 100 °C _{tf} (-58 to 212 °F _{tf}) Enthalpy: 0 to 15,000 kJ/kg Absolute humidity: 0 to 1000 g/m ³ Mixing Ratio: 0 to 1000 g/kg |
|  Temperature probe | -80 to 150 °C (-112 to 302 °F) | N/A |
|  Air velocity / temperature probe | 0 to 30 m/s (0 to 98.4 fps) and 0 to 50 °C (32 to 122 °F) | Air flow: 0 to 999,999 m ³ /h (0 to 588,577 cfm) Air change rate: 0 to 1000 ACH |
|  CO probe | 0 to 500 ppm | N/A |
|  CO ₂ probe | 0 to 10,000 ppm | N/A |
|  VOC probe | TVOC: 0 to 1000 ppb CO ₂ eq: 400 to 2000 ppm | N/A |

8. Set the transmitter

"Device Settings" menu allows to set the following items for the transmitter:

- Language
- Country
- Date, time and time zone
- Brightness

To access this menu:

- Tap  on the measurement screen.
- Enter the security code.

 Default security code is **0101**. This code can be modified in "**Security/Connectivity**" menu. See chapter 9.2 on page 24.

- Tap "**Device Settings**".

8.1 Set the language

"Device settings" menu is displayed.

- Tap "**Languages**".
- Tap the requested language.

 Available languages: English, French, Spanish, Italian, German, Portuguese and Chinese.

8.2 Set the country

"Device settings" menu is displayed.

- Tap "**Country**".
- Select the continent.
- Select the country.

8.3 Set the date, time zone and time

"Device settings" menu is displayed.

- Tap "**Date, Time Zone, ...**".
- Tap "**Date**", "**Time**" or "**Time zone**" depending on the settings to be made.
- Perform the settings.

8.4 Set the brightness

"Device settings" menu is displayed.

- Tap "**Brightness**".
- Adjust the brightness of the screen from 1 to 5.
- Tap the back arrow on the top left of the screen to back to "**Device Settings**" menu.

9. Set inputs and outputs

"I/O Configurations" menu allows to set the following items:

- **Channels:** activate and set the probes and modules connected to the transmitter
- **Outputs:** activate and set outputs corresponding to the channels
- **Probes and Modules:** define normative values according to probes and modules connected to the transmitter and define some parameters linked to probes and modules
- **Alarms:** activate and set alarm features
- **Autozero:** activate and set the pressure autozero interval

To access this menu:

- Tap  on the measurement screen.
- Tap the security code.

 Default security code is **0101**. This code can be modified in "**Security/Connectivity**" menu. See chapter 9.2 on page 24.

- Tap "**I/O Configurations**".

9.1 Set the measurement channels

"I/O Configurations" menu is displayed.

- Tap "**Channels**".
- Tap the desired channel number (Channel 1, 2 or 3).
Features of the channel are displayed.
- Tap "**PROBE 1**" or "**MODULE**" according to the required attribution for the channel.
"Measures" becomes available.
- Tap "**Measures**".
- Select the required parameter then tap the back arrow on the top left of the screen.
- Tap "**Units**".
- Select the required measurement unit then tap the back arrow on the top left of the screen.
The channel is automatically activated (toggle switch is on).
- If required, enter a coefficient and an offset to the channel.
- Tap the back arrow on the top left of the screen until measurement screen is displayed.
Values measured by the probe or the module are displayed.



Special case: two units are available for the VOC probe: ppb and ppm CO₂ equivalent. If ppm is selected, the transmitter will take 15 minutes to display the first measurements (pre-heating phase).



The channel name can be changed:

- Tap  next to the channel name to edit it.
- Enter a name. Maximum characters: 13.
- Tap OK to validate.

9.2 Set the outputs

Two types of outputs are available: analog outputs and digital outputs

9.2.1 Set the analog outputs



At least one measurement channel must be configured. If no channel has been configured, no analog output will be delivered.

"I/O Configurations" menu is displayed.

- Tap "Outputs".
- Tap "Analog Outputs".
- Tap the desired output (Output 1, 2 or 3 depending on the number of the previously configured channel).
Features of the output are displayed.
- Tap  on the top right of the screen to activate the output
- Tap "Output type".
- Select the output type: 0-5 V, 0-10 V, 0-20 mA or 4-20 mA then tap the back arrow on the top left of the screen.
- Tap "High range".
- Define the high range value for the output then tap the back arrow on the top left of the screen.
- Tap "Low range".
- Define the low range value for the output then tap the back arrow on the top left of the screen.

9.2.2 Perform an output diagnostic

This function allows to check on a measurement device (multimeter, regulator or automate) the proper functioning of the outputs. The transmitter will generate a voltage (between 0 and 10 V) or a current (between 0 and 20 mA) according to the setting of the type of output.

- For a 0-10 V output signal, the transmitter will generate 0 – 5 or 10 V.
- For a 0-5 V output signal, the transmitter will generate 0 – 2.5 or 5 V.
- For a 4-20 mA output signal, the transmitter will generate 4 – 12 or 20 mA.
- For a 0-20 mA output signal, the transmitter will generate 0 – 10 or 20 mA.



Before carrying out the output diagnostics, all connections and configurations of the transmitter must be enabled, to avoid any damage on the transmitter and the measurement device.

- Select an output for the output diagnostic.
- OUT1, OUT2 or OUT3 indicated on the connection label.
- Connect a measurement device on the channel 1, 2 or 3.

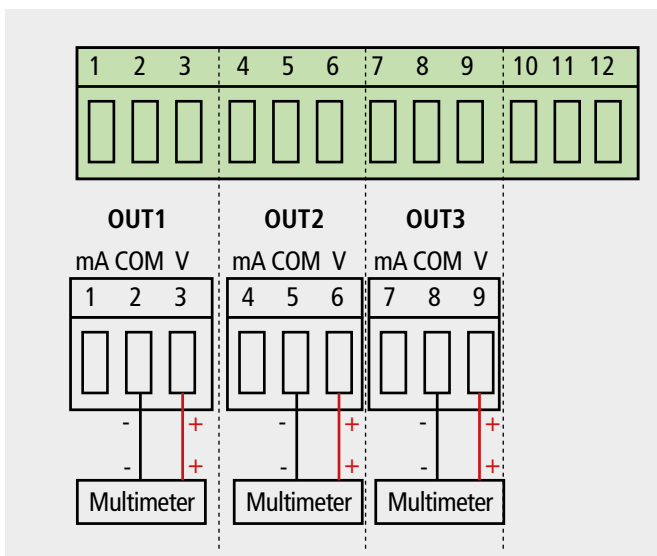

Connection of the 0/10 V voltage output

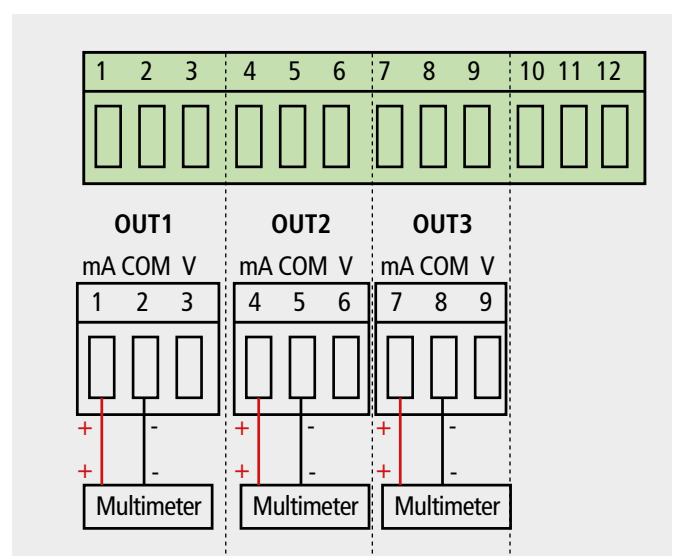

Connection of the 0/4-20 mA current output

Once the connection to the measurement device is complete, the output diagnostic on several check points can be performed:

"I/O Configurations" menu is displayed.

- Tap "Outputs".
- Tap "Analog Outputs".
- Tap "Diagnostic" line.

- Tap the required value.

 The values proposed will depend on the type of output previously selected. For example, if the output type is 4-20 mA, proposed values will be 4 mA, 12 mA and 20 mA.

 **If the deviations are too large (> 0.05 V or > 0.05 mA) between the signal issued and the value displayed on the multimeter, we recommend that you return the transmitter to our factory.**

9.2.3 Set the digital output (Modbus RTU)

"I/O Configurations" menu is displayed.

- Tap "Outputs".
- Tap "Digital Outputs".
Features of Modbus are displayed.
- Tap "Slave address".
- Define the slave address number between 1 and 255 then tap the back arrow on the top left of the screen.
- Tap "Baud rate".
- Select the baud rate between 2400, 4800, 9600, 19,200, 38,400, 57,600, 76,800 and 115,200 then tap the back arrow on the top left of the screen.

 Default baud rate: 9600

9.3 Set the probes and the pressure module

This menu allows to define relevant values related to the probes and the pressure module connected to the transmitter and define some parameters linked to them:

- **For an air velocity probe (hotwire probe):** duct dimensions and type of section, the correction factor, the integration in air velocity and the compensation in atmospheric pressure for airflow calculation.
- **For the pressure module:** for air velocity and airflow calculation the duct dimensions and type of section, the airflow coefficient, the pressure probe coefficient, the integration in pressure and autozero duration.
- **For a CO₂ probe:** the compensation in atmospheric pressure
- **For an hygrometry probe:** the compensation in atmospheric pressure for the psychrometry calculations

9.3.1 Normative values

For the airflow calculations, it is possible to convert the value into normative values (ex: Nm³/h).

The conversion can be done according to two standards:

- DIN 1343: 1013.325 hPa, 273,15 K (0°C)
- ISO 2533: 1013.325 hPa, 288,15 K (15°C)

"I/O Configurations" menu is displayed.

- Tap "Probes & Modules".
The screen displays the connected probes and modules.
- Tap "Normative values".
- Select the normative value according to your needs: DIN 1343 or ISO 2533 then tap the back arrow on the top left of the screen.

9.3.2 Configure the compensation of a CO₂ or hygrometry probe

 **A CO₂ or hygrometry probe must be connected to the transmitter.**

Set the compensation in atmospheric pressure:

"I/O Configurations" menu is displayed.

- Tap "Probes & Modules".
The screen displays the connected probes and modules.
- Tap the line corresponding to the temperature/hygrometry probe or to the CO₂ probe.
- Tap "Atmo pressure".

- Tap **"Unit"** to select the atmospheric pressure unit.
- Tap **"Atmo pressure"** to enter a value. This value must be between:
 - 0 and 4000 hPa
 - 0 and 4000 mbar
 - 0 and 3000.24 mmHg
 - 0 and 10 000 m (altitude)

9.3.3 Configure the differential pressure module

Select the measuring device:

"I/O Configurations" menu is displayed.

- Tap **"Probes & Modules"**.
The screen displays the connected probes and modules.
- Tap the line corresponding to the pressure module.
- Tap **"Device"**.
- Tap **"Type"**.
- Tap the desired measurement mean between:
 - Pitot tube L (coefficient: 1.0015)
 - Pitot tube S (coefficient: 0.84)
 - Debimo blades (coefficient: 0.8165)
 - Other (free coefficient)

 If **"Other"** is selected, the coefficient of the other measurement mean should be entered. This coefficient must be between 0.0001 and 9.9999.

- Tap the back arrow on the left of the screen to back to configuration menu.

Select the type of duct section:

"I/O Configurations" menu is displayed.

- Tap **"Probes & Modules"**.
The screen displays the connected probes and modules.
- Tap the line corresponding to the pressure module.
- Tap **"Section"**.
- Tap **"Shape"**.
- Tap the requested section:
 - Rectangular
 - Circular
 - Custom coefficient

For a rectangular section:

- Tap **"Unit"** to select the unit: mm or in, then tap the back arrow on the top left of the screen.
- Enter the length and width of the section.

 Length and width of the section must be between 1 and 3000 mm (0.039 to 118.11 in).

For a circular section:

- Tap **"Unit"** to select the unit: mm or in, then tap the back arrow on the top left of the screen.
- Enter the diameter.

 Diameter of the section must be between 1 and 3000 mm (0.039 to 118.11 in).

For a custom coefficient (airflow coefficient):

- Tap "**Coefficient**" to enter an airflow coefficient, then tap the back arrow on the left of the screen.

This airflow coefficient allows to calculate an airflow from the pressure. It is indicated by the manufacturer of the devices supplied with pressure connections (+ and -). From the square root of the measured pressure (Delta P) and from this coefficient, you get the airflow. $Airflow = C_d \times \sqrt{\Delta P}$



The coefficient must be between 0.1 and 9999.9.

Set the compensation in temperature:

It is possible to modify the compensation temperature value. Indeed, the measured value of air velocity and airflow with a Pitot tube or Debimo blades (or other differential pressure element) depends on the operating temperature. It is required to enter the operating temperature in order to get more accurate results. It is possible to enter the value manually, to use the temperature value from a connected temperature probe to the transmitter or to use the temperature measured by an internal sensor for an automatic temperature compensation.

"I/O Configurations" menu is displayed.

- Tap "**Probes & Modules**".
The screen displays the connected probes and modules.
- Tap the line corresponding to the pressure module.
- Tap "**Temperature**".
- Tap "**Source**" to select the temperature source between:
 - Internal sensor
 - Manual: enter manually a temperature: press "**Manual**" then select the unit (°C or °F) then tap "**Temperature**" to enter a value between -50 and 50 °C.
 - Probe 1: the transmitter will take into account the measured temperature by a temperature probe connected to the transmitter at the "Probe 1" location.

Set the compensation in atmospheric pressure:

"I/O Configurations" menu is displayed.

- Tap "**Probes & Modules**".
The screen displays the connected probes and modules.
- Tap the line corresponding to the pressure module.
- Tap "**Atmo pressure**".
- Tap "**Unit**" to select the atmospheric pressure unit.
- Tap "**Atmo pressure**" to enter a value. This value must be between:
 - 0 and 4000 hPa
 - 0 and 4000 mbar
 - 0 and 3000.24 mmHg
 - 0 and 10 000 m (altitude)

Enter an integration in pressure:

"I/O Configurations" menu is displayed.

- Tap "**Probes & Modules**".
The screen displays the connected probes and modules.
- Tap the line corresponding to the pressure module.
- Tap "**Integr. & Correction**".
- Tap "**Integration**".
- Enter the integration then tap the back arrow on the top left of the screen.



The pressure integration must be between 0 and 9.

Enter a correction factor:

The correction factor allows to adjust the transmitter according to data in air velocity of the installation.

How to calculate it? For example, the air velocity in your section is 17 m/s and the transmitter displays 16.6 m/s.

The coefficient to apply is 17 / 16,6, it means 1.024.

"I/O Configurations" menu is displayed.

- Tap "Probes & Modules".
The screen displays the connected probes and modules.
- Tap the line corresponding to the pressure module.
- Tap "Integr. & Correction".
- Tap "Correction factor".
- Enter the correction factor then tap the back arrow on the top left of the screen.



The correction factor must be between 0 and 9.

9.4 Set the alarms

This part allows to activate and define the alarms conditions on one or several channels.



One channel must be configured at least (see chapter 8.1 on page 17)

If no channel has been configured, the alarm corresponding to the channel will be not available.

9.4.1 Set the alarm thresholds

"I/O Configurations" menu is displayed.

- Tap "Alarms".
The screen displays the alarm available.
- Tap the line of the alarm to configure.
- Tap "Threshold up" to enter and validate the high threshold then tap the back arrow on the top left of the screen.
- Tap "Threshold down" to enter and validate the low threshold then tap the back arrow on the top left of the screen.
- Tap  on the top right of the screen to activate the alarm.

9.4.2 Set the alarms parameters

It's then possible to set the parameters of the alarm: Time delay, Hysteresis, Acoustic alarm and Acknowledgement.

"I/O Configurations" > "Alarm" menu is displayed.

Set the time delay:

Time Delay: this is the time in seconds before the alarm is triggered when the measurement exceeds the threshold or is below the threshold.

Example: time delay set to 5 s. The alarm will be triggered when the threshold is exceeded for 5 s or more or when the measurement is below the threshold for 5 s or more.

- Tap "Alarm parameters".
- Tap "Time delay".
- Enter the time delay in second.



The time delay must be between 0 and 600 s.

Set the hysteresis:

Hysteresis: hysteresis value impacts the return to normal state. Example for an alarm with a high threshold at 80 Pa, a low threshold at 20 Pa and a hysteresis at 5 Pa: the alarm stay triggered until the value goes below 75 (or up to 25).

- Tap "Alarm parameters".
- Tap "Hysteresis".
- Enter the hysteresis.



The hysteresis must be between the low threshold and the high threshold (only if two thresholds are configured).

Set the alarm acknowledgement

Alarm acknowledgement: when an alarm goes off, it is possible to acknowledge it by pressing the value in alarm on the screen: the audible alarm, if activated, turns off and the displayed value remains in red during the acknowledgement duration. At the end of the acknowledgement duration, if the transmitter is still in alarm state, the audible alarm is reactivated.

- Tap "**Alarm parameters**".
- Tap "**Acknowledge**".
- Enter the alarm acknowledgement in minute.



The acknowledgement duration must be between 0 and 60 min.

9.5 Set the autozero

Enter the interval between two autozeros: thanks to the temperature compensation of the gain (from 0 to 50°C / 14 à 122 °F) and to the autozero system, Class 320 transmitters guarantee an excellent long-term stability, along with a great measurement accuracy.

Autozero principle: the microprocessor drives a solenoid valve that compensates for any long-term drift of the sensitive element.

Compensation is made by regular automatic adjustment of the zero. True differential pressure measurement is then made regardless of the environmental conditions of the transmitter.

"**I/O Configurations**" menu is displayed.

- Tap "**Autozero**".
- Tap "**Autozero interval**".
- Enter the autozero interval in minute.



The autozero interval must be between 10 and 60 min.

The autozero is managed by a solenoid valve. The behaviour of this solenoid valve is linked to the ambient temperature. An automatic monitoring of the internal temperature of the device ensures the correct operation of the solenoid valve.

When starting the device or when the solenoid valve is activated for the first time, the solenoid valve is automatically triggered for 30 seconds (160 seconds if the internal temperature of the device is lower than 0 °C/32 °F) if the internal temperature of the device is higher than 0 °C/32 °F.

During the first 20 minutes, the solenoid valve is automatically triggered to perform an autozero every 3 minutes. Between 20 minutes and 60 minutes, the solenoid valve is automatically triggered to perform an autozero every 10 minutes.

After the first hour of operation, the device will perform an autozero according to the user's configuration.

If the internal temperature of the device falls below 1 °C/34 °F, the solenoid valve is automatically activated every 30 minutes. The autozero is not taken into account during this operation.

10. Security and connectivity

This part allows to manage the wireless communication, to define the security code and the touch lock functionality.

To access this menu:

- Tap  on the measurement screen.
- Tap the security code.



Default security code is **0101**. This code can be modified in "**Security/Connectivity**" menu. See chapter 9.2 on page 24.

10.1 Wireless communication

It's possible to activate and deactivate the wireless communication. The wireless communication must be activated to use the Sauermann Control app.

"**Security/Connectivity**" menu is displayed.

- Tap  to activate the wireless communication.

or

- Tap  to deactivate the wireless communication.

10.2 Define the security code

To configure the transmitter, and for security purposes, a security code must be entered. The default code is 0101.

This code can be modified:

"**Security/Connectivity**" menu is displayed.

- Tap "**Security code**".
- Tap "**New code**".
- Enter a new code of 4 digits then tap OK.
- Tap "**Confirmation**".
- Confirm the new code then tap OK.
- Tap "**Save code**" button.

10.3 Define the Touch Lock functionality

It's possible to lock the screen of the transmitter after a certain time of non-use. To unlock it, tap the lock icon for 3 seconds.

"**Security/Connectivity**" menu is displayed.

- Tap "**Touch lock**".
- Tap "**Lock delay**".
- Enter the lock delay then tap OK.
- Tap  to activate the touch lock.

10.4 Reset instrument from factory

It's possible to reset the transmitter to factory parameters.

"**Security/Connectivity**" menu is displayed.

- Tap "**Reset Instrument From Factory**".
The transmitter displays a message asking if you are sure to back to factory settings.
- Tap Yes to confirm the reset.

or

- Tap the back arrow on the top left of the screen to cancel.



The transmitter will be reset to original delivery settings. All your configurations will be deleted.
Units and values of measurement settings of the factory setting:

| Feature | Default value |
|--|----------------------|
| Channel N output | Output type 4-20 mA |
| Channel N range | N/A |
| Channel N's name | Channel N |
| Alarms | Off |
| Display brightness | 5 |
| Graph timespan | 24 hours |
| Wireless communication | On |
| Access code to enter the configuration menu | 0101 |
| Modbus output | Off |
| Modbus address | 1 |
| Modbus baud rate | 9600 bps |
| Date and time | Last set value |
| Device's time zone | Last set value |
| Correction coefficients | None |
| ΔP element for Air flow/Air velocity calculation | None |
| Duct size/conversion factor | None |
| Autozero of the differential pressure sensor | 10 minutes |
| Pressure integration | 0 |
| Air flow/Air velocity standardized value | No |
| Air flow/Air velocity compensation temperature | Manual, 20 °C |
| Language | English |
| Time Zone | UTC+1 |

11. Information about transmitter, probes and module

"**Information**" menu allows to access to information such as serial numbers, firmware version, date of last adjustment and calibration, date of next service,...

To access this menu:

- Tap  on the measurement screen.
- Tap the security code.

 Default security code is **0101**. This code can be modified in "**Security/Connectivity**" menu. See chapter 9.2 on page 24.

- Tap "**Information**".

11.1 Instrument, probes and module information

"**Information**" menu is displayed.

- Tap "**Instruments and probes**".
- Tap "**Instruments**" or "**Probes/modules**".

The screen displays the following information:

- Model
- S/N (Serial Number)
- Build
- Firmware version

 In case of a trouble with your device and when contacting the after-sale service or the hotline, this information will be useful.

11.2 Adjustment and calibration information

This menu displays information about adjustment and calibration for probes and modules connected to the transmitter.

"**Information**" menu is displayed.

- Tap "**Adjustment & Calibration**".
- Tap the requested probe or module.
- Tap the requested parameter depending on the probe or module previously selected.

The screen displays the following information:

- Last adjustment date
- Last calibration date
- Date of next service

11.3 Probe update

This menu allows to check if a firmware update is available for probes.

"**Information**" menu is displayed.

- Tap "**Probe Update**".

The screen displays the current probe firmware version. If no update is available, the following message is displayed: "Probes are already running the latest firmware."

The screen displays the current probe firmware version. If an update is available, the following message is displayed: "A new probe firmware is available. Installing the new probe firmware will restart the transmitter. Measurements will neither be collected nor available during this process".

- Tap "**Install**".

The transmitter displays the following message: Updating probe X to x.x.xx (firmware version).



Do not disconnect the probe from the transmitter during this step.

Once the installation of the new firmware is finalized, the transmitter restarts and measurements are displayed.

12. Maintenance and precautions for use

12.1 Maintenance

Please avoid any aggressive solvents. Please protect the transmitter and its probes from any cleaning product containing formalin, that may be used for cleaning rooms or ducts.

12.2 Precautions for use

Please always use the device in accordance with its intended use and within parameters described in the user manual in order not to compromise the protection ensured by the device.

13.1 Configuration of parameters

- Communication speed: between 2400 and 115200 bauds, 9600 bauds by default
- Data bits: 8 bits
- Stop bit: 1 bit
- Parity: None
- Flow control: None
- Transmitter addressing: between 1 and 255 (automatically answers the requests from address 0)
- Data sending: made by words of 2 bytes, in the following order most-significant then least-significant byte

13.2 Functions

- Register function: Function 03
- Register writing: Function 16
- Communication loop test: Function 08

13.3 Data format

| UNIT8 | Byte 1 | Byte 0 (lsb) |
|--------------|--------|--------------|
| Value (0x01) | 0x00 | 0x01 |
| Registers | Reg0 | |
| | 0x00 | 0x01 |

| UNIT16 | Byte 1 | Byte 0 (lsb) |
|----------------|--------|--------------|
| Value (0x0102) | 0x01 | 0x02 |
| Registers | Reg0 | |
| | 0x01 | 0x02 |

| UNIT32 | Byte3 | Byte2 | Byte1 | Byte0 (lsb) |
|--------------------|-------|-------|-------|-------------|
| Value (0x01020304) | 0x01 | 0x02 | 0x03 | 0x04 |
| Registers | Reg0 | | Reg1 | |
| | 0x03 | 0x04 | 0x01 | 0x02 |

| FLOAT32 | Byte3 | Byte2 | Byte1 | Byte0 (lsb) |
|--------------------|-------|-------|-------|-------------|
| Value (0x01020304) | 0x01 | 0x02 | 0x03 | 0x04 |
| Registers | Reg0 | | Reg1 | |
| | 0x03 | 0x04 | 0x01 | 0x02 |

13.4 Enumeration table

13.4.1 Languages enumeration

| Identifier | Language |
|------------|------------|
| 0 | English |
| 1 | French |
| 2 | Spanish |
| 3 | Italian |
| 4 | German |
| 5 | Portuguese |
| 6 | Chinese |
| 7 | Dutch |

13.4.2 Units enumeration

| Identifier | Unit | Identifier | Unit |
|------------|---------------------|------------|---------------------|
| 0 | °C | 29 | t/d |
| 1 | °F | 30 | cm ² |
| 2 | mbar | 31 | in ² |
| 3 | inwg | 32 | m ³ |
| 4 | mmh2O | 33 | cf |
| 5 | mmHg | 34 | %RH |
| 6 | Pa | 35 | kJ/kg |
| 7 | hPa | 36 | m |
| 8 | kPa | 37 | mm |
| 9 | psi | 38 | ft ³ /h |
| 10 | ppm | 39 | in |
| 11 | ppb | 40 | % |
| 12 | mg/m ³ | 41 | ratio |
| 13 | g/m ³ | 42 | °Ctw |
| 14 | % | 43 | °Ftw |
| 15 | mg/kWh | 44 | °Ctd |
| 16 | g/kWh | 45 | °Ftd |
| 17 | g/GJ | 46 | unused |
| 18 | g/bhp-hr | 47 | unused |
| 19 | m/s | 48 | g/kg |
| 20 | fps | 49 | ACH |
| 21 | fpm | 50 | V |
| 22 | km/h | 51 | mA |
| 23 | m ³ /min | 52 | daPa |
| 24 | m ³ /h | 53 | m ³ /s |
| 25 | cfm | 54 | dam ³ /h |
| 26 | ft ³ /h | 55 | l/s |
| 27 | kg/h | 56 | fps |
| 28 | lb/h | | |

13.4.3 Measurements enumeration

| Identifier | Unit | Identifier | Unit |
|------------|----------------------------|------------|----------------------------|
| 0 | Temperature (internal NTC) | 13 | VOC |
| 1 | Temperature (Pt100) | 14 | CO2eq |
| 2 | Relative humidity | 15 | Air flow |
| 3 | Air velocity | 16 | ACR |
| 4 | Pressure (module 50 Pa) | 17 | Mixing ratio |
| 5 | Pressure (module 250 Pa) | 18 | Absolute humidity |
| 6 | Pressure (module 1000 Pa) | 19 | Enthalpy |
| 7 | Pressure (module 10000 Pa) | 20 | Wet bulb temperature |
| 8 | CO | 21 | Atmo pressure |
| 9 | CO ₂ | 22 | Battery level |
| 10 | Temperature (TK) | 23 | Temperature (external NTC) |
| 11 | Dew point | 24 | Vacuum |
| 12 | Frost point | 25 | Air velocity |

13.4.4 Other enumeration

| Identifier | 0 | 1 | 2 | 3 | 4 | 5 | 6 |
|------------|---|---|---|---|---|---|---|
| | | | | | | | |

| | | | | | | | |
|--------------------------------------|------------------------------|----------------|----------------|-----------------|-----------------|---------------|-----------------|
| Graph timespan | 30 minutes | 1 hour | 12 hours | 24 hours | Unused | | |
| Date format | mm/dd/yyyy | dd/mm/yyyy | Unused | | | | |
| Hour format | 12 h | 24 h | Unused | | | | |
| Channel unit | cf. units enumeration | | | | | | |
| Channel measurement | cf. measurements enumeration | | | | | | |
| Channel trend | Down | Equal | Up | Not available | Unused | | |
| Channel error reason | None | Internal | Not configured | Measurement | Unplugged probe | Invalid probe | Probe to update |
| Probe | Probe 1 | Probe 2 | Module | Unused | | | |
| Analogue output | 0-5 V | 0-10 V | 0-20 mA | 4-20 mA | Unused | | |
| Alarm mode | None | Down threshold | Up threshold | Both thresholds | Unused | | |
| Pressure Equipment Type | Pitot tube S | Pitot tube L | Debimo blades | Other | None | Unused | |
| Temperature compensation mode | Use internal sensor | Manual | Use probe 0 | Use probe 1 | Use probe 2 | Unused | |
| Section type | Rectangular | Circular | Other | Not configured | Unused | | |
| Normative values | None | DIN1343 | ISO2533 | Unused | | | |
| Measurement status | Ok | Out of range | Error | Heating | Unused | | |

13.5 Description of function and Modbus connections

13.5.1 Device

| Modbus | Register type | Description | Possibilities |
|--------|---------------|----------------------------------|--|
| 1000 | STR | Serial number of the transmitter | 12 characters |
| 1010 | STR | Firmware version | |
| 1020 | STR | Device identification | |
| 1030 | STR | Probe 1 identification | |
| 1040 | STR | Probe 2 identification | |
| 1050 | STR | Module identification | |
| 1060 | STR | Probe 1 serial number | |
| 1070 | STR | Probe 2 serial number | |
| 1080 | STR | Module serial number | |
| 1090 | STR | Probe 1 version | |
| 1100 | STR | Probe 2 version | |
| 1110 | STR | Module version | |
| 1120 | U8 | Backlit value | In percent, from 0 to 100. |
| 1150 | U8 | Graph timespan | Time zone offset relative to UTC/GMT in seconds |
| 1160 | U8 | Graph selected channel | 0-indexed channel identifier |
| 1200 | U8 | Language | cf. languages enumeration |
| 1300 | U32 | Timestamp | The number of seconds that have elapsed since January 1, 1970 (midnight UTC/GMT) |
| 1310 | U32 | Time offset | Time zone offset relative to UTC/GMT in seconds |

| | | | |
|------|---------|--|---|
| 1320 | U8 | Date format | 0: mmddyyyy, 1: ddmmyyyy (where dd is day, mm is month, yyyy is year) |
| 1330 | U8 | Hour format | 0: 12 h, 1: 24 h |
| 1350 | BOOLEAN | Sound | 0: deactivated, 1: activated |
| 1400 | BOOLEAN | Keypad locking | 0: unlocked, 1: locked |
| 1410 | U16 | Safety code | Safety code string converted in digital value (ex: 1234 for code = '1' '2' '3' '4') |
| 1500 | U8 | Modbus slave number | Slave address of the device in Modbus network from 1 to 247 |
| 1510 | U32 | Modbus speed communication | 2400 / 4800 / 9600 / 19200 / 38400 / 57600 / 76800 / 115200 bds |
| 1710 | BOOLEAN | Activation of the Modbus option | 0: deactivated, 1: activated |
| 1900 | BOOLEAN | Back to factory configuration | 1: Launch factory reset |
| 1910 | U8 | Delay time (in min) between 2 auto-zeros | From 10 to 60. |
| 1920 | BOOLEAN | Instantaneous autozero | 1: launch instantaneous autozero |

13.5.2 Channels

| Modbus | Register type | Description | Possibilities |
|--------|---------------|---------------------------------|---|
| 2000 | U8 | Unit selection of the channel 1 | cf. units enumeration table |
| 2010 | U8 | Selection of probe or module | 0: probe1, 1: probe2, 2: module |
| 2020 | U8 | Selected measure | cf. measures enumeration table |
| 2030 | I8 | Measure resolution | Number of digits after comma. |
| 2040 | F32 | Channel 1 coefficient | This value must be between 0.1 and 2.0 |
| 2050 | F32 | Channel 1 offset | This value must be between 0.0 and 10.0 |
| 2100 | U8 | Unit selection of the channel 2 | cf. units enumeration table |
| 2110 | U8 | Selection of probe or module | 0: probe1, 1: probe2, 2: module |
| 2120 | U8 | Selected measure | cf. measures enumeration table |
| 2130 | I8 | Measure resolution | Number of digits after comma. |
| 2140 | F32 | Channel 2 coefficient | This value must be between 0.1 and 2.0 |
| 2150 | F32 | Channel 2 offset | This value must be between 0.0 and 10.0 |
| 2200 | U8 | Unit selection of the channel 3 | cf. units enumeration table |
| 2210 | U8 | Selection of probe or module | 0: probe1, 1: probe2, 2: module |
| 2220 | U8 | Selected measure | cf. measures enumeration table |
| 2230 | I8 | Measure resolution | Number of digits after comma. |
| 2240 | F32 | Channel 3 coefficient | This value must be between 0.1 and 2.0 |
| 2250 | F32 | Channel 3 offset | This value must be between 0.0 and 10.0 |

13.5.3 Outputs

| Modbus | Register type | Description | Possibilities |
|--------|---------------|--|---|
| 3000 | U8 | Analog output selection of the channel 1 | 0 : 0-5 V, 1 : 0-10 V, 2 : 0-20 mA, 3 : 4-20 mA |
| 3100 | U8 | Analog output selection of the channel 2 | 0 : 0-5 V, 1 : 0-10 V, 2 : 0-20 mA, 3 : 4-20 mA |

| | | | |
|------|-----|--|---|
| 3200 | U8 | Analog output selection of the channel 3 | 0 : 0-5 V, 1 : 0-10 V, 2 : 0-20 mA, 3 : 4-20 mA |
| 3010 | F32 | Channel 1 diagnostic: generation of a current or a voltage | This value must be between 0.0 and 1.0 |
| 3110 | F32 | Channel 2 diagnostic: generation of a current or a voltage | This value must be between 0.0 and 1.0 |
| 3210 | F32 | Channel 3 diagnostic: generation of a current or a voltage | This value must be between 0.0 and 1.0 |
| 3310 | F32 | Channel 4 diagnostic: generation of a current or a voltage | This value must be between 0.0 and 1.0 |
| 3020 | F32 | Channel 1 minimum range | Depends on the connected probe and the measure type |
| 3030 | F32 | Channel 1 maximum range | Depends on the connected probe and the measure type |
| 3120 | F32 | Channel 2 minimum range | Depends on the connected probe and the measure type |
| 3130 | F32 | Channel 2 maximum range | Depends on the connected probe and the measure type |
| 3220 | F32 | Channel 3 minimum range | Depends on the connected probe and the measure type |
| 3230 | F32 | Channel 3 maximum range | Depends on the connected probe and the measure type |

13.5.4 Alarms paramaters

| Modbus | Register type | Description | Possibilities |
|----------------|---------------|------------------|---|
| Alarm 1 | | | |
| 4000 | U8 | Alarm mode | 0: none, 1: down threshold, 2: up threshold, 3: both thresholds |
| 4010 | F32 | Hysteresis | Positive value that must belong to the range defined by up and down thresholds |
| 4020 | F32 | Threshold Up | Up threshold for alarm raising condition |
| 4030 | F32 | Threshold Down | Down threshold for alarm raising condition |
| 4040 | U32 | Delay Time | Time to wait before activating alarm when conditions are reached. This value must be between 0 and 600 |
| 4050 | U32 | Delay End | Time to wait before deactivating alarm when conditions are no more reached. This value must be between 0 and 600 |
| 4060 | BOOLEAN | Enabled/Disabled | 0: disabled, 1: enabled (always disabled if alarm mode is 0) |

| | | | |
|----------------|---------|--------------------------|---|
| 4080 | BOOLEAN | Audible alarm | 0: no sound, 1: Sound in case of alarm |
| 4090 | U8 | Acknowledgement duration | Allowed delay to acknowledge the alarm. This value must belong to range [0, 60] |
| Alarm 2 | | | |
| 4100 | U8 | Alarm mode | 0: none, 1: down threshold, 2: up threshold, 3: both thresholds |
| 4110 | F32 | Hysteresis | Positive value that must belong to the range defined by up and down thresholds |
| 4120 | F32 | Threshold Up | Up threshold for alarm raising condition |
| 4130 | F32 | Threshold Down | Down threshold for alarm raising condition |
| 4140 | U32 | Delay Time | Time to wait before activating alarm when conditions are reached. This value must be between 0 and 600 |
| 4150 | U32 | Delay End | Time to wait before deactivating alarm when conditions are no more reached. This value must be between 0 and 600 |
| 4160 | BOOLEAN | Enabled/Disabled | 0: disabled, 1: enabled (always disabled if alarm mode is 0) |
| 4180 | BOOLEAN | Audible alarm | 0: no sound, 1: Sound in case of alarm |
| 4190 | U8 | Acknowledgement duration | Allowed delay to acknowledge the alarm. This value must belong to range [0, 60] |
| Alarm 3 | | | |
| 4200 | U8 | Alarm mode | 0: none, 1: down threshold, 2: up threshold, 3: both thresholds |
| 4210 | F32 | Hysteresis | Positive value that must belong to the range defined by up and down thresholds |
| 4220 | F32 | Threshold Up | Up threshold for alarm raising condition |
| 4230 | F32 | Threshold Down | Down threshold for alarm raising condition |
| 4240 | U32 | Delay Time | Time to wait before activating alarm when conditions are reached. This value must be between 0 and 600 |
| 4250 | U32 | Delay End | Time to wait before deactivating alarm when conditions are no more reached. This value must be between 0 and 600 |
| 4260 | BOOLEAN | Enabled/Disabled | 0: disabled, 1: enabled (always disabled if alarm mode is 0) |

| | | | |
|------|---------|--------------------------|--|
| 4280 | BOOLEAN | Audible alarm | 0: no sound, 1: Sound in case of alarm |
| 4290 | U8 | Acknowledgement duration | Allowed delay to acknowledge the alarm. This value must belong to range [0, 60] |

13.5.5 Probes and module parameters

| Modbus | Register type | Description | Possibilities |
|----------------------|---------------|---|--|
| Probe Entry 1 | | | |
| 6000 | F32 | Lower limit of probe range, for each available measure | For maximum 10 measures (@6000: lower range of measure 1, @6002: lower range of measure 2, etc...). |
| 6020 | F32 | Upper limit of probe range, for each available measure | For maximum 10 measures (@6000: upper range of measure 1, @6002: upper range of measure 2, etc...). |
| 6040 | U8 | Atmospheric pressure compensation unit | cf. units enumeration |
| 6050 | F32 | Atmospheric pressure compensation value. In case of pressure, this value is used for velocity calculation | In Pa. |
| 6060 | U8 | Type of pressure equipment plugged in order to determine the air velocity | 0: Pitot tube S, 1: Pitot tube L, 2: debimo blades, 3: other (set pressure Equipment Coeff instead), 4: None |
| 6070 | F32 | Custom coefficient for pressure device plugged in order to determine the air velocity | From 0.0001 to 9.9999. |
| 6080 | U8 | Room volume unit | cf. units enumeration |
| 6090 | F32 | Room volume value in cubic meter used for computing air renewing rate (ACR) | In cubic meter. |
| 6100 | U8 | Measurement integration | From 0 to 9. |
| 6110 | U8 | Temperature compensation mode | 0: Use internal sensor, 1: Manual – refer to user value, 2: Use probe id 0 (or user if not present), 3: Use probe id 1 (or user if not present), 4: Use probe id 2 (or user if not present). |
| 6120 | U8 | Manual temperature compensation unit | cf. units enumeration |
| 6130 | F32 | Manual temperature compensation value in Celsius degrees | From -50 to 50, in Celsius degrees. |
| 6140 | F32 | Correction factor used for air velocity and airflow probes | From 0.2 to 2 - Used for air velocity and airflow probes (default = 1). |
| 6150 | U8 | Type of section used for air velocity and airflow probes | 0: rectangular, 1: circular, 2: other (set airflow coefficient instead), 3: None (not configured) |
| 6160 | U8 | Unit for section diameter, section length and section width | cf. units enumeration |
| 6170 | F32 | Section diameter value in meters (used when section type is circular) | From 0.001 to 3. |

| | | | |
|----------------------|-----|---|--|
| 6180 | F32 | Section length value in meters (used when section type is rectangular) | From 0.001 to 3. |
| 6190 | F32 | Section width value in meters (used when section type is rectangular) | From 0.001 to 3. |
| 6200 | F32 | Airflow coefficient (allows to calculate an airflow from the pressure) | From 0.1 to 9999.9. |
| Probe Entry 2 | | | |
| 6300 | F32 | Lower limit of probe range, for each available measure | For maximum 10 measures (@6300: lower range of measure1, @6302: lower range of measure2, etc...). |
| 6320 | F32 | Upper limit of probe range, for each available measure | For maximum 10 measures (@6300: upper range of measure 1, @6302: upper range of measure 2, etc...). |
| 6340 | U8 | Atmospheric pressure compensation unit | cf. units enumeration |
| 6350 | F32 | Atmospheric pressure compensation value. In case of pressure, this value is used for velocity calculation | In Pa. |
| 6360 | U8 | Type of pressure equipment plugged in order to determine the air velocity | 0: Pitot tube S, 1: Pitot tube L, 2: Debimo blades, 3: other (set pressureEquipmentCoeff instead), 4: None |
| 6370 | F32 | Custom coefficient for pressure device plugged in order to determine the air velocity | From 0.0001 to 9.9999. |
| 6380 | U8 | Room volume unit | cf. units enumeration |
| 6390 | F32 | Room volume value in cubic meter used for computing air renewing rate (ACR) | In cubic meter. |
| 6400 | U8 | Measurement integration | From 0 to 9. |
| 6410 | U8 | Temperature compensation mode | 0: Use internal sensor, 1: Manual – refer to user value, 2: Use probe id 0 (or user if not present), 3: Use probe id 1 (or user if not present), 4: Use probe id 2 (or user if not present). |
| 6420 | U8 | Manual temperature compensation unit | cf. units enumeration |
| 6430 | F32 | Manual temperature compensation value in Celsius degrees | From -50 to 50, in Celsius degrees. |
| 6440 | F32 | Correction factor used for air velocity and airflow probes | From 0.2 to 2] - Used for air velocity and airflow probes (default = 1). |
| 6450 | U8 | Type of section used for air velocity and airflow probes | 0: rectangular, 1: circular, 2: other (set airflow coefficient instead), 3: None (not configured) |
| 6460 | U8 | Unit for section diameter, section length and section width | cf. units enumeration |

| | | | |
|---------------|-----|---|---|
| 6470 | F32 | Section diameter value in meters (used when section type is circular) | from 0.001 to 3 |
| 6480 | F32 | Section length value in meters (used when section type is rectangular) | from 0.001 to 3 |
| 6490 | F32 | Section width value in meters (used when section type is rectangular) | from 0.001 to 3 |
| 6500 | F32 | Airflow coefficient (allows to calculate an airflow from the pressure) | from 0.1 to 9999.9 |
| Module | | | |
| 6600 | F32 | Lower limit of probe range, for each available measure | for maximum 10 measures (@6600: lower range of measure 1, @6602: lower range of measure 2, etc...) |
| 6620 | F32 | Upper limit of probe range, for each available measure | for maximum 10 measures (@6600: upper range of measure 1, @6602: upper range of measure 2, etc...) |
| 6640 | U8 | Atmospheric pressure compensation unit | cf. units enumeration |
| 6650 | F32 | Atmospheric pressure compensation value. In case of pressure, this value is used for velocity calculation | in Pa |
| 6660 | U8 | Type of pressure equipment plugged in order to determine the air velocity | 0: Pitot tube S, 1: Pitot tube L, 2: Debimo blades, 3: other (set pressureEquipmentCoeff instead), 4: None |
| 6670 | F32 | Custom coefficient for pressure device plugged in order to determine the air velocity | from 0.0001 to 9.9999 |
| 6680 | U8 | Room volume unit | cf. units enumeration |
| 6690 | F32 | Room volume value in cubic meter used for computing air renewing rate (ACR) | in cubic meter |
| 6700 | U8 | Measurement integration | from 0 to 9 |
| 6710 | U8 | Temperature compensation mode | 0: Use internal sensor, 1: Manual – refer to user value, 2: Use probe id 0 (or user if not present), 3: Use probe id 1 (or user if not present), 4: Use probe id 2 (or user if not present) |
| 6720 | U8 | Manual temperature compensation unit | cf. units enumeration |
| 6730 | F32 | Manual temperature compensation value in Celsius degrees | From -50 to 50, in Celsius degrees. |
| 6740 | F32 | Correction factor used for air velocity and airflow probes | From 0.2 to 2 - Used for air velocity and airflow probes (default = 1). |
| 6750 | U8 | Type of section used for air velocity and airflow probes | 0: rectangular, 1: circular, 2: other (set airflow coefficient instead), 3: None (not configured). |
| 6760 | U8 | Unit for section diameter, section length and section width | cf. units enumeration |

| | | | |
|------|-----|--|---------------------|
| 6770 | F32 | Section diameter value in meters (used when section type is circular) | From 0.001 to 3. |
| 6780 | F32 | Section length value in meters (used when section type is rectangular) | From 0.001 to 3. |
| 6790 | F32 | Section width value in meters (used when section type is rectangular) | From 0.001 to 3. |
| 6800 | F32 | Airflow coefficient (allows to calculate an airflow from the pressure) | From 0.1 to 9999.9. |

13.5.6 Normative values

| Modbus | Register type | Description | Possibilities |
|--------|---------------|-----------------|---------------|
| 6900 | U8 | Normative Value | |

13.5.7 Measurement alarms

| Modbus | Register type | Description | Possibilities |
|--------|---------------|--------------------------|---|
| 7000 | BOOLEAN | Alarm 1 raised | 0: Inactive, 1: Active |
| 7010 | F32 | Channel 1 measured value | In unit selected for the channel (cf register 2000). |
| 7020 | U8 | Channel 1 measure status | 0: OK, 1: Out of range, 2: Error, 3: Heating |
| 7030 | I8 | Channel 1 trend | 0: down, 1: equal, 2: up, 3: not available |
| 7040 | U8 | Channel 1 error reason | 0: none, 1: internal, 2: not configured, 3: measure, 4: unplugged probe, 5: invalid probe, 6: probe to update |
| 7100 | BOOLEAN | Alarm 2 raised | 0: Inactive, 1: Active |
| 7110 | F32 | Channel 2 measured value | In unit selected for the channel (cf register 2100). |
| 7120 | U8 | Channel 2 measure status | 0: OK, 1: Out of range, 2: Error, 3: Heating |
| 7130 | I8 | Channel 2 trend | 0: down, 1: equal, 2: up, 3: not available |
| 7140 | U8 | Channel 2 error reason | 0: none, 1: internal, 2: not configured, 3: measure, 4: unplugged probe, 5: invalid probe, 6: probe to update |
| 7200 | BOOLEAN | Alarm 3 raised | 0: Inactive, 1: Active |
| 7210 | F32 | Channel 3 measured value | In unit selected for the channel (cf register 2200). |
| 7220 | U8 | Channel 3 measure status | 0: OK, 1: Out of range, 2: Error, 3: Heating |
| 7230 | I8 | Channel 3 trend | 0: down, 1: equal, 2: up, 3: not available |
| 7240 | U8 | Channel 3 error reason | 0: none, 1: internal, 2: not configured, 3: measure, 4: unplugged probe, 5: invalid probe, 6: probe to update |

Sauermann Industrie
ZA Bernard Moulinet
24700 Montpon-Ménéstérol
France
T. +33 (0)5 53 80 85 00
services@sauermanngroup.com

Sauermann NA
10 W. College Avenue, Unit B
Yardley, Pennsylvania 19067
T. (+1) 215-750-1212

Sauermann GmbH
Leibnizstraße 6
D – 74211 Leingarten
T. +49 (0)7131/399990
F. +49 (0)7131/399992

Sauermann UK
Units 7-9, Trident Business Park
Amy Johnson Way
Blackpool - FY4 2RP
T. +44 (0) 870 950 6378
F. +44 (0) 870 950 6379

Sauermann Italia srl S.U
Via G. Golini 61/10
40024 Castel S.Pietro Terme (BO)
T. (+39)-051-6951033
F. (+39)-051-942254

Sauermann Ibérica
C/Albert Einstein 33.
Planta 3. P. I. Santa Margarida II-
08223 Terrassa (Spain)
T. +34 931 016 975

Sauermann Australia
Unit 1/36 Campbell Ave,
Cromer, NSW, 2099
T. (+612) 8880 4631

Sauermann China
Room 209, Building 7,
No. 3000 Longdong Ave.
Pudong New District
Shanghai 201203
R.P. China
T. (+86) 21 6100 1877

 **BE CAREFUL!** Material damages can happen, so please apply the precautionary measures indicated.

Kimo, a Sauermann brand.

sauermanngroup.com