

INSTRUCTION MANUAL

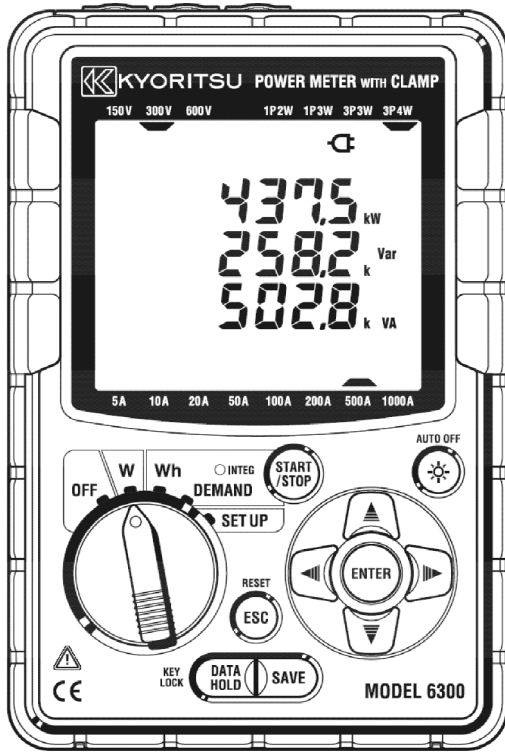

DIGITAL POWER METER

MODEL 6300



KYORITSU ELECTRICAL INSTRUMENTS WORKS, LTD.,
TOKYO, JAPAN

Contents	1
Unpacking	4
Safety warnings	6
Section 1 Instrument overview	1.1
1-1 Features	1.1
1-2 Functional overview	1.3
1-3 Measurement procedures	1.4
1-4 Outline of demand measurement	1.5
Section 2 Instrument layout	2.1
2-1 Display & keys	2.1
2-2 Connector	2.5
2-3 CF card/ USB part	2.6
Section 3 Preparation for measurement	3.1
3-1 Power cord connection	3.1
3-2 Voltage test leads and Clamp sensor connection	3.2
3-3 Turning on the instrument	3.4
3-3-1 Start-up screen	3.4
3-3-2 Error message	3.5
3-3-3 Operating with batteries	3.6
Section 4 Setting	4.1
4-1 List of setting items	4.2
4-2 Classification of setting items	4.3
4-3 Setting procedure of each setting item	4.4
4-3-1 "Setting 01" Wiring	4.5
4-3-2 "Setting 02" Voltage range	4.6
4-3-3 "Setting 03" Current range	4.7
4-3-4 "Setting 04" Clamp sensor	4.8
4-3-5 "Setting 05" VT ratio	4.9
4-3-6 "Setting 06" CT ratio	4.10
4-3-7 "Setting 07" Time	4.11
4-3-8 "Setting 08" Buzzer	4.12
4-3-9 "Setting 09" Integration interval	4.13
4-3-10 "Setting 10" Integration start date and time	4.14
4-3-11 "Setting 11" Integration stop date and time	4.15
4-3-12 "Setting 12" Reset of integration value	4.16
4-3-13 "Setting 13" Demand Interval	4.17
4-3-14 "Setting 14" Demand start date and time	4.18
4-3-15 "Setting 15" Demand stop date and time	4.19
4-3-16 "Setting 16" Demand target value	4.20
4-3-17 "Setting 17" Demand inspection cycle	4.21
4-3-18 "Setting 18" Reset of demand value	4.22
4-3-19 "Setting 19" Use of CF card	4.23

	4-3-20	"Setting 20" Formatting CF card	4.24
	4-3-21	"Setting 21" Deleting the data in CF card	4.26
	4-3-22	"Setting 22" Deleting the data in Internal memory	4.27
	4-3-23	"Setting 23" System reset	4.28
	4-3-24	"Setting 24" Loading settings	4.29
	4-3-25	"Setting 25" Saving settings	4.30
Section 5	Wiring		5.1
	5-1	Check prior to do wiring	5.1
	5-2	Basic wiring metohd	5.2
	5-3	VT/CT	5.4
Section 6	Instantaneous value measurement		6.1
	6-1	Wiring display screen	6.4
	6-2	Switching the display screen	6.6
	6-3	Customizing the display	6.9
	6-4	Saving data	6.12
	6-4-1	How to save	6.12
	6-4-2	Limitation of saving	6.14
	6-4-3	Save data	6.15
	6-5	Digit / Over-range indication	6.17
	6-5-1	Digits	6.17
	6-5-2	Over-range indication / Bar indication	6.19
Section 7	Integration value measurement		7.1
	7-1	How to start measurement	7.4
	7-2	How to stop measurement	7.7
	7-3	Resetting the integration value	7.9
	7-4	Switching displays	7.10
	7-5	Saving data	7.12
	7-5-1	How to save	7.12
	7-5-2	Limitation of saving	7.13
	7-5-3	Save data	7.15
	7-6	Digits / Over-range indication	7.17
Section 8	Demand value measurement		8.1
	8-1	Demand measurement	8.4
	8-2	Displayed items and how to switch	8.7
	8-3	How to start measurement	8.9
	8-4	How to stop measurement	8.12
	8-5	Resetting the demand value	8.14
	8-6	Saving data	8.15
	8-6-1	How to save	8.15
	8-6-2	Limitation of saving	8.16
	8-6-3	Save data	8.18
	8-7	Digits / Over-range indication	8.20

Section 9	CF card/ Internal memory	9.1
9-1	Instrument and CF card/ Internal memory	9.1
9-2	Placing / removing the CF card	9.3
9-3	Formatting or saving data in CF card/ Internal memory	9.4
Section 10	Communication function/ Supplied software	10.1
10-1	Install (KEW POWER PLUS)	10.2
10-2	Install (USB driver)	10.4
10-3	Start "KEW POWER PLUS"	10.6
10-4	Connecting the instrument and PC	10.7
10-5	Download to PC	10.8
10-6	Set up via PC	10.10
10-7	Uninstall (USB driver)	10.12
Section 11	Other functions	11.1
Section 12	When defect or breakdown is suspected	12.1
12-1	Trouble-shooting	12.1
12-2	Battery replacement	12.3
Section 13	Specification	13.1
13-1	General specification	13.1
13-2	Instantaneous value measurement	13.3
13-3	Integration value measurement	13.5
13-4	Demand value measurement	13.6
13-5	Other specifications	13.7
13-6	Specification of Clamp sensor	13.8

Unpacking

Thank you very much for buying our digital Power Meter "MODEL6300".
Please unpack the package and check the instrument before use.

● Items below are in the package

1	Main unit	MODEL6300 :1 unit
2	Voltage test lead	MODEL7141: 1 set (red, black, green, blue: 1pce for each)
3	Power cord	MODEL7170: 1pce
4	USB cord	MODEL7148: 1pce
5	Quick manual	1pce
6	CD-ROM	1pce
7	Battery	Alkaline size AA battery LR6: 6pcs
8	Carrying case	MODEL9125: 1pce

Optional parts

9	Clamp sensor	As many as you purchased
10	Instruction manual for clamp sensor	1pce for each clamp sensor
11	Compact flash card	32MB

1. Main unit

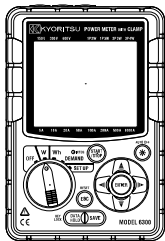

2. Voltage test leads

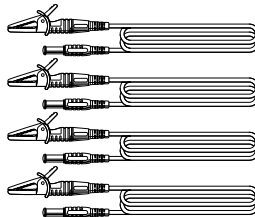

3. Power cord



4. USB cord

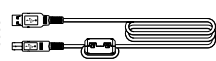

8. Carrying case

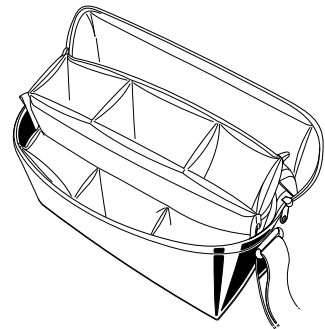

5. Quick manual

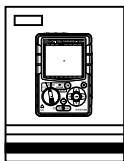

6. CD-ROM



7. Batteries



9. Clamp sensor
(as many as you purchased)

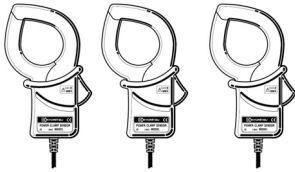

10. Instruction manual for clamp sensor

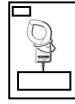

11. Compact flash card



• **How to store the items**

Please store the items as shown below after use.

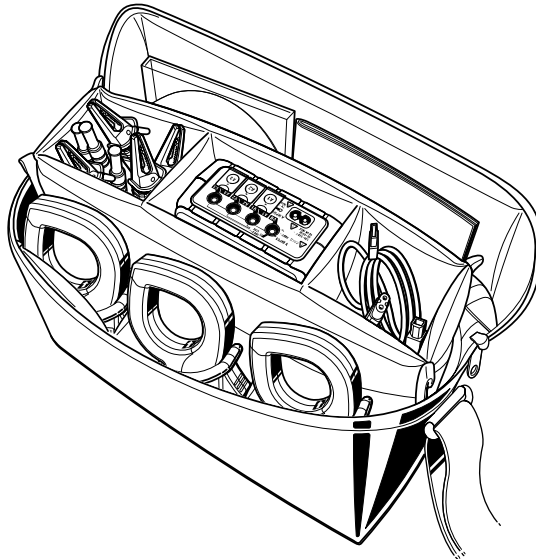

- In case that wrong items are packed, an item is missing or damaged, or printing is garbled, please contact the distributor from who you purchased this instrument.

Safety warnings



This instrument has been designed, manufactured and tested according to IEC 61010: Safety requirements for Electronic Measuring apparatus, and delivered in the best condition after passed the inspection.



This instruction manual contains warnings and safety rules which must be observed by the user to ensure safe operation of the instrument and retain it in safe condition. Therefore, read through these operating instructions before using the instrument.

WARNING

- Read through and understand the instructions contained in this manual before starting to use the instrument.
- Save and keep the manual at hand to enable quick reference whenever necessary.
- Be sure to use the instrument only in its intended applications.
- Be sure to understand and follow all safety instructions contained in the manual.
- Read the enclosed Quick manual after reading this instruction manual.
- As to the manipulation of Clamp sensor, please also refer to the instruction manual supplied with the sensor.

Be sure to observe the above instructions. Failure to follow the above instructions may cause injury, instrument damage and/or damage to equipment under test.

The symbol  indicated on the instrument means that the user must refer to the related parts in the manual for safe operation of the instrument. Be sure to carefully read the instructions following each  symbol in the manual.

-  **DANGER** is reserved for conditions and actions that are likely to cause serious or fatal injury.
-  **WARNING** is reserved for conditions and actions that can cause serious or fatal injury.
-  **CAUTION** is reserved for conditions and actions that can cause injury or instrument damage.

DANGER

- Never make measurement on the circuit in which electrical potential over AC600V exists.
- Do not attempt to make measurement in the presence of flammable gasses. Otherwise, the use of the instrument may cause sparking, which can lead to an explosion.
- Never attempt to use the instrument if its surface or your hand is wet.
- Do not exceed the maximum allowable input of any measuring range.
- Never open the Battery cover and CF card connector cover during a measurement.
- Verify proper operation on a known source before use or taking action as a result of the indication of the device.

⚠ WARNING





- Never attempt to make measurement if any abnormal conditions, such as broken case and exposed metal parts are found on the instrument, Voltage test leads, Power cord and Clamp sensor.
- Be sure to close the Current input terminal cover, USB connector cover and CF card connector cover which are not in use during a measurement. Be sure to tighten up the screw for CF card connector cover.
- Do not install substitute parts or make any modification to the instrument. Return the instrument to us or the distributor for repair or re-calibration.
- Be sure to firmly insert the Power cord, Voltage test leads and Clamp sensor into the terminal.
- Do not try to replace the batteries if the surface of the instrument is wet.
- Make sure to remove the Power cord, Voltage test leads and Clamp sensor from the instrument, and then turn off the instrument when opening the Battery cover for battery replacement.

⚠ CAUTION

- Always make sure to set the Function switch to the appropriate position before making measurement.
- Be sure to set the Function switch to “OFF” position after use and remove the Power cord, Voltage test leads and Clamp sensors. When the instrument will not be in use for a long period, place it in storage after removing the batteries.
- Do not expose the instrument to the direct sun, high temperature and humidity or dewfall.
- Use a cloth dipped in water or neutral detergent for cleaning the instrument. Do not use abrasives or solvents.
- When this instrument is wet, please store it after it dries.

Be sure to carefully read and follow the instructions: **⚠ DANGER**, **⚠ WARNING**, **⚠ CAUTION** and **NOTE**, described in each section.

Following symbols are used in this manual.

	User must refer to the explanations in the instruction manual.
	Instrument with double or reinforced insulation
	AC
	(Functional) Earth terminal

1. Instrument overview

Following explains about the features and functions of this instrument.

1-1 Features

This instrument is a clamp power meter, and can be used for various wiring systems. As to single-phase 2-wire circuit, this instrument can measure up to 3 loads, that is; three in one.

This instrument can measure fundamental electric power factors, namely, instantaneous value and integration value. Moreover, demand measurement, which is important to control electricity, is available.

Each data can be saved to CF (compact flash) card or PC by USB communication.

- Safety design

Designed to international safety standard IEC61010.

- Wiring

This instrument supports:

single-phase 2-wire (1ch), single-phase 2-wire (2ch), single-phase 2-wire (3ch), single-phase 3-wire, three-phase 3-wire, three-phase 4-wire.

- Measurement and calculation

This instrument measures and calculates:

voltage(RMS), current(RMS), active/ reactive/ apparent power, power factor, frequency, current flowing on the neutral line(only at three-phase 4-wire) active/ reactive/ apparent electric energy.

- Demand measurement

With this instrument, you can control the usage of electricity easily so as not to exceed the target (contract demand) electricity.

- Saving the measured data

Instantaneous value can be saved whenever the **SAVE** key is pressed.

Integration value and demand value can be saved in wide cycle from 1 sec. to 1 hour.

In addition, max and average instantaneous values can be measured at Integration/ demand measurement cycle.

- Power supply

This instrument operates either with AC power supply or battery.

In the event of service interruption while the instrument is operating with AC power supply, power to the instrument is automatically switched to the battery set in the instrument.

Batteries can be also used for backing up the data.

- Large display

Any three measurement items can be displayed at once.

(e.g. Current, Active power, Power factor)

- Customizing display

Three measurement items can be switched to any desired items by customizing display screen.

- Backlight

Backlight function to view the test results in dimly lit areas.

- Clamp type, light & compact design

Can clamp the measured object easily.

Easy-to install, portable.

1-2 Functional overview

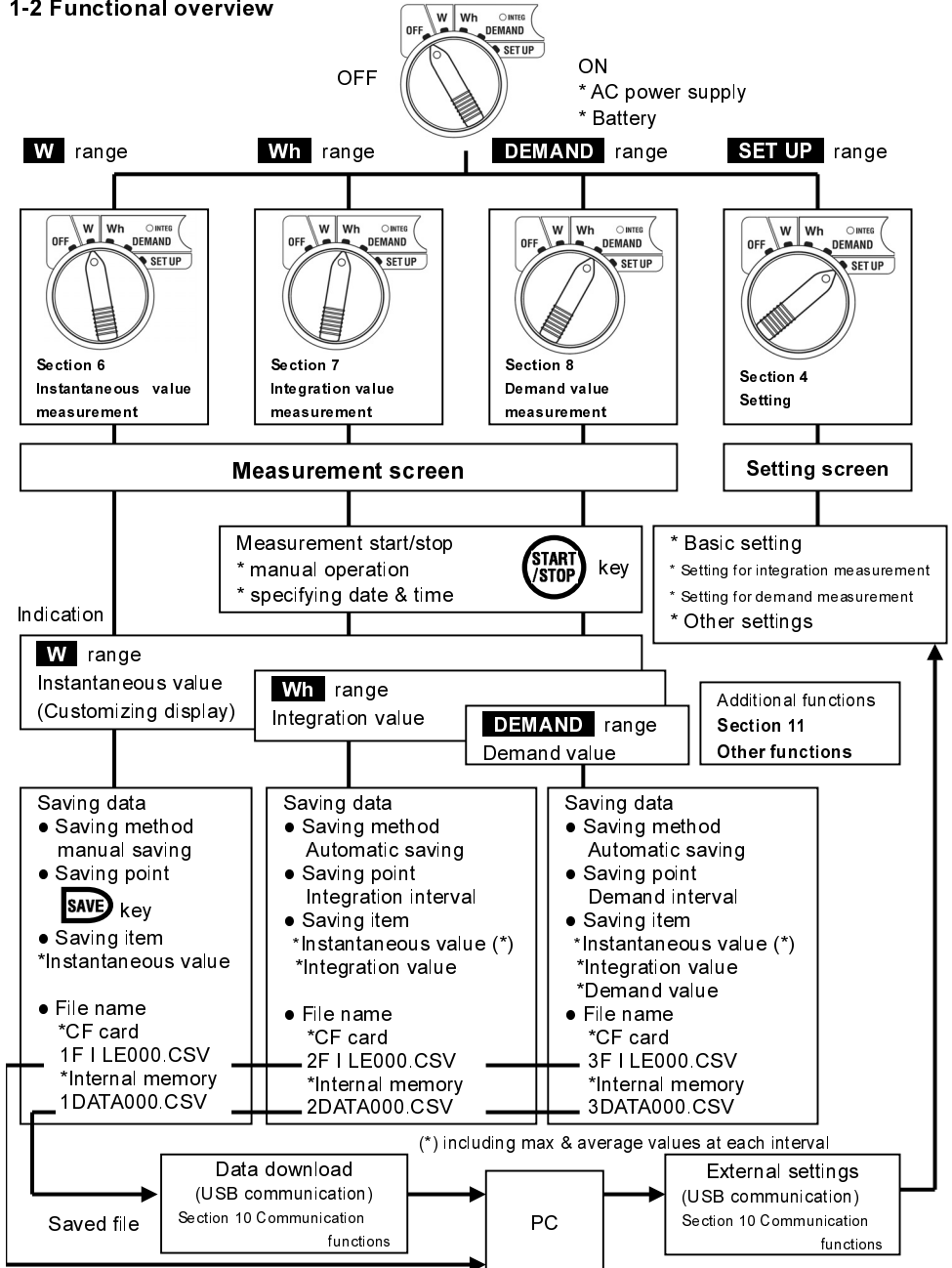

1-3 Measurement procedures

- Measurement flow chart

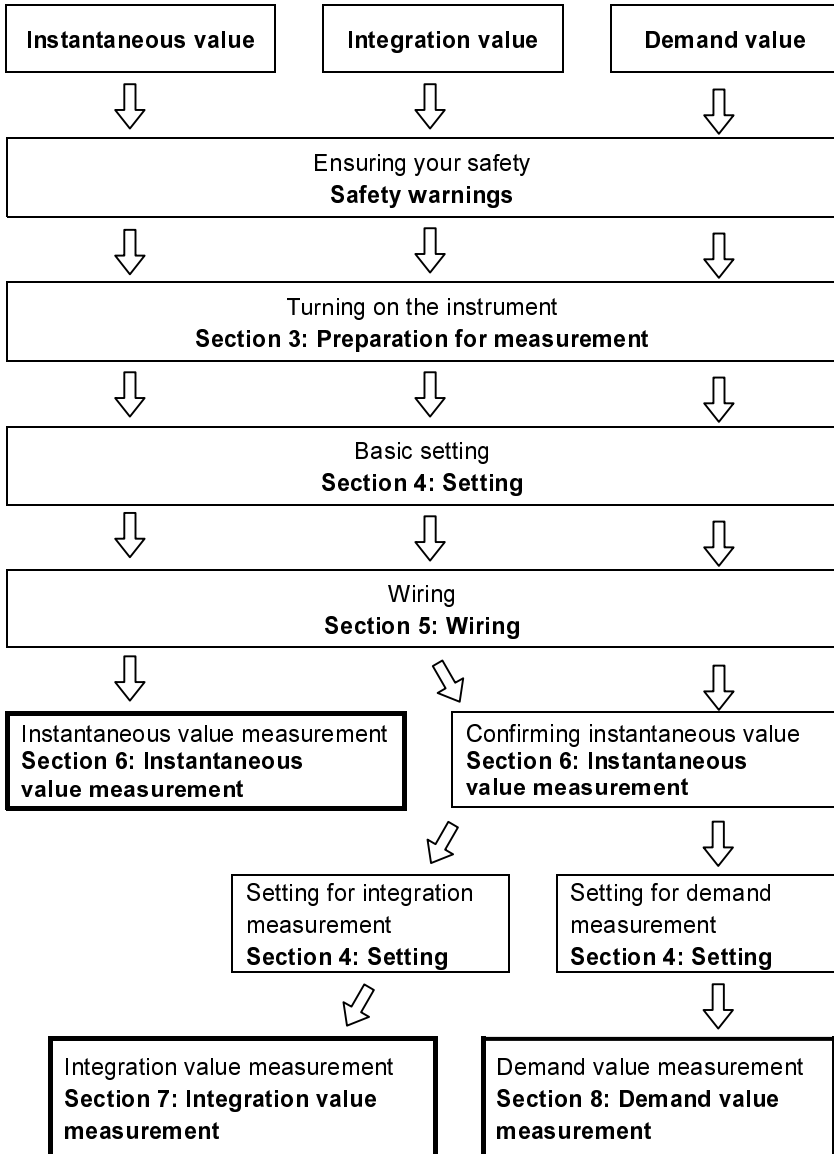

1-4 Outline of demand measurement

Depending on countries, a consumer of large electricity will make a demand contract with a power company. Following explains demand contract with taking Japanese demand contract as an example.

- Demand contract

Demand contract is to be made between electricity user and power company, and the basic charges for electricity is decided based on the max power for 30min, which is measured with the recorder (demand meter) installed by a power company.

Suppose you made the contract at 500kW/year, and the recorded demand (for 30min) was max 600kW on January 15. (100kW exceeded against 500kW)

Then, how much you try to save electricity, the basic charge will be calculated based on 600kW for one year from February. One year later, when the recorded demand as of February is 300kW, the contract demand will be changed to 300kW. But if 600kW is used in March, the contract demand will be changed to 600kW for another year. In order to avoid such demand charges, large factories are controlling demands.

- Status of demand contract

In past days, only the customers who use electricity of 600kW or more used to make a demand contract. But now power companies install demand meters for all the electric customers who have a high voltage access-to-electricity of 70kW or more.

(For the equipment of 70kW or less, demand contract is to be made based on the distribution board for it.)

- Effect of demand control

Like mentioned in above passage, if the demand can be reduced from 600kW to 300kW, you can save:

$$(600 \text{ kW} - 300 \text{ kW}) \times (\text{price per kW}) \times \text{power factor}$$

Demand control works effectively in the country with high electricity charges.

- Demand measurement function

With this instrument, you can easily control the usage of electricity so as not to exceed the target value (contract demand). However, a demand meter, which is installed by a power company, and this instrument may not match completely due to time-lag.

Recording the max electricity within the specified period with this instrument makes sense to control the electricity.

2. Instrument layout

2-1 Display & keys

- Front view

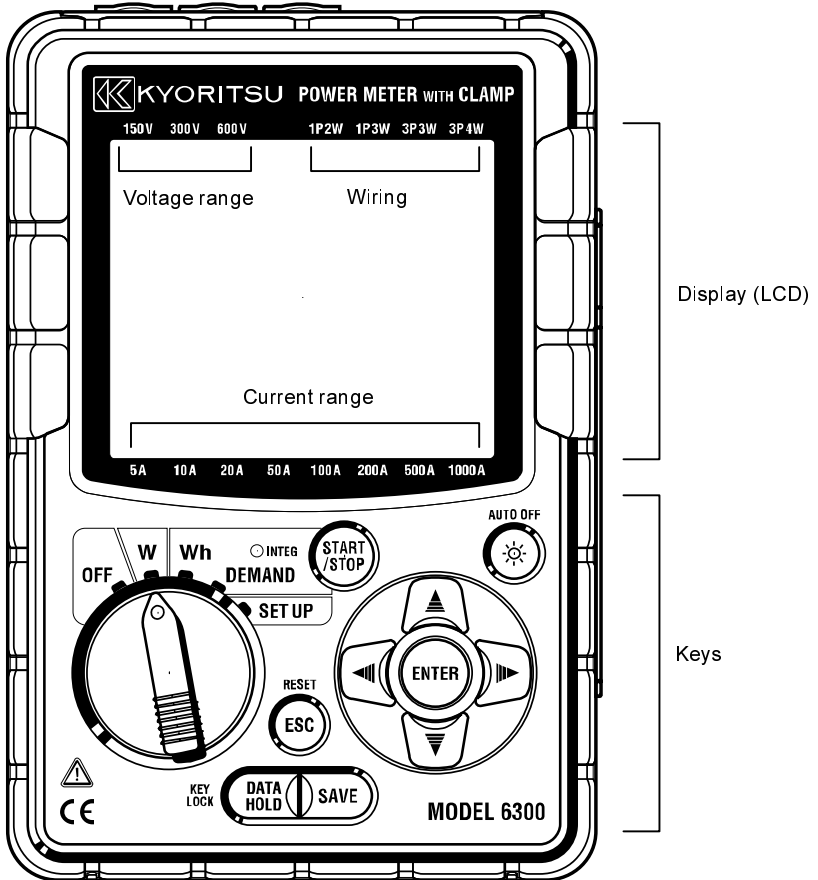

• Key operations

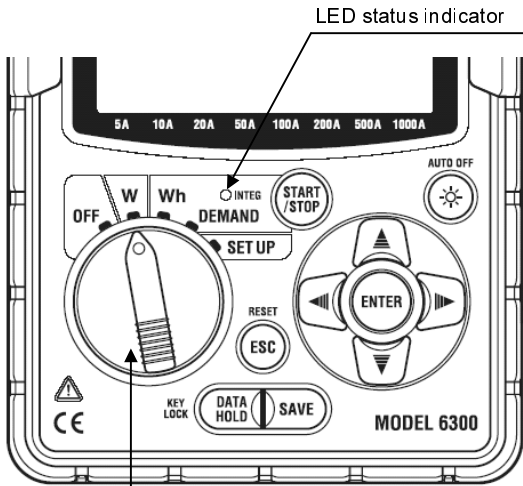

Lights up:
During integration/
demand measurement
Blinks:
During integration/
demand stand-by mode

Function switch: turns on the instrument when it is at any position other than OFF.

Keys		Details
	START/STOP key	Starts/ Stops integration or demand measurement.
	BACKLIGHT key	Switches on/off the backlight of the LCD.
	Cursor key	Measurement screen: Switches the display contents. Setting screen: Changes selection, number, or moves digits.
	ENTER key	Confirms entry such as a change to a setting.
	ESC key	* Cancels a setting * Clears integration/ demand value
	DATA HOLD key	* Data hold * Key lock Pressing this key for 2sec or more locks keys. Pressing this key for 2sec or more again releases key lock.
	SAVE key	Saves the instantaneous measurement data.



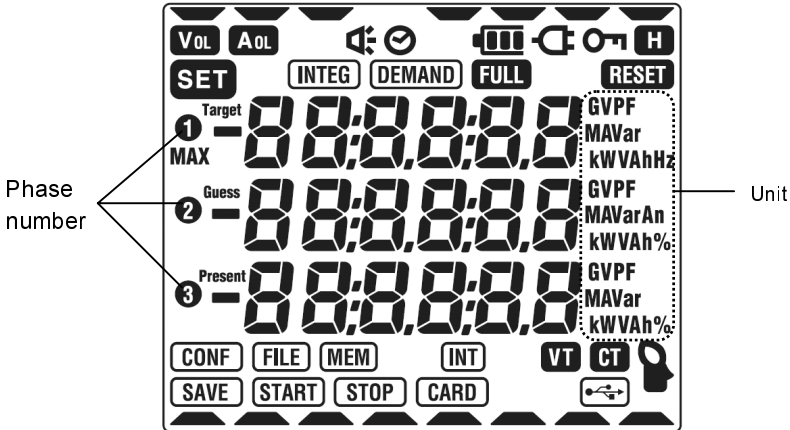

- Marks displayed on the LCD
- < All marks to be displayed on the LCD >



< Marks indicate the measurement status or functions >

	Lights up when the keys are locked.
	Lights up when voltage exceeds a certain value.
	Lights up when current exceeds a certain value.
	Lights up when instrument is operating with AC power supply.
	Lights up when instrument is operating with batteries.
	Lights up when data hold function is activated.
	Lights up during integration, Blinks during stand-by mode.
	Lights up during demand, Blinks during stand-by mode.
	Lights up when the capacity of CF card or internal memory is exceeded.
	Lights up while saving data to CF card.
	Lights up when opening/ closing a file during measurement.
	Lights up when saving data.
	Lights up when a file exists in the internal memory.
	Lights up when VT ratio is set to at a value other than 1.
	Lights up when CT ratio is set to at a value other than 1.



<Setting screen: Marks displayed on **SET UP** range depending on each setting.>

SET	Light up on every setting screen.
	“Setting 04” Clamp sensor
VT	“Setting 05” VT ratio
CT	“Setting 06” CT ratio
	“Setting 07” Time
	“Setting 08” Buzzer
INTEG INT	“Setting 09” Integration interval
INTEG START	“Setting 10” Integration start date & time
INTEG STOP	“Setting 11” Integration stop date & time
INTEG RESET	“Setting 12” Reset of Integration value
DEMAND INT	“Setting 13” Demand interval
DEMAND START	“Setting 14” Demand start date & time
DEMAND STOP	“Setting 15” Demand stop date & time
DEMAND Target	“Setting 16” Demand target value
DEMAND 	“Setting 17” Demand inspection cycle
DEMAND RESET	“Setting 18” Reset of Demand value
CARD	“Setting 19” Use of CF card “Setting 20” Formatting CF card “Setting 21” Deleting the data in CF card
MEM	“Setting 22” Deleting the data in internal memory
RESET	“Setting 23” System reset
CONF	“Setting 24” Loading settings “Setting 25” Saving settings

< Marks indicate measurement/ setting items on **DEMAND** range.>

Target	Demand target value
Guess	Demand predicted value
Present	Present demand value
MAX	Max demand value, and the date and time when it was recorded.

< Other marks>

	Indicates the selected wiring, voltage range and current range
	Lights up during data communication via USB.

2-2 Connector

- Descriptions

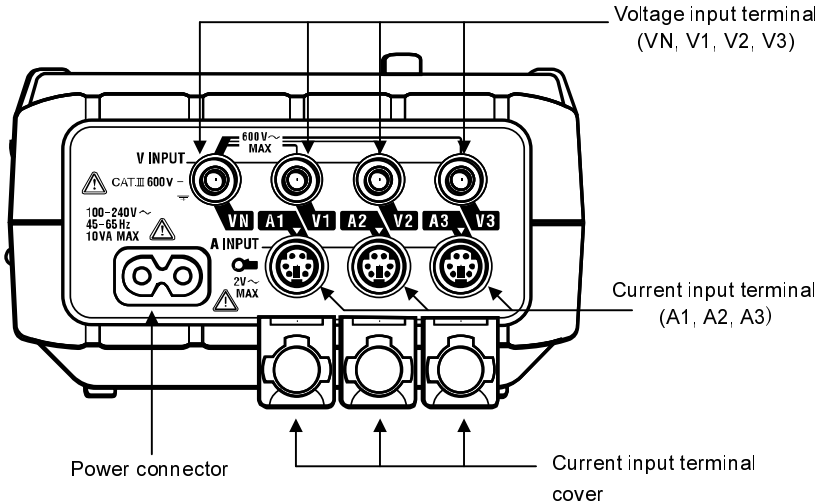

- Terminals used for measuring each wiring

Wiring	Voltage input terminal	Current input terminal
Single-phase 2-wire (1ch) "1P2W(1ch)"	VN-V1	A1
Single-phase 2-wire (2ch) "1P2W(2ch)"	VN-V1	A1, A2
Single-phase 2-wire (3ch) "1P2W(3ch)"	VN-V1	A1, A2, A3
Single-phase 3-wire "1P3W"	VN-V1, VN-V2	A1, A2
Three-phase 3-wire "3P3W"	VN-V1, VN-V2	A1, A2
Three-phase 4-wire "3P4W"	VN-V1, VN-V2, VN-V3	A1, A2, A3

2-3 CF card/ USB part

- Descriptions

<When the cover is closed>

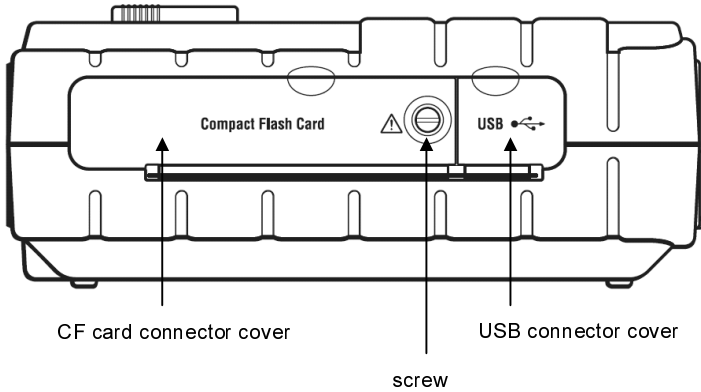

<When the cover is opened>

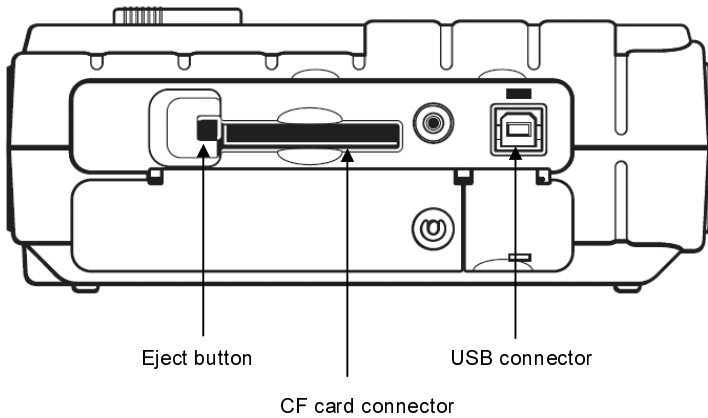

3. Preparation for measurement

Following explains how to connect Power cord, Voltage test leads and Clamp sensor, and also explains how to turn on the instrument.

3-1 Power cord connection

- Be sure to check followings before connecting the Power cord.

DANGER

- Be sure to use the Power cord supplied with this instrument.
- Make sure to connect the Power cord to an outlet. Do not connect the cord with device in which AC240V or higher may exist.

WARNING

- Confirm that the Function switch on the instrument is at OFF position, and then connect the Power cord.
- Be sure to connect the Power cord to the instrument first. Cord shall be firmly inserted.
- Never attempt to make measurement if any abnormal conditions are noted, such as broken case and exposed metal parts.
- When the instrument will not be in use, be sure to remove the Power cord from the outlet.
- Be sure to hold the plug part when removing the plug-in cord from the outlet.

- Power cord connection

Follow the procedure below, and connect the Power cord.

- (1) Confirm that the Function switch on the instrument is at OFF position.
- (2) Connect the supplied Power cord to the Power connector on the instrument.
- (3) Connect the other end of the Power cord to an outlet.

- Power supply rating

Rated supply voltage: 100 ~ 240VAC
($\pm 10\%$)

Rated power supply frequency: 45 ~ 65Hz

Max power consumption: 10VA max

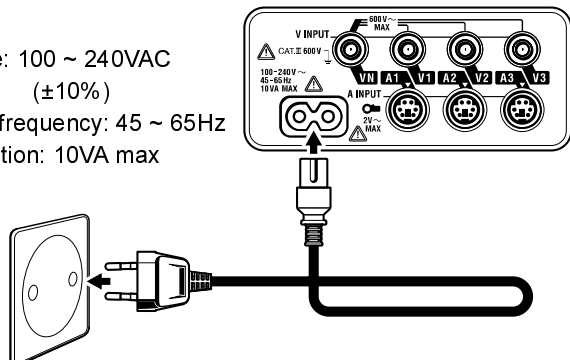

3-2 Voltage test leads and Clamp sensor connection

- Be sure to check followings before connection.



DANGER

- Be sure to use the Voltage test leads supplied with this instrument.
- Make sure to use the dedicated sensor for this instrument, and confirm that the measured current and rating are met.
- Do not connect any Voltage test leads and Clamp sensors which are not used at measurement.
- Be sure to connect the test leads and sensors to the instrument first, and then connect them to the line under test.
- Never remove the test leads and sensors from the connector on the instrument during a measurement (during test leads and sensors are energized).



WARNING

- Confirm that the Function switch on the instrument is at OFF position, and then connect the test leads and sensors.
- Be sure to connect the test leads and sensors to the instrument first. Each of them shall be firmly inserted.
- Never attempt to make any measurement if any abnormal conditions are noted, such as broken case and exposed metal parts.

- Voltage test leads and clamp sensor connection
Follow the procedure below, and connect the Voltage test leads and Clamp sensors.
 - (1) Confirm that the Function switch on the instrument is at OFF position.
 - (2) Connect the appropriate Voltage test leads to the Voltage input terminal on the instrument.
 - (3) Connect the appropriate Clamp sensors to the Current input terminal on the instrument.* Please match the direction of arrow marks indicated on the output terminal of Clamp sensor and the mark on the Current input terminal on the instrument.

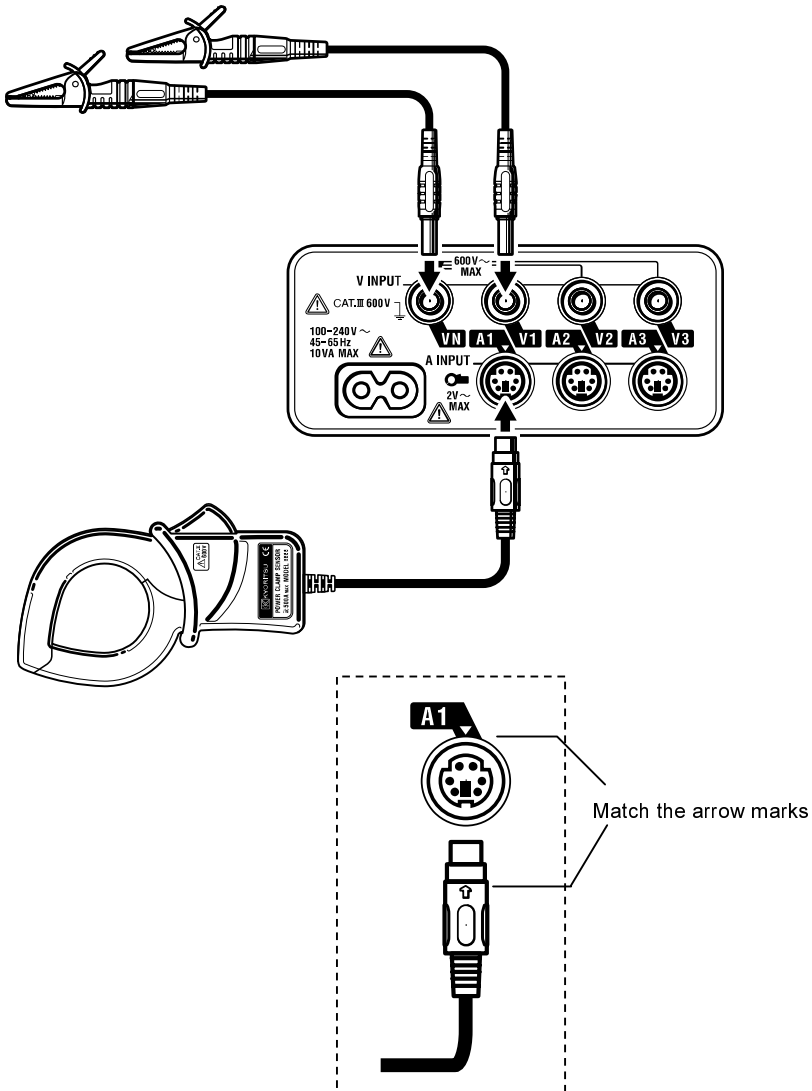
**NOTE**

- * The number of Voltage test leads and Clamp sensor to be used and the connection varies depending on each wiring. For further details, please refer to “**Section 5: Wiring**” in this manual.

3-3 Turing on the instrument

3-3-1 Start-up screen

Setting the Function switch to any range other than OFF turns on the instrument. Then following screen appears.

1. All segments on

All segments are displayed for about 1sec., then the screen switches to the MODEL/VERSION screen and being displayed for about .2sec..

All segments are on
(displayed for about 1sec.)

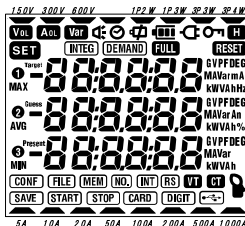

MODEL/VERSION screen
(displayed for about 2sec.)

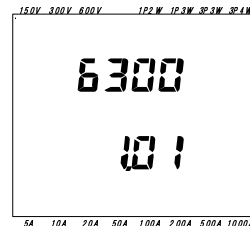

2. Display on each range

Following screen appears according to the position of Function switch.

W range

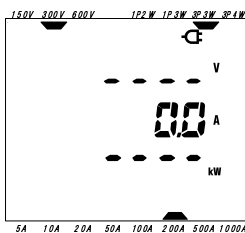

Wh range

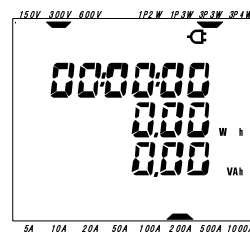

DEMAND range

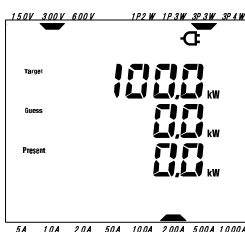

SET UP range

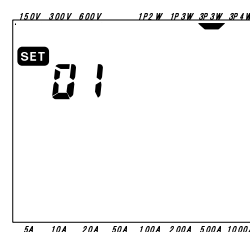

3-3-2 Error message

This instrument automatically checks the internal circuit immediately after it is turned on.

When a failure in the internal circuit is suspected, the error screen below will be displayed for about 2sec. before all segments are displayed on the LCD at turning on the instrument. In case that following screen appears, stop using the instrument immediately and refer to “**Section12: When defect or breakdown is suspected**” in this manual.

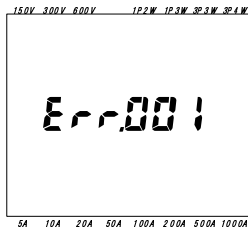

Error code (0 ~ 63)

Err.001
)
 Err.063

CAUTION



Measurement screen appears and measurement can be made even if the error screen appears. However, the accuracy of the measured value may out of specification.

3-3-3 Operating with batteries

This instrument operates either with AC power supply or batteries (typically about 7 hours continuous measurement). When AC power supply is stopped by service interruption or something, the instrument operates with batteries.

⚠ WARNING
 Never touch the Power connector, although it is insulated when the instrument is operating with batteries.



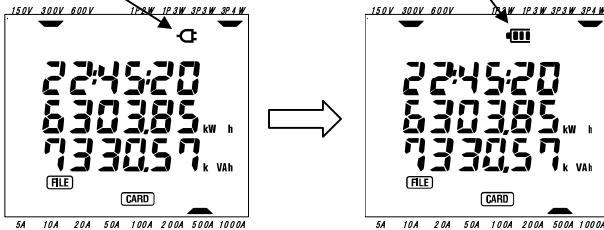

Measurement screen on each range switches as follows.

<AC power supply-operated> <Battery-operated>
 AC power supply mark  lights up Battery mark  lights up



- Battery condition

Battery mark varies as follows depending on the battery condition.

Mark	Description	
	Can perform measurement for about 4 to 7 hours	NOTE: Lighting up the backlight gets the battery life shortened.
	2 to 4 hours of measurement	
	0 to 2 hours of measurement	
	Battery is exhausted. (accuracy cannot be guaranteed) Following operations shall be done. * When saving the measured instantaneous value(file is opened), close a file. (Data will be saved) * During integration/demand measurement Stop the measurement forcefully. (Data will be saved)	

NOTE







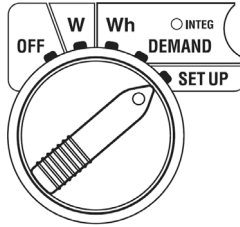

- * Batteries are not set in the instrument at the time of purchase. Please set the supplied batteries to the instrument. In case that the instrument will not be in use for a long period, place it in the storage after removing the batteries. For further details, please refer to “12-2 Battery replacement” in this manual.
- * When the instrument is powered by AC power supply, it doesn't operate with batteries.
- * If batteries are not set in the instrument and the supply from AC power supply stops, instrument is turned off and the data in measurement will be lost.

4. Setting

Following explains about settings for measurement condition and data saving.
Please set the Function switch to **SET UP** range as follows.







- Key operation

Keys		Details
	START/STOP key	No use
	BACKLIGHT key	Switches on/off the backlight of the LCD.
	UP & DOWN cursor key	<ul style="list-style-type: none"> * To switch the view for setting items. * To change the details of settings. * To change numbers.
	LEFT & RIGHT cursor key	<ul style="list-style-type: none"> * To switch the view for setting items. * To change the details of settings. * To select digits.
	ENTER key	<ul style="list-style-type: none"> * To select/ enter settings. * On the necessary setting item, press this key. Then instrument gets setting change mode and present set value will blink.
	ESC key	<ul style="list-style-type: none"> * To cancel settings. * Pressing this key releases setting change mode while the instrument is in setting change mode.
	DATA HOLD key	Data hold function is disabled.
		Pressing this key for 2 sec. or more disables all key operations.
	SAVE key	No use

4-1 List of setting items

List of setting items on **SET UP** range (25 items in total)

Item No.	Setting item	Mark	Initial value	Clause
01	Wiring	-	3P3W	4-3-1
02	Voltage range	-	300V	4-3-2
03	Current range	-	200A	4-3-3
04	Clamp sensor		500A	4-3-4
05	VT ratio	VT	1	4-3-5
06	CT ratio	CT	1.00	4-3-6
07	Time		-	4-3-7
08	Buzzer		on	4-3-8
09	Integration interval	INTEG INT	30 min.	4-3-9
10	Integration start date & time	INTEG START	Time	4-3-10
11	Integration stop date & time	INTEG STOP	Time + Interval	4-3-11
12	Reset of integration value	INTEG RESET	oFF (not reset)	4-3-12
13	Demand Interval	DEMAND INT	30 min.	4-3-13
14	Demand start date & time	DEMAND START	Time	4-3-14
15	Demand stop date & time	DEMAND STOP	Time + Interval	4-3-15
16	Demand target value	DEMAND Target	100kW	4-3-16
17	Demand inspection cycle	DEMAND 	10 min.	4-3-17
18	Reset of demand value	DEMAND RESET	oFF (not reset)	4-3-18
19	Use of CF card	CARD	-	4-3-19
20	Formatting CF card		oFF (not format)	4-3-20
21	Deleting the data in CF card		not.dEL (not delete)	4-3-21
22	Deleting the data in internal memory	MEM	not.dEL (not delete)	4-3-22
23	System reset	RESET	oFF (not reset)	4-3-23
24	Loading settings	CONF	-	4-3-24
25	Saving settings		-	4-3-25

Hereinafter, each setting is called as "Setting XX".

NOTE

* For setting item 12, 18, 20,21,22 and 23, last operations aren't kept, and the initial values are always in effective. Please refer to the setting procedure of each setting item.

4-2 Classification of setting items

- **Basic setting**

These are the basic settings for measurement of instantaneous value, integration value and demand value.

- “Setting 01” Wiring
- “Setting 02” Voltage range
- “Setting 03” Current range
- “Setting 04” Clamp sensor
- “Setting 05” VT ratio (if necessary)
- “Setting 06” CT ratio (if necessary)

- **Setting only for integration measurement** <only at integration value measurement>

- “Setting 09” Integration interval
- “Setting 10” Integration start date and time
(To start measurement at the set date and time)
- “Setting 11” Integration stop date and time
(To stop measurement at the set date and time)
- “Setting 12” Reset of integration value

- **Setting only for demand measurement** <only at demand value measurement>

- “Setting 13” Demand interval
- “Setting 14” Demand start date and time
(To start measurement at the set date and time)
- “Setting 15” Demand stop date and time
(To stop measurement at the set date and time)
- “Setting 16” Demand target value
- “Setting 17” Demand inspection cycle
- “Setting 18” Reset of demand value

- **Setting only for CF card**

- “Setting 19” Use of CF card
- “Setting 20” Formatting CF card
- “Setting 21” Deleting the data in CF card

- **Others**

- “Setting 07” Time
- “Setting 08” Buzzer
- “Setting 22” Deleting the data in internal memory
- “Setting 23” System reset
- “Setting 24” Loading settings
- “Setting 25” Saving settings

4-3 Setting procedure of each setting item

NOTE

During the integration/demand measurement or in stand-by mode, the settings can be viewed only for checking and cannot be changed.

- (1) Item number selection screen (hereinafter, called selection screen)

- * Set the Function switch to **SET UP** range.

- * Then selection screen is brought up, and "SET" mark and item number appear.

- * When turning on the instrument, setting screen for; "Setting 01": Wiring, is brought up. (see the right figure)

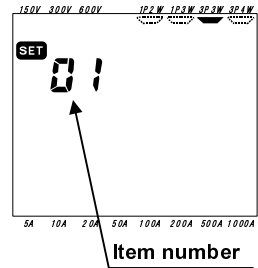

- (2) Item number selection

- * Press the **Cursor** key and select the desired item.

- * Item number changes in following sequence.

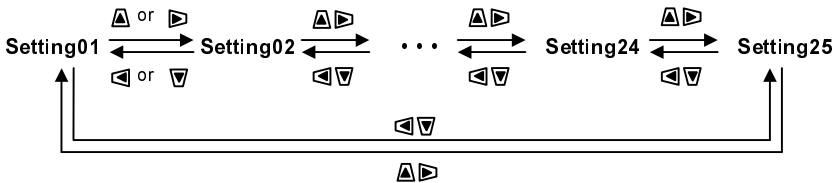

- (3) Change of setting item

- * Select the item number subject to change, press the **ENTER** key to get the instrument into setting change mode.

- * When the instrument is in setting change mode, previous set value or the initial value will blink.

- * Press the **Cursor** key and select the item to be changed.

- * Press the **ENTER** key to make the change effective.

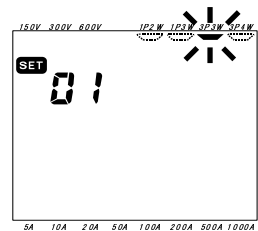

- (4) Cancel of settings

- * Press the **ENTER** key while the instrument is in setting change mode. Then setting change mode is released, and the setting returns to the previous one.

NOTE

- * Basically, last settings are kept.

4-3-1 “Setting 01” Wiring

Following explains how to set wiring.

Setting item	1P2W(1ch)	: Single-phase 2-wire (1ch)
	1P2W(2ch)	: Single-phase 2-wire (2ch)
	1P2W(3ch)	: Single-phase 2-wire (3ch)
	1P3W	: Single-phase 3-wire
	3P3W	: Three-phase 3-wire
	3P4W	: Three-phase 4-wire
Initial value or after system reset		3P3W

- * Press the **Cursor** key on the selection screen, and select “Setting 01”.
- * Then press the **ENTER** key to get the instrument into setting change mode.
- * Previous setting (initial value: 3P3W) blinks. Select the appropriate wiring with the **Cursor** key, and then press the **ENTER** key.

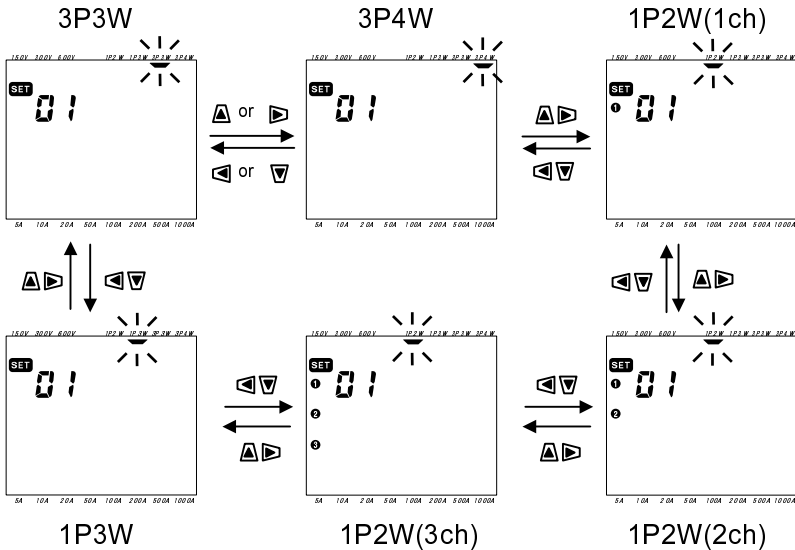

4-3-2 “Setting 02” Voltage range

Following explains how to set voltage measurement range.

Setting item	150V/ 300V/ 600V	
Initial value or after system reset	300V	

- * Press the **Cursor** key on the selection screen, and select “Setting 02”.
- * Then press the **ENTER** key to get the instrument into setting change mode.
- * Previous setting (initial value: 300V) blinks. Select the appropriate voltage range with the **Cursor** key, and then press the **ENTER** key.

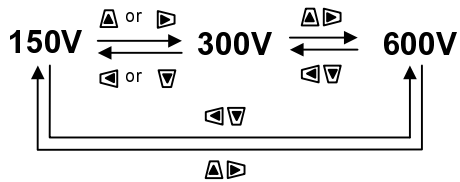
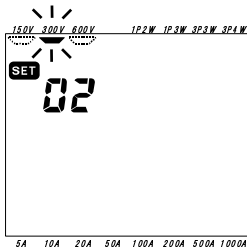

4-3-3 “Setting 03” Current range

Following explains how to set current measurement range.

Current range varies depending on the selected Clamp sensor at “Setting 04”.

Clamp sensor (“Setting 04”)	Current range
50A	5A / 10A / 20A / 50A
100A	10A / 20A / 50A / 100A
200A	20A / 50A / 100A / 200A
500A	50A / 100A / 200A / 500A
1000A	100A / 200A / 500A / 1000A
3000A	1000A / 3000A (*)
Initial value or after system reset	200A

* On 3000A range, CT ratio (“Setting 06”) has been set to 3.00.

- * Press the **Cursor** key on the selection screen, and select “Setting 03”.
- * Then press the **ENTER** key to get the instrument into setting change mode.
- * Previous setting (initial value: 200A) blinks. Select the appropriate current range with the **Cursor** key, and then press the **ENTER** key.

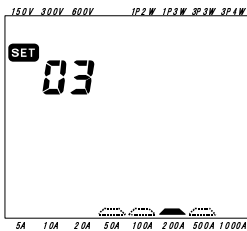

<When 500A type of clamp sensor is selected at “Setting 04”>

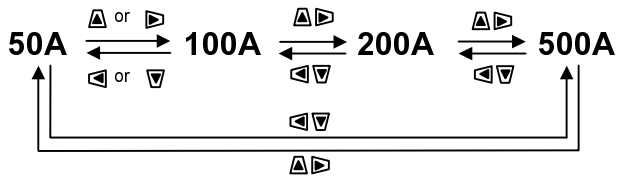

NOTE

- * When a type of clamp sensor (“Setting 04”) is changed, current range may be changed to the corresponding range automatically.
- * When the Clamp sensor in use is different from the setting for the sensor made at “Setting 04”, correct measured value cannot be obtained.

4-3-4 “Setting 04” Clamp sensor

Following explains how to set clamp sensor.



Current range (“Setting 03”) varies depending on the selected Clamp sensor.

Clamp sensor	Current range (“Setting 03”)
50A	5A / 10A / 20A / 50A
100A	10A / 20A / 50A / 100A
200A	20A / 50A / 100A / 200A
500A	50A / 100A / 200A / 500A
1000A	100A / 200A / 500A / 1000A
3000A	1000A / 3000A
Initial value or after system reset	500A

- * Press the **Cursor** key on the selection screen, and select “Setting 04”.
- * Then press the **ENTER** key to get the instrument into setting change mode.
- * Previous setting (initial value: 500A clamp sensor) blinks. Select the appropriate clamp sensor with the **Cursor** key, and then press the **ENTER** key.

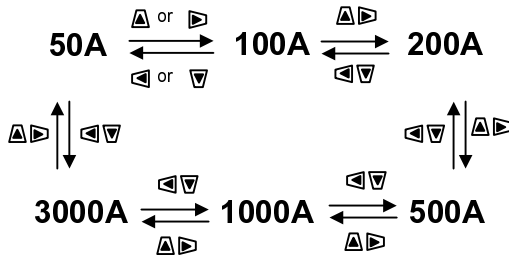
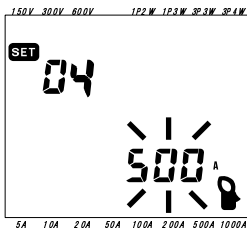

NOTE

- * When a type of clamp sensor is changed, current range (“Setting 03”) may be changed to the corresponding range automatically.
- * When the Clamp sensor in use is different from the setting for the sensor, correct measured value cannot be obtained.
- * Lineup of Clamp sensors has not been completed yet. For further information about Clamp sensor, please contact the distributor from who purchased the instrument.

4-3-5 “Setting 05” VT ratio

Following explains how to set VT ratio.



For the detailed information about VT ratio, please refer to “5-3 VT/CT” in this manual.

Setting range	1 ~ 10000
Initial value or after system reset	1

- * Press the **Cursor** key on the selection screen, and select “Setting 05”.
- * Then press the **ENTER** key to get the instrument into setting change mode.
- * The rightmost digit of previous setting (initial value: 00001) blinks.
- * Change the number with the **Cursor** key, and then press the **ENTER** key.

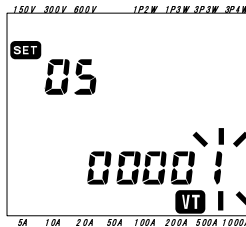

Function of **Cursor** keys

	To select the digit subject to change.
	To change the number of selected digit.

When VT ratio is set to other than 1, “**VT**” mark appears on each measurement screen.

NOTE

- * When 0 is set as a VT ratio, it is forcefully changed to 1.
In case that the value of 10000 or more is set, it is forcefully changed to 10000.
- * Following value cannot be set as a VT ratio. A message “**SEtErr**” is displayed on the LCD, and the value returns to the previous set value.
(Voltage range “**Setting 02**”) x 120% x (Current range “**Setting 03**”) x 120% x (VT ratio) x (CT ratio “**Setting 06**”) > 9999G (G=10⁹)

4-3-6 “Setting 06” CT ratio

Following explains how to set CT ratio.

CT

For the detailed information about CT ratio, please refer to “5-3 VT/CT” in this manual.

Setting range	1.00 ~ 10000.0
Initial value or after system reset	1.00

- * Press the **Cursor** key on the selection screen, and select “Setting 06”.
- * Then press the **ENTER** key to get the instrument into setting change mode.
- * The rightmost digit of previous setting (initial value: 1.00) blinks.
- * Change the number with the **Cursor** key, and then press the **ENTER** key.

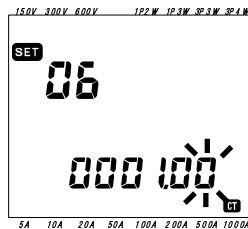

Function of **Cursor** keys

	To select the digit subject to change.
	To change the value of selected digit.

When CT ratio is set to other than 1.00, “**CT**” mark appears on the measurement screen.

NOTE

- * When a value between 0.00 ~ 0.99 is set as a CT ratio, it is forcefully changed to 1.00. In case that the value of 10000 or more is set, it is forcefully changed to 10000.
- * When 3000A of clamp sensor is selected at “Setting 04”, and Current range is set to 3000A at “**Setting 03**”, the CT ratio is 3.00.
- * If the setting of Clamp sensor (“**Setting 04**”) is changed after setting the CT ratio, the ratio returns to 1.00.
- * Following value cannot be set as a CT ratio. A message “**SELErr**” is displayed on the LCD, and the value returns to the previous set value.
 $(\text{Voltage range “Setting 02”} \times 120\% \times (\text{Current range “Setting 03”} \times 120\% \times (\text{VT ratio “Setting 05”} \times (\text{CT ratio}) > 9999\text{G} (\text{G} = 10^9)))$

4-3-7 “Setting 07” Time

Following explains how to set time.



- * Press the **Cursor** key on the selection screen, and select “Setting 07”.
- * Then press the **ENTER** key to get the instrument into setting change mode.
- * Then minute blinks as follows. Select the time parameter to be changed with Left & Right **Cursor** key and change it with Up & Down **Cursor** key.
- * Then press the **ENTER** key.

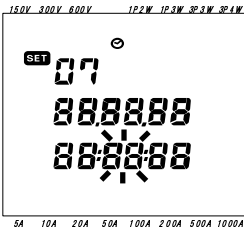

Time parameter	Setting range
second	Cannot be set (*1)
minute	00 ~ 59
hour	00 ~ 23
day	01 ~ 31 (*2)
month	01 ~ 12
year	00 ~ 99 (*3)

(*1) It is forcefully changed to 00.

(*2) You cannot select the day that does not exist. If such a day is selected, it will be automatically changed into 01.

(*3) For the year, please set last 2 digits. (e.g. 2004 → 04)

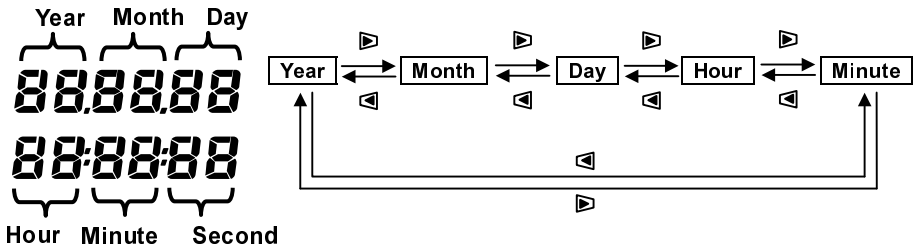

Function of **Cursor** keys

	To select a time parameter subject to change.
	To change the number of selected time parameter.

4-3-8 “Setting 08” Buzzer

Following explains how to set buzzer.



- * Press the **Cursor** key on the selection screen, and select “Setting 08”.
- * Then press the **ENTER** key to get the instrument into setting change mode.
- * Previous setting (initial value: on) blinks. Press the **Cursor** key to select on (sound) or off(not sound).
- * Then press the **ENTER** key.

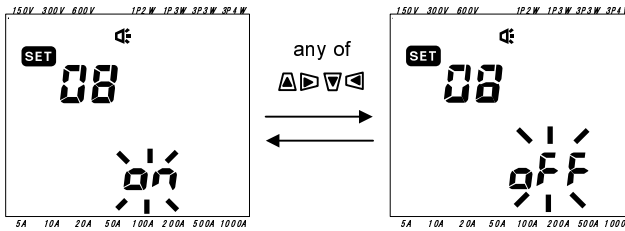

4-3-9 “Setting 09” Integration interval

Following explains how to set the Integration interval.



Integration interval is an interval to save the measured data at integration measurement into CF card or internal memory.

Setting time	1/ 2/ 5/ 10/ 15/ 20/ 30 sec. 1/ 2/ 5/ 10/ 15/ 20/ 30 min. 1 hour
Initial value or after system reset	30 min.

- * Press the **Cursor** key on the selection screen, and select “Setting 09”.
- * Then press the **ENTER** key to get the instrument into setting change mode.
- * Previous setting (initial value: 30 min.) blinks. Press the **Cursor** key to select any desired interval.
- * Then press the **ENTER** key.

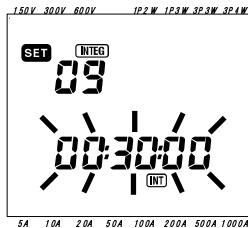

4-3-10 “Setting 10” Integration start date and time

Following explains how to set Integration start date and time.



- * Press the **Cursor** key on the selection screen, and select “Setting 10”.
- * Then press the **ENTER** key to get the instrument in setting change mode.
- * Time (“**Setting 07**”); 1 min. put forward on (second is rounded up), is displayed on the LCD, and second will blink.
- * Change the time with the **Cursor** key, and then press the **ENTER** key.

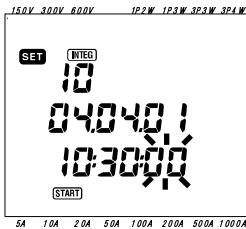

Time parameter	Setting range
second	00 ~ 59
minute	00 ~ 59
hour	00 ~ 23
day	01 ~ 31 (*1)
month	01 ~ 12
year	00 ~ 99 (*2)

- (*1) If the day that does not exist is selected, a message “**SELEEr**” is displayed on the LCD, and then it returns to previous set value.
- (*2) For the year, please set last 2 digits. (e.g. 2004 → 04)

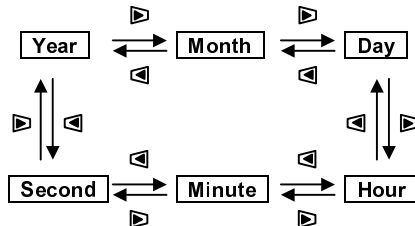
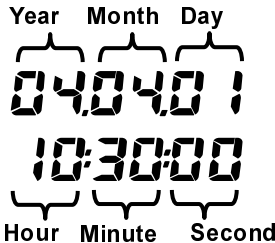

Function of **Cursor** keys

	To select the time parameter subject to change.
	To change the number of selected time parameter.

NOTE

- * Start time can be set to the past time, but integration measurement starts right after pressing the **STRAT/STOP** key on **Wh** range. For more detailed information, please refer to “**Section 7: Integration value measurement**” in this manual.

4-3-11 “Setting 11” Integration stop date and time

Following explains how to set integration stop date and time.



- * Press the **Cursor** key on the selection screen, and select “Setting 11”.
- * Then press the **ENTER** key to get the instrument into setting change mode.
- * Date and time; Integration start date and time (“**Setting 10**”) plus Integration interval (“**Setting 09**”), is displayed on the LCD, and second will blink.
- * Press the **Cursor** key to set any desired time, and then press the **ENTER** key.

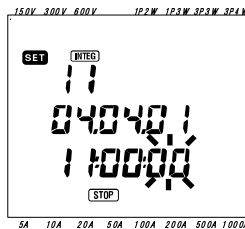

For further details, please kindly refer to Integration start date and time (“**Setting 10**”) in this manual.

NOTE

- * Period between start and stop time of integration measurement can be set to shorter than the integration interval (“**Setting 09**”). However, the measured data will not be recorded.

4-3-12 “Setting 12” Reset of integration value

Following explains how to reset the integration value.



When previous integration value is not necessary, please reset it as follows.

- * Press the **Cursor** key on the selection screen, and select “Setting 12”.
- * Then press the **ENTER** key to get the instrument in setting change mode.
- * On the LCD, “oFF”(not reset) will blink. Then change it to “on”(reset) with **Cursor** key.
- * Then press the **ENTER** key.

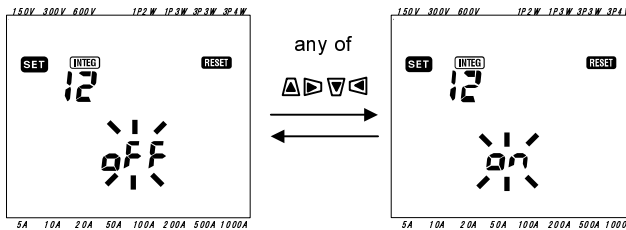

NOTE

- * This setting is also available on **Wh** range.
For further details, please refer to “**Section 7: Integration value measurement**” in this manual.
- * When a new integration measurement is made with the previous integration value kept, you do not have to do this setting.
- * In order to prevent operation mistake, the initial value is always “oFF”.

4-3-13 “Setting 13” Demand interval

Following explains how to set the demand Interval.



Demand interval is an interval to save the measured data at demand measurement into CF card or internal memory.

Setting time	1/ 2/ 5/ 10/ 15/ 20/ 30 sec. 1/ 2/ 5/ 10/ 15/ 20/ 30 min. 1 hour
Initial value or after system reset	30 min.

- * Press the **Cursor** key on the selection screen, and select “Setting 13”.
- * Then press the **ENTER** key to get the instrument in setting change mode.
- * Previous setting (initial value: 30 min.) blinks. Press the **Cursor** key to select any desired interval.
- * Then press the **ENTER** key.

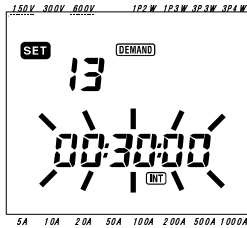

4-3-14 “Setting 14 Demand start date and time

Following explains how to set demand start date and time.



- * Press the **Cursor** key on the selection screen, and select “Setting 14”.
- * Then press the **ENTER** key to get the instrument in setting change mode.
- * Time (“Setting 07”); 1 min. put forward on (second is rounded up), is displayed on the LCD, and second will blink.
- * Change the time with the **Cursor** key, and then press the **ENTER** key.

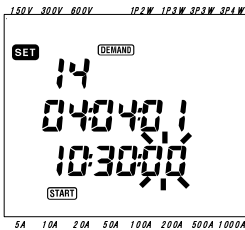

Time parameter	Setting range
second	00 ~ 59
minute	00 ~ 59
hour	00 ~ 23
day	01 ~ 31 (*1)
month	01 ~ 12
year	00 ~ 99 (*2)

- (*1) If the day that does not exist is selected, a message “SEtErr” is displayed on the LCD, and then it returns to previous set value.
- (*2) For the year, please set last 2 digits. (e.g. 2004 → 04)

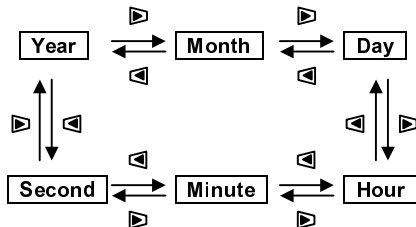

Function of **Cursor** keys

	To select the time parameter subject to change.
	To change the number of selected time parameter.

4-3-15 “Setting 15” Demand stop date and time

Following explains how to set demand stop date and time.



- * Press the **Cursor** key on the selection screen, and select “Setting 15”.
- * Then press the **ENTER** key to get the instrument in setting change mode.
- * Date and time; demand start date and time (“**Setting 14**”) plus demand interval (“**Setting 13**”), is displayed on the LCD, and second will blink.
- * Change the time with the **Cursor** key, and then press the **ENTER** key.

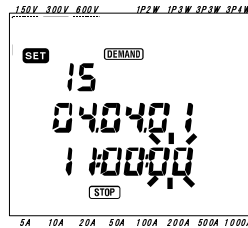

For further details, please kindly refer to demand start date and time (“**Setting 14**”) in this manual.

NOTE

- * Period between start and stop time of demand measurement can be set to shorter than the demand interval (“**Setting 13**”). However, the measured data will not be recorded.

4-3-16 “Setting 16” Demand target value

Following explains how to set the demand target value.

DEMAND Target

For further details about demand target value, please refer to “Section 8: Demand value measurement” in this manual. Target value can be set between 0.1W and 999.9GW.

Demand target value	0.1 ~ 999.9	W
	0.1 ~ 999.9	kW
	0.1 ~ 999.9	MW
	0.1 ~ 999.9	GW
Initial value or after system reset	100.0kW	

- * Press the **Cursor** key on the selection screen, and select “Setting 16”.
- * Then press the **ENTER** key to get the instrument in setting change mode.
- * Previous setting (initial value: 100.0kW) blinks. Press the **Cursor** key to set any desired value and unit.
- * Then press the **ENTER** key.

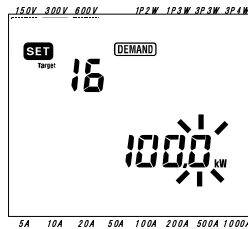

Function of **Cursor** keys

◀ ▶	To select the digit or unit parameter subject to change.
▲ ▼	To change the number of selected digit or unit.

NOTE

- * When the target value is set to 0, it is forcefully changed into 100.0.

4-3-17 “Setting 17” Demand inspection cycle

Following explains how to set the Demand inspection cycle.



For the information about Demand inspection cycle, please refer to “Section 8: Demand measurement” in this manual.

According to the demand interval, which has been set at “Setting 13”, inspection cycle can be set as follows.

Demand interval (“Setting 13”)	Inspection cycle
1 sec./ 2 sec./ 5 sec.	Cannot be set.
10 sec.	1 sec./ 2 sec./ 5 sec.
15 sec.	2 sec./ 5 sec./ 10 sec.
20 sec.	5 sec./ 10 sec./ 15 sec.
30 sec.	10 sec./ 15 sec./ 20 sec.
1 min.	15 sec./ 20 sec./ 30 sec.
2 min.	20 sec./ 30 sec./ 1 min.
5 min.	30 sec./ 1 min./ 2 min.
10 min.	1 min./ 2 min./ 5min.
15 min.	2 min./ 5min./ 10 min.
20 min.	5min./ 10 min./ 15 min.
30 min.	10 min./ 15 min./ 20 min.
1 hour	15 min./ 20 min./ 30min.
Initial value or after system reset	10 min.

- * Press the **Cursor** key on the selection screen to select “Setting 17”.
- * Then press the **ENTER** key to get the instrument in setting change mode.
- * Previous setting (initial value: 10 min.) blinks. Press the **Cursor** key, and select any desired cycle. Then press the **ENTER** key.

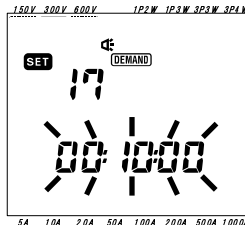

4-3-18 “Setting 18” Reset of demand value

Following explains how to reset the demand value.



The demand value recorded in the previous demand measurement can be reset as follows.

- * Press the **Cursor** key on the selection screen, and select “Setting 18”.
- * Then press the **ENTER** key to get the instrument in setting change mode.
- * On the LCD, “oFF” (not reset) will blink. Then change it to “on”(reset) with **Cursor** key, and then press the **ENTER** key.

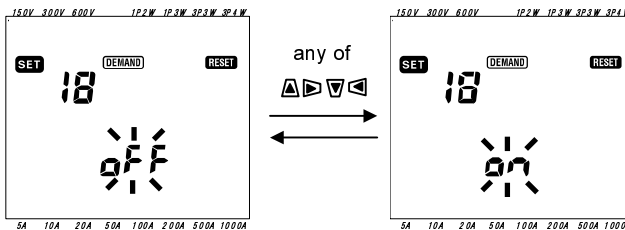

NOTE

- * This setting is also available on **DEMAND** range.
For more detailed information, please refer to “**Section 8: Demand value measurement**” in this manual.
- * When the demand value is reset, integration value will be also reset.
- * In order to prevent operation mistake, the initial value is always “oFF”.

4-3-19 “Setting 19” Use of CF card



Following explains how to use CF card.

For more detailed information about CF card, please refer to “Section 9: Specification of CF card/Internal memory” in this manual.

CAUTION

Be sure to set the Function switch to OFF position before placing/removing a CF card. If a CF card is placed/removed while the instrument is on, saved data or instrument may be damaged.

- * Press the **Cursor** key on the selection screen, and select “Setting 19”.
Then press the **ENTER** key to get the instrument in setting change mode.

<When CF card is placed in the instrument>

- * On the LCD, “rEC.on” is displayed. (“on” (using a CF card) will blink)
- * When the measured data is saved to the CF card, you do not have to do this setting. When the measured data is saved to the internal memory, press **Cursor** key to change the indication into “oFF”. (“oFF”: Not using a CF card)
- * Then press the **ENTER** key.

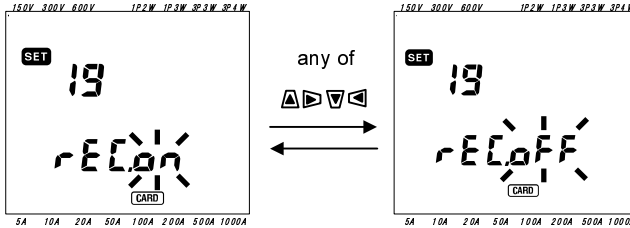

<When CF card is not placed in the instrument>

- * On the LCD, “rEC.oFF” is displayed. (“oFF” will blink). You cannot change it into “on”. The measured data is saved to the internal memory.
- * When saving the measured data in CF card, first set the Function switch to OFF position, and then place a CF card into the instrument and do setting.

NOTE

- * Instrument automatically identifies a CF card when it is turned on.
- * Be sure to verify proper operation of CF card on a well-known hardware.
- * As to the manipulation of the CF card, please refer to the instruction manual attached to the card.

4-3-20 “Setting 20” Formatting CF card



Following explains how to format a CF card

Newly purchased CF card must be formatted before use.

For more detailed information about CF card, please refer to “Section 9: Specification of CF card/Internal memory” in this manual.

⚠ CAUTION

Be sure to set the Function switch to OFF position before placing/removing a CF card. If a CF card is placed/removed while the instrument is on, saved data or instrument may be damaged.

- * Be sure to confirm the Function switch is at OFF position.
Then place a CF card into the CF card connector of the instrument.
- * Set the Function switch to **SET UP** range.
- * On the selection screen, select “Setting 20” with **Cursor** key.
- * Then press the **ENTER** key to get the instrument in setting change mode.
- * The message “oFF”(not format) will blink. Change it to “on”(format) with **Cursor** key. In case that CF card is not placed in the instrument, you cannot set it to “on”.)

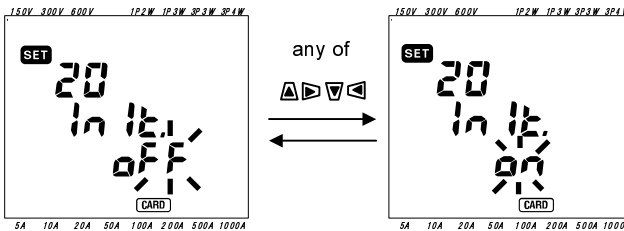

When pressing the **ENTER** key, format will start. Formatting takes a few seconds. After formatting, a message “InIt FlnSh” is displayed on the LCD.

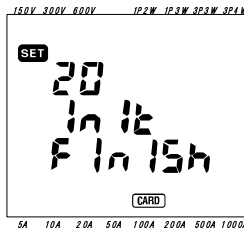

NOTE

- * All data in the CF card will be deleted after formatting.
- * Instrument automatically identifies a CF card when it is turned on.
- * Be sure to verify proper operation of CF card on a well-known hardware.
- * As to the manipulation of the CF card, please refer to the instruction manual attached to the card.
- * In order to prevent operation mistake, the initial value is always “oFF” (not format).

4-3-21 “Setting 21” Deleting the data in CF card

Following explains how to delete the data in CF card.

CARD

For more detailed information about CF card, please refer to “**Section 9: Specification of CF card/Internal memory**” in this manual.

CAUTION

Be sure to set the Function switch to OFF position before placing/removing a CF card. If a CF card is placed/removed while the instrument is on, saved data or instrument may be damaged.

- * Be sure to confirm the Function switch is at OFF position, and then place a CF card into the CF card connector of the instrument.
- * Set the Function switch to **SET UP** range.
- * Press the **Cursor** key on the selection screen, and select “Setting 21”.
- * Then press the **ENTER** key to get the instrument in setting change mode.
- * The message “not.dEL”(not delete) will blink. Change it to “dEL”(delete) with **Cursor** key. (In case that CF card is not placed in the instrument, you cannot select “dEL”.)
- * When pressing the **ENTER** key, the data is deleted. It takes a few minutes to delete the data.

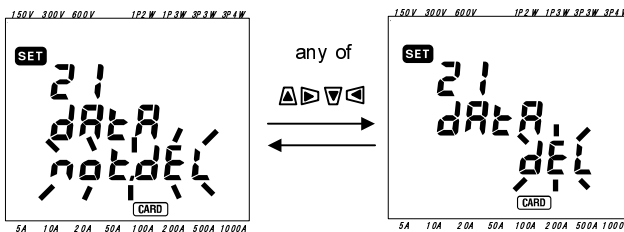

NOTE

- * Instrument automatically identifies a CF card when it is turned on.
- * Be sure to verify proper operation of CF card on a well-known hardware.
- * As to the manipulation of the CF card, please refer to the instruction manual attached to the card.
- * In order to prevent operation mistake, initial value is always “not.dEL”.

4-3-22 “Setting 22” Deleting the data in internal memory

Following explains how to delete the data in the internal memory.



For more detailed information about internal memory, please refer to “Section 9: Specification of CF card/ Internal memory” in this manual.

- * Press the **Cursor** key on the selection screen, and select “Setting 22”.
- * Then press the **ENTER** key to get the instrument in setting change mode.
- * The message “not.dEL”(not delete) will blink. Change it to “dEL”(delete) with **Cursor** key.
- * When pressing the **ENTER** key, the data is deleted.

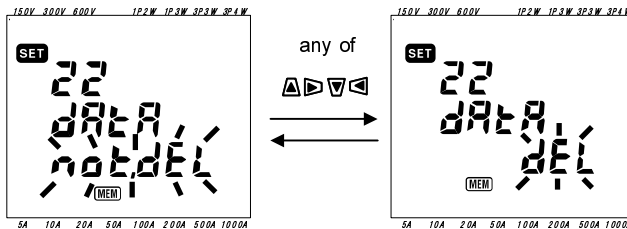

NOTE

- * In order to prevent operation mistake, initial value is always “not.dEL”.

4-3-23 “Setting 23” System reset

Following explains how to do system reset.

RESET

For further details about system reset, please refer to “**Section 11: Other functions**” in this manual.

- * Press the **Cursor** key on the selection screen, and select “Setting 23”.
- * Then press the **ENTER** key to get the instrument in setting change mode.
- * The message “oFF”(not reset) will blink. Change it to “on”(reset) with **Cursor** key.
- * When pressing the **ENTER** key again, system reset is done.

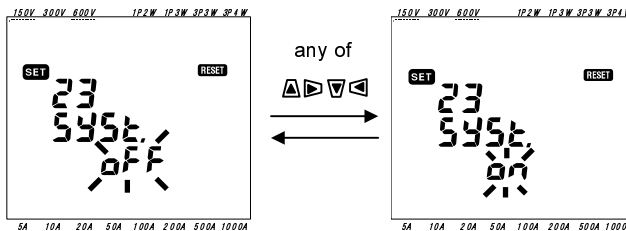

NOTE

- * In order to prevent operation mistake, initial value is always “not.dEL”.

4-3-24 “Setting 24” Loading settings

Following explains how to load the settings saved at “Setting 25”.



Please refer to “Setting 25” in which shows how to save the setting.

- * Press the **Cursor** key on the selection screen, and select “Setting 24”.
- * Then press the **ENTER** key to get the instrument in setting change mode.
- * Select any saving number between 01 and 20 with **Cursor** key.
- * Then press the **ENTER** key.

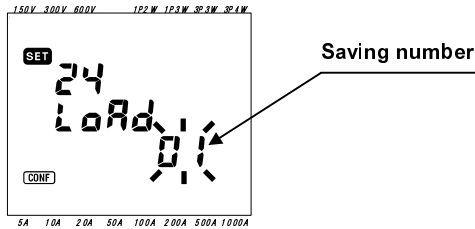

NOTE

- * When loading the saving number on which no setting has not been made at “Setting 25”, each setting (7 items) listed in the table on the next page returns to initial values.

4-3-25 “Setting 25” Saving settings

Following explains how to save the setting items.



Seven items below can be saved.

Making necessary settings on following 7 items, and save them.

Then it can be loaded from “Setting 24” from the next time.

Selectable number: 01 ~ 20

Item number	
Setting 01	Wiring
Setting 02	Voltage range
Setting 03	Current range
Setting 04	Clamp sensor
Setting 05	VT ratio
Setting 06	CT ratio
Setting 08	Buzzer

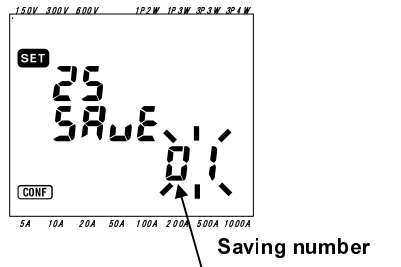

Section 4

* Above 7 items are set when needed.

(Please refer to each setting procedure.)

- * Press the **Cursor** key on the selection screen, and select “Setting 25”.
- * Then press the **ENTER** key to get the instrument in setting change mode.
- * Select any saving number between 01 and 20 with **Cursor** key.
- * Then press the **ENTER** key.

NOTE

- * When new settings are made on the saving number on which settings already have done, the previous setting will be overwritten.
- * Saving number can be selected between 01 and 20.
- * The items saved on each saving number returns to initial value after system reset.

5. Wiring

Following explains about wiring.

5-1 Check prior to do wiring

- Please be sure to check following things.

DANGER

- Never make measurement on the circuit in which electrical potential over AC600V exists.
- Be sure to connect the Power cord to an outlet. Moreover, never make measurement on the circuit in which electrical potential over AC240V exists.
- Make sure that Clamp sensor, Voltage test leads and Power cord are connected to the instrument first.
- Do not connect the Voltage test leads or Clamp sensors to the input terminal, which are not used at measurement.
- Input of this instrument shall be connected to the secondary side of circuit breaker. Current capacity at the primary side is big, and it is dangerous.
- Do not open-circuit the secondary side of CT while it is energized. If it is open-circuited, high voltage is generated at the secondary side, and extreme danger is caused.
- Be careful not to short-circuit the power line with the tip of metal parts of the Voltage test leads at wiring. Transformer jaw tips are designed not to short the circuit under test. If equipment under test has exposed conductive parts, however, extra precaution should be taken to minimize the possibility of shorting.

WARNING

- In order to avoid possible electric shock and short-circuit, be sure to turn off the line under test when connecting the test leads.
- Never touch the metal tip of Voltage test leads.

- For correct measurement:

With this instrument, be sure to select the appropriate wiring against the line under test. Make sure that the arrow mark on the Clamp sensor faces to load side.

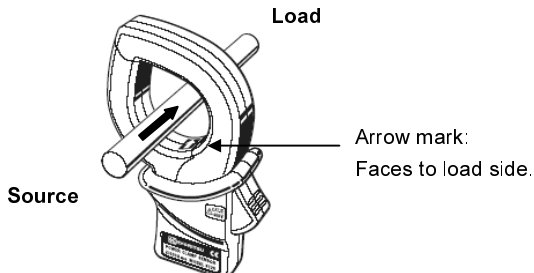

5-2 Basic wiring method

Following explains about basic wiring method.

- Wiring method for single-phase 2-wire (1ch) "1P2W (1ch)"

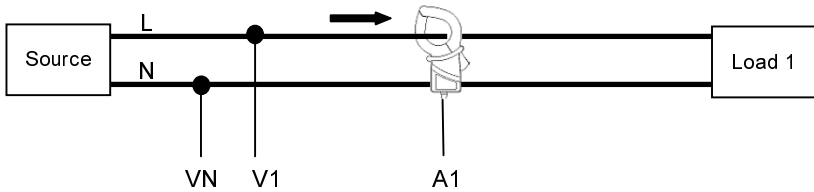

- Wiring method for single-phase 2-wire (2ch) "1P2W (2ch)"

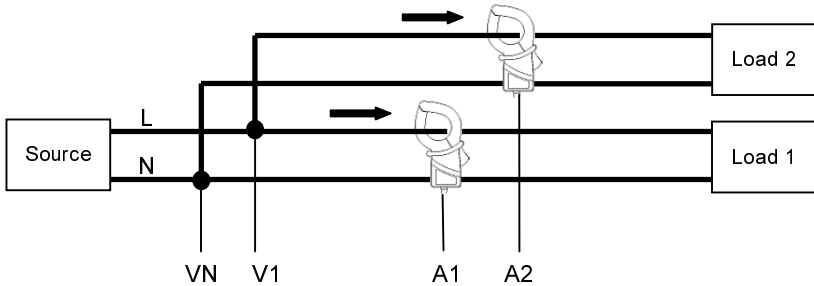

- Wiring method for single-phase 2-wire (3ch) "1P2W (3ch)"

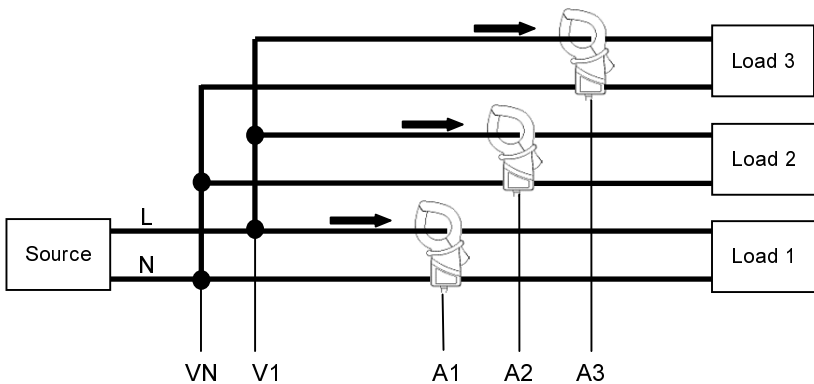

- Wiring method for single-phase 3-wire "1P3W"

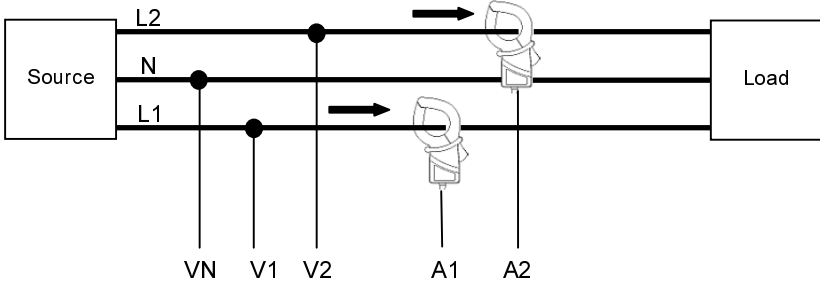

- Wiring method for three-phase 3-wire "3P3W"

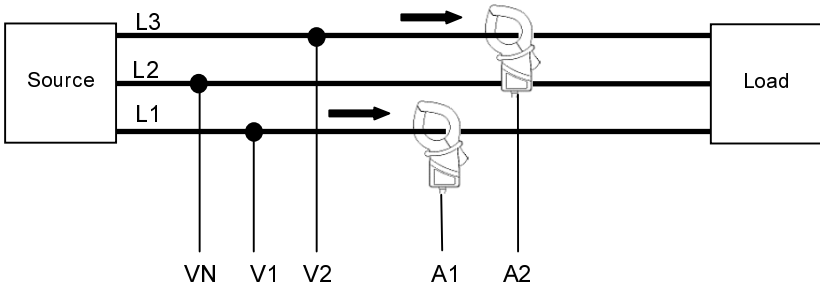

- Wiring method for three-phase 4-wire "3P4W"

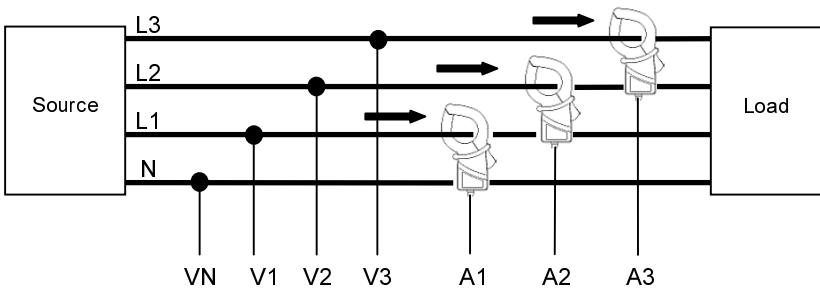

5-3 VT/ CT

Following explains about VT (transformer) / CT (current transformer).

⚠ DANGER

- Never make measurement on the circuit in which electrical potential over AC600V exists.
- Be sure to connect the Power cord to an outlet. Moreover, never make measurement on the circuit in which electrical potential over AC240V exists.
- This instrument must be used at the secondary side of VT(transformer) and CT(current transformer).
- Be careful not to open-circuit the secondary side of CT while it is energized. If it is open-circuited, high-voltage is generated at the secondary side, and extreme danger is caused.

⚠ CAUTION

- The measurement accuracy when using a VT or CT is not guaranteed. When a VT or CT is used, accuracy of this instrument, VT and CT, moreover, phase characteristics shall be taken into consideration.

When the voltage or current value on the line under test exceeds the max measuring range of this instrument, the value at the primary side of circuit can be displayed by measuring the secondary side with appropriate VT and CT against the line under test as follows.

<Example of single-phase 2-wire (1ch) "1P2W(1ch)">

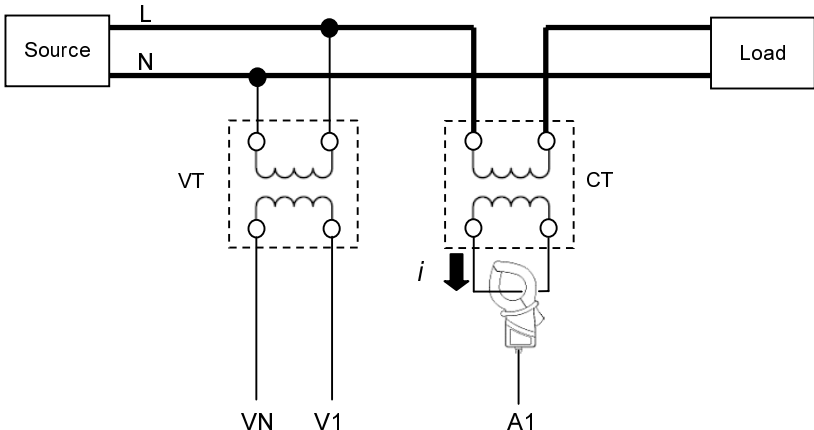

In this case, please set the actual ratio of VT and CT to be used.

* VT ratio: **"Setting 05"**

* CT ratio: **"Setting 06"**

6. Instantaneous value measurement

Following explains about instantaneous value measurement.

Set the Function switch to **W** range.

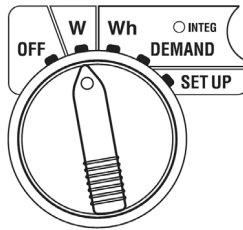

When Function switch is set to below position on measurement;

Wh range : No use

DEMAND range : No use

SET UP range : Change/ Confirm the settings
(see “Section 4: Settings”)

• Indications

Measurement/Calculation items			Unit
Voltage (RMS)	V : Average voltage of each phase	Vi : Voltage of each phase	V
Current (RMS)	A : Average current of each phase	Ai : Current of each phase	A
Active power	P : Total active power Polarity: + (no mark) consumption, - (minus) regenerating	Pi : Active power of each phase	W
Reactive power	Q : Total reactive power Polarity: + (no mark) delay phase, - (minus) advance phase	Qi : Reactive power of each phase	Var
Apparent power	S : Total apparent power	Si : Apparent power of each phase	VA
Power factor	PF : Power factor of whole system Polarity: + (no mark) delay phase, - (minus) advance phase	Pfi : Power factor of each phase	PF
Frequency	f : Frequency at V1		Hz
Neutral current	In : Current on a neutral line (only at three-phase 4-wire)		An

* i = 1, 2, 3

Displayed items can be changed according to needs.

Please refer to “6-3 Customizing display”.

NOTE

* Above measurement/calculation items vary depending on each wiring.

* When V1 is out of measuring range, each measurement/calculation may not be performed.





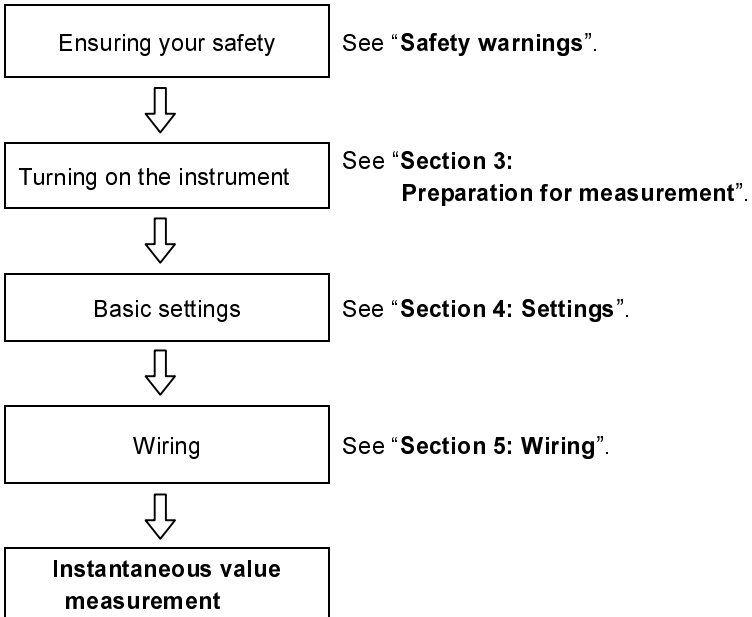



* The units for the power factor and neutral current are effective only for this instrument.

- Before making a measurement



- Basic settings
 - “**Setting 01**” Wiring
 - “**Setting 02**” Voltage range
 - “**Setting 03**” Current range
 - “**Setting 04**” Clamp sensor
 - “**Setting 05**” VT ratio (if necessary)
 - “**Setting 06**” CT ratio (if necessary)

- Keys

Key		Description
	START/STOP key	No use
	BACKLIGHT key	Switches on/off the backlight of the LCD.
	UP cursor key DOWN cursor key	Switches the display contents. Selects the row to be customized at display customize mode.
	LEFT cursor key RIGHT cursor key	Switches the display contents. Switches the selected item at display customize mode.
	ENTER key	Selects/Enters display customizing mode. Enters the decision to delete a file in the internal memory.
	ESC key	Cancels a setting on display customize mode.
	DATA HOLD key	Holds the indicated value on the LCD.
		Pressing this key for 2 sec. or more disables all key operations to prevent operation mistake during a measurement.
	SAVE key	Saves the measured data.

- Indication at no input

When no voltage and current are input, indication on the LCD will be as follows. Please refer to “6-5-2 Over-range indication/ Bar indication” in this manual.

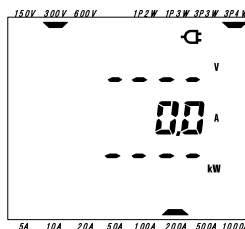

6-1 Wiring display screen

The start-up screen (or the screen after system reset) according to each wiring is listed below.

When turning the Function switch from “OFF” to **W** range, following measurement screen appears.

e.g. Three-phase 4-wire (Screen 1-A)

Screen 1-A (*)

		Screen A
Screen 1	Upper	V
	Middle	A
	Lower	P

* For further details about Screen 1-A, please refer to “6-2 Switching the display screen” in this manual.

•Single-phase 2-wire (1ch) “1P2W (1ch)” (9 screens)

		Screen A	Screen B	Screen C	Screen D	Screen E	Screen F	Screen G
Screen 1	Upper	V	-	-	-	-	-	-
	Middle	A	-	-	-	-	-	-
	Lower	P	-	-	-	-	-	-
Screen 2	Upper	P	-	-	-	-	-	-
	Middle	S	-	-	-	-	-	-
	Lower	PF	-	-	-	-	-	-
Screen 3	Upper	V	A	P	PF	S	Q	f
	Middle	-	-	-	-	-	-	-
	Lower	-	-	-	-	-	-	-

•Single-phase 2-wire (2ch) “1P2W (2ch)” (13 screens)

		Screen A	Screen B	Screen C	Screen D	Screen E	Screen F	Screen G
Screen 1	Upper	V	V	V	-	-	-	-
	Middle	A	A1	A2	-	-	-	-
	Lower	P	P1	P2	-	-	-	-
Screen 2	Upper	P	P1	P2	-	-	-	-
	Middle	S	S1	S2	-	-	-	-
	Lower	PF	PF1	PF2	-	-	-	-
Screen 3	Upper	V	A1	P1	PF1	S1	Q1	f
	Middle	-	A2	P2	PF2	S2	Q2	-
	Lower	-	-	-	-	-	-	-

●Single-phase 2-wire (3ch) “1P2W (3ch)”(15 screens)

		Screen A	Screen B	Screen C	Screen D	Screen E	Screen F	Screen G
Screen 1	Upper	V	V	V	V	-	-	-
	Middle	A	A1	A2	A3			
	Lower	P	P1	P2	P3			
Screen 2	Upper	P	P1	P2	P3	-	-	-
	Middle	S	S1	S2	S3			
	Lower	PF	PF1	PF2	PF3			
Screen 3	Upper	V	A1	P1	PF1	S1	Q1	f
	Middle	-	A2	P2	PF2	S2	Q2	-
	Lower	-	A3	P3	PF3	S3	Q3	-

●Single-phase 3-wire “1P3W”, Three-phase 3-wire “3P3W” (13 screens)

		Screen A	Screen B	Screen C	Screen D	Screen E	Screen F	Screen G
Screen 1	Upper	V	V1	V2	-	-	-	-
	Middle	A	A1	A2				
	Lower	P	P1	P2				
Screen 2	Upper	P	P1	P2	-	-	-	-
	Middle	S	S1	S2				
	Lower	PF	PF1	PF2				
Screen 3	Upper	V1	A1	P1	PF1	S1	Q1	f
	Middle	V2	A2	P2	PF2	S2	Q2	-
	Lower	-	-	-	-	-	-	-

●Three-phase 4-wire “3P4W” (15 screens)

		Screen A	Screen B	Screen C	Screen D	Screen E	Screen F	Screen G
Screen 1	Upper	V	V1	V2	V3	-	-	-
	Middle	A	A1	A2	A3			
	Lower	P	P1	P2	P3			
Screen 2	Upper	P	P1	P2	P3	-	-	-
	Middle	S	S1	S2	S3			
	Lower	PF	PF1	PF2	PF3			
Screen 3	Upper	V1	A1	P1	PF1	S1	Q1	f
	Middle	V2	A2	P2	PF2	S2	Q2	In
	Lower	V3	A3	P3	PF3	S3	Q3	-

NOTE

* Items on each screen can be changed.

Please refer to “6-3 Customizing the display” in this manual.

6-2 Switching the display screen

Following explains how to switch the display screens.

Display screens are classified as follows. Following table is also used in “**6-3 Customizing the display**”.

Screen 1 consists of Screen 1-A, 1-B, 1-C and 1-D.

Screen A consists of Screen 1-A, 2-A and 3-A.

Screen 2, 3 and Screen B to G are same to above.

	Screen A	Screen B	Screen C	Screen D	Screen E	Screen F	Screen G
Screen 1	Screen 1-A	Screen 1-B	Screen 1-C	Screen 1-D	—	—	—
Screen 2	Screen 2-A	Screen 2-B	Screen 2-C	Screen 2-D	—	—	—
Screen 3	Screen 3-A	Screen 3-B	Screen 3-C	Screen 3-D	Screen 3-E	Screen 3-F	Screen 3-G

* In case of single-phase 2-wire (1ch),

Following screens do not appear.



1-B, 1-C, 1-D, 2-B, 2-C, 2-D

* In case of single-phase 2-wire (2ch), single-phase 3-wire and three-phase 3-wire, following screens do not appear.

1-D and 2-D

- How to switch the display screens

When turning the Function Switch from “OFF” to **W** range, Screen 1-A appears. Using **Cursor** keys to switch Screen 1-A to others.

	Switches Screen A to G.
	Switches Screen 1 to 3.

NOTE

Turning off the instrument or changing the wiring (“**Setting 01**”) on **SET UP** range returns screen 1-A.

• How to switch display screens

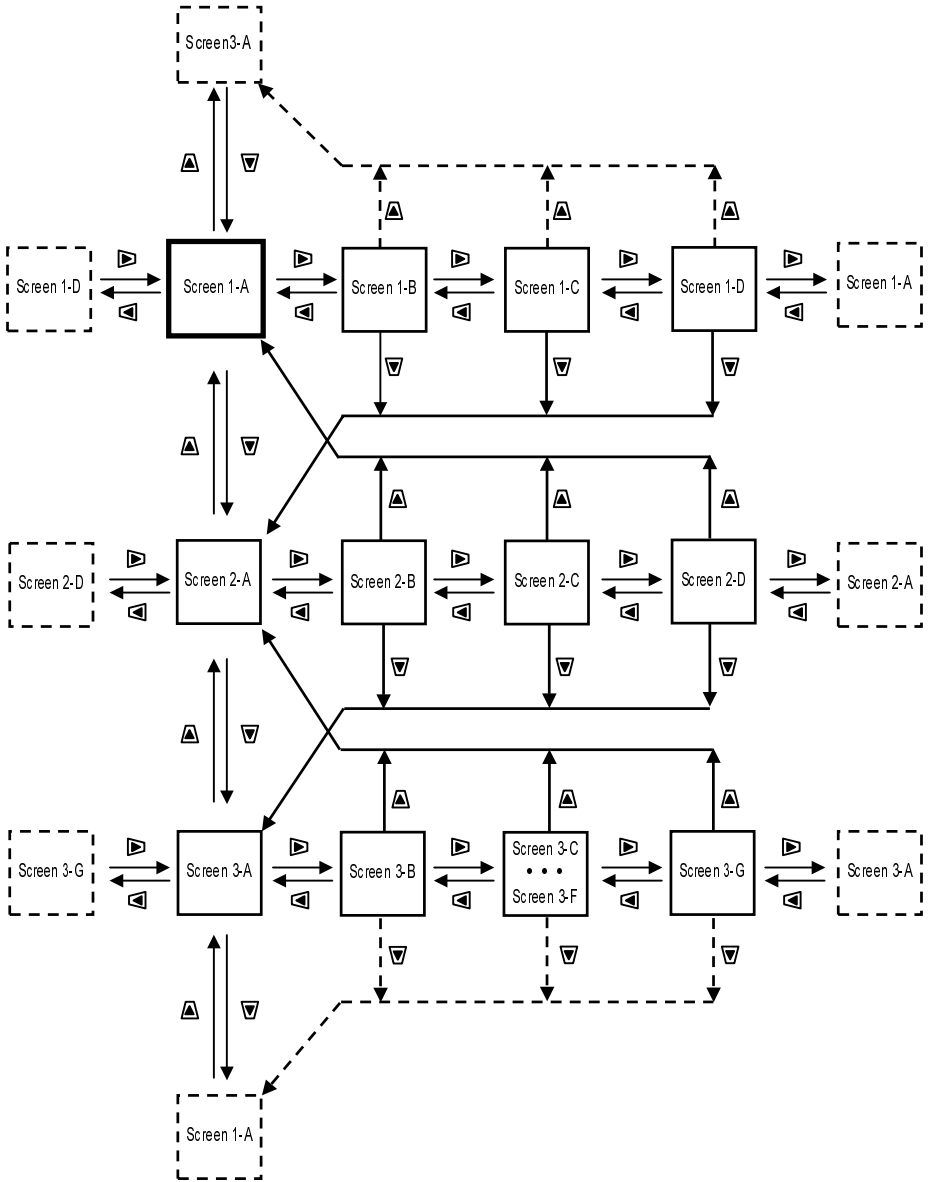

- Display examples

Following are the examples of displays at three-phase 4-wire.

Screen 1-A

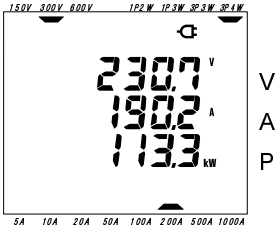

V
A
P

Screen 1-B

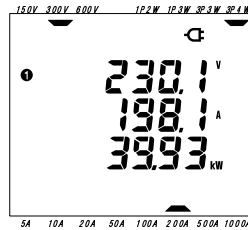

V1
A1
P1

Screen 2-A

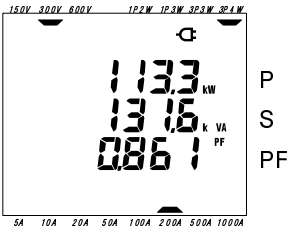

P
S
PF

Screen 2-C

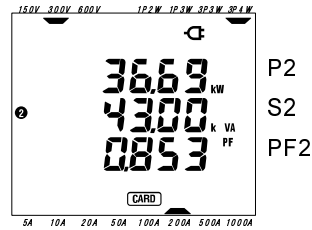

P2
S2
PF2

Screen 3-A

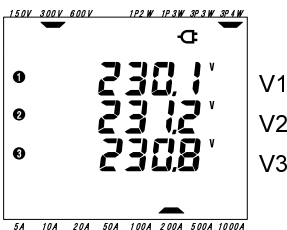

V1
V2
V3

Screen 3-E



S1
S2
S3

6-3 Customizing the display

Following explains how to customize display screens.

The displayed items at each upper/middle/lower row on Screen 1 and 2 can be changed to the desired items.

Screen 3 cannot be customized.

- Customizing example

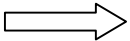
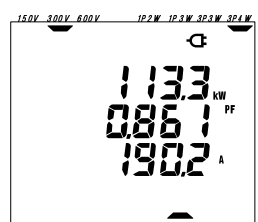
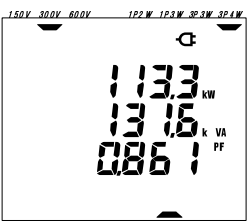
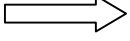
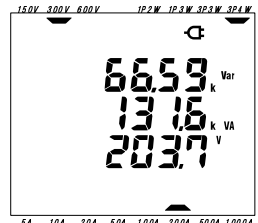
Displayed at:	Before customizing (*)		After customizing
Upper	V : Voltage		P : Active power
Middle	A : Current		PF : Power factor
Lower	P : Active power		A : Current
Screen 1			
Screen 2			
Upper	P : Active power		Q : Reactive power
Middle	S : Apparent power		S : Apparent power
Lower	PF : Power factor		V : Voltage

* Items customized in the past. If it has not been customized or after system reset, start-up screen appears. In this section, start-up screen is used for explanation.

- How to customize
 - * Press the **ENTER** key either on Screen 1 or 2.
 - * It makes the instrument into display customizing mode.
 - Upper displayed items to be customized (initial value: Screen1/ V(Voltage), Screen 2/P(Active power))will blink.
 - * Select the row to be customized with **UP or DOWN cursor** key and the item to be customized with **LEFT or RIGHT cursor** key.
 - * When customizing other rows, select the row and item in same way.
 - * Select any item you want to display it at each row, and press the **ENTER** key.

- Selecting row

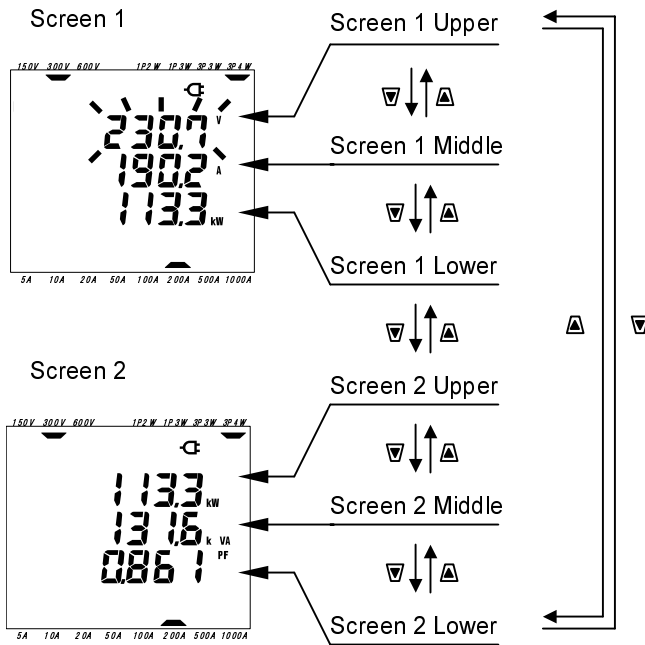

- Selecting items

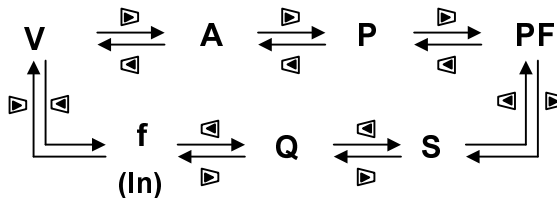

NOTE

- * “f” can be customized only at the upper row, and “In” can be displayed only at the middle row. (when wiring is three-phase 4-wire)
- * Pressing the **ENTER** key on Screen 3 makes the instrument into customize mode for Screen 1-A.
- * Customizing cannot be done during or stand-by mode for integration/ demand measurement.
- * After system reset, start-up screen appears.
- * Pressing the **ESC** key on display customizing mode returns displayed items before the display customizing mode.

6-4 Saving data

Following explains how to save the data of instantaneous value measurement.

Pressing the **SAVE** key on **W** range during a measurement saves all measured data. (Single step operation) (saving the data manually)
 Data to be saved to either below two locations:

- * **CF card** : **Max. 20 files can be saved.**
- * **Internal memory** : **Only 1 file can be saved.**

Data is saved to a CF card automatically when a CF card has been inserted before turning on the instrument. If a CF card has not been inserted, data is saved to internal memory automatically.

6-4-1 How to save

- * Press the **SAVE** key on **W** range during a measurement.
- File is opened.**
- * File number screen appears and the measured data are saved.
 (File number is given automatically.)
- * On the measurement screen, you can recognize that a file is open.

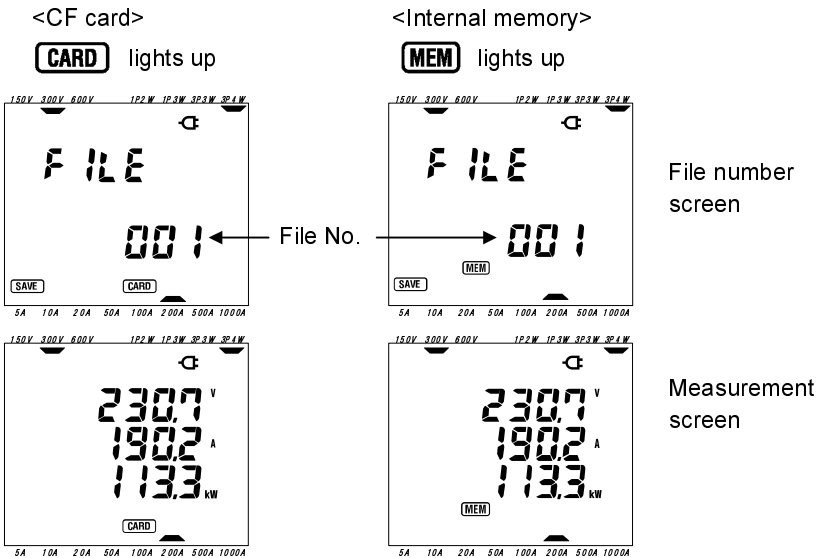

- * Next measured data can be saved when pressing the **SAVE** key while a file is opened. (**SAVE** is displayed for about 1 sec. to show the data is saved)

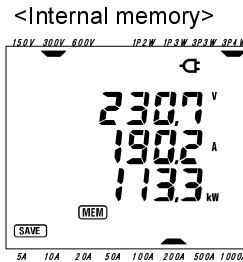
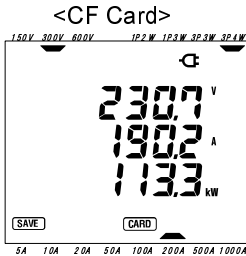

Measurement
screen

- * **File shall be closed after necessary data are saved.** Set the Function switch to any range **other than "OFF" and W**. Then following screen appears. Wait for a second until the selected range is displayed. (in case of CF card is being used, it takes a few seconds.)

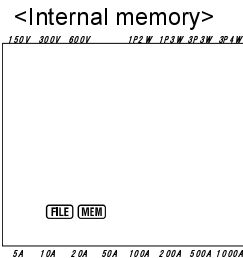
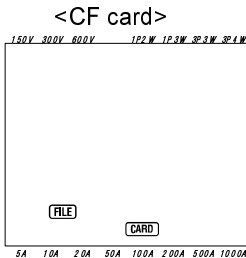

Each time **SAVE** key is pressed; the measured data is saved in one file. To save the data into next file (only when CF card is used), press the **SAVE** key again on **W** range. Then follow the saving procedure to save the data.

NOTE

- * When the Function switch is set to OFF position before closing a file, the opened file is not saved. Be sure to set it to any range other than OFF and **W**, and then close a file.
- * In case that the **SAVE** key is pressed continuously (2 times or more in 1sec.), the measured data may not be saved correctly.
- * In the following case, file number becomes "001":
 - (1) the file number has exceeded 999;
 - (2) after system reset.
- * Data can be saved in the internal memory when a card has been inserted. Please refer to "**Setting 19**" in this manual.

6-4-2 Limitation of saving

In the following case, measured data cannot be saved by pressing the **SAVE** key during a measurement.

<CF card>

* when file quantity has exceeded 20

* when the capacity has exceeded

FULL mark appears and data will not be saved anymore.

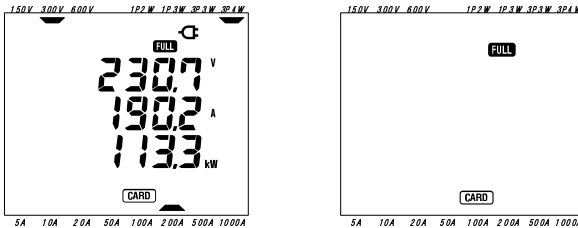

Measured data cannot be saved even if the **SAVE** key is pressed. Confirm that there is no important file, and then delete unnecessary files via PC or delete all data in the CF card according to “**Setting 21**”.

<Internal memory>

* When previous saved data exist

(**MEM** mark appears to indicate there is a file in the internal memory.)

* When the capacity of internal memory has exceeded.

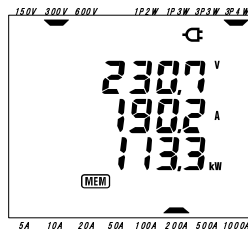

Pressing the **SAVE** key displays the screen to confirm whether you delete the file saved to internal memory or not.

To delete the file;

* The message "dAtA not .dEL" (not delete) is displayed on the screen.

Press the **Cursor** key and select "dAtA.dEL" (delete).

* Then press the **ENTER** key.

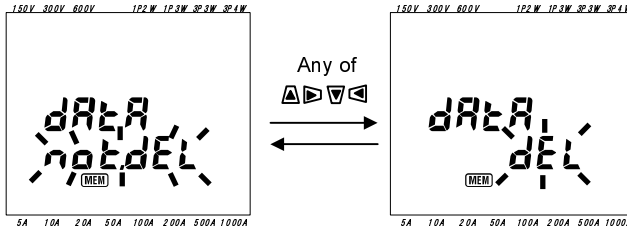

NOTE

* For further details about the capacities of CF card and internal memory, please refer to "Section 9: CF card/ Internal memory" in this manual.

6-4-3 Save data

- Saving items (depends on each wiring)

Following items are saved.

Measurement/ calculation items		
Voltage (RMS)	V : Average voltage of each phase	V _i : Voltage of each phase
Current (RMS)	A : Average current of each phase	A _i : Current of each phase
Active power	P : Total active power	P _i : Active power of each phase
Reactive power	Q : Total reactive power	Q _i : Reactive power of each phase
Apparent power	S : Total apparent power	S _i : Apparent power of each phase
Power factor	PF : Power factor of whole system	PF _i : Power factor of each phase
Frequency	f : Frequency at V1	
Neutral current	In : Current on a neutral line	

*i = 1, 2, 3

• File format and name

Measured data are saved in a CSV format, and the file name is given automatically.

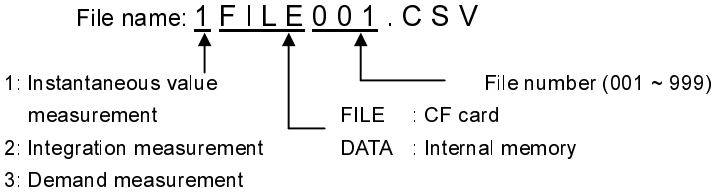

• Example of measured data

Following is an example when opening a file saved in a CF Card or internal memory, when opened via a spreadsheet application (CSV format).

Wiring:	3P4W	←	Wiring	"Setting 01"
Volt Range:	300V	←	Voltage range	"Setting 02"
Current Range:	200A	←	Current range	"Setting 03"
Sensor Type:	500A	←	Clamp sensor	"Setting 04"
VT ratio:	1	←	VT ratio	"Setting 05"
CT ratio:	1	←	CT ratio	"Setting 06"

DATE	TIME	V1	V2	V3	A1	A2	A3	P	P1	P2	P3
* 1	2004/3/21	15:50:35									
* 2	2004/3/21	16:51:21									
* 3	⋮	⋮	⋮	⋮	⋮	⋮	⋮	⋮	⋮	⋮	⋮

PF	PF1	PF2	PF3	S	S1	S2	S3	Q	Q1	Q2	Q3	f	In

- *1: Measured data is saved when **SAVE** key is pressed first time (when a file is opened).
- *2: Measured data is saved when **SAVE** key is pressed again while a file is opened.
- *3: Measured data is saved whenever **SAVE** key is pressed while a file is opened.

Data will be displayed in index format. (e.g. when V1 is 100.1V, "1.001E+2").

6-5 Digit / Over-range indication

Following explains about the digit and decimal position on each measurement/ calculation item displayed on measurement screen.

6-5-1 Digits

Digit on each measurement item is decided automatically based on each setting of:

Voltage range ("**Setting 02**"), Current range ("**Setting03**"), VT ratio ("**Setting 05**") and CT ratio ("**Setting 06**"). (Fixed range)

- **Voltage V**: V(average of each phase), V1/V2/V3 (each phase), max 4 digits
150/300/600V range

Voltage range x VT ratio x 120%	Digit and decimal position
180 ~ 999.9 V	999.9 V
1k ~ 9.999 kV	9.999 kV
10k ~ 99.99 kV	99.99 kV
100k ~ 999.9 kV	999.9 kV
1M ~ 7.2 MV	7.200 MV

When the value; Voltage range x VT ratio x 120% exceeds 9999, the digit is moved one place to the right.

- **Current A**: A(average of each phase), A1/A2/A3 (each phase), max 4 digits
50A Clamp sensor : 5 / 10 / 20 / 50A range
100AClamp sensor : 10 / 20 / 50 / 100A range
200AClamp sensor : 20 / 50 / 100 / 200A range
500AClamp sensor : 50 / 100 / 200 / 500A range
1000AClamp sensor : 100 / 200 / 500 / 1000A range
3000AClamp sensor : 1000 / 3000A range

Current range x CT ratio x 120%	Digit and decimal position
6 ~ 9.999 A	9.999 A
10 ~ 99.99 A	99.99 A
100 ~ 999.9 A	999.9 A
1k ~ 9.999 kA	9.999 kA
10k ~ 99.99 kA	99.99 kA
100k ~ 999.9 kA	999.9 kA
1M ~ 9.999 MA	9.999 MA
12 MA	12.00 MA

When the value; Current range x CT ratio x 120% exceeds 9999, the digit is moved one place to the right.

- **Active power P/ Reactive power Q/ Apparent power S**

: P1/P2/P3, Q1/Q2/Q3, S1/S2/S3 (each phase), max 4 digits

: P, Q, S (total), max 5 digits

Power (*) x VT ratio x CT ratio x 120%	Digit and decimal position
900 ~ 999.9 W/Var/VA	999.9 W/Var/VA
1k ~ 9.999k W/Var/VA	9.999 k W/Var/VA
10k ~ 99.99k W/Var/VA	99.99 k W/Var/VA
100k ~ 999.9k W/Var/VA	999.9 k W/Var/VA
1M ~ 9.999M W/Var/VA	9.999 M W/Var/VA
10M ~ 99.99M W/Var/VA	99.99 M W/Var/VA
100M ~ 999.9M W/Var/VA	999.9 M W/Var/VA
1G ~ 9.999G W/Var/VA	9.999 G W/Var/VA
10G ~ 99.99G W/Var/VA	99.99 G W/Var/VA
100G ~ 999.9G W/Var/VA	999.9 G W/Var/VA
1000G ~ 9999 G W/Var/VA	9999 G W/Var/VA

* Following is a list of power corresponding to each voltage and current range.

Voltage range	Current range							
	5.000A	10.00A	20.00A	50.00A	100.0A	200.0A	500.0A	1000A
150.0V	750.0	1.500k	3.000k	7.500k	15.00k	30.00k	75.00k	150.0k
300.0V	1.500k	3.000k	6.000k	15.00k	30.00k	60.00k	150.0k	300.0k
600.0V	3.000k	6.000k	12.00k	30.00k	60.00k	120.0k	300.0k	600.0k

Above listed power applies to single-phase 2-wire(1ch) and the each phase of other wirings. Total power of the phases of single-phase 2-wire(2ch)/ single-phase 3-wire/ three-phase 3-wire will be twice that of the above each value. Total power of the phases of single-phase 2-wire(3ch)/ three-phase 4-wire will be three times that of the above each value.

- **Power factor PF:** PF (whole system), PF1/PF2/PF3 (each phase), 4 digits

Display range
-1.000 ~ 1.000 PF

- **Frequency f:** 3 digits

Display range
40.0 ~ 70.0 Hz

- **Neutral current In** (only at three-phase 4-wire): max 5 digits

Decimal point and the unit are same to current A.

6-5-2 Over-range indication/ Bar indication

- Be sure to confirm following points.

WARNING

- When over-range indication appears on the max range of this instrument, it means the input exceeds the max allowable input of the instrument.
Never apply the input, which exceeds the max allowable input of the instrument.
- In case that you measure the value exceeding the max allowable input, be sure to use VT and CT. Please refer to “5-3 VT/ CT” and be sure to keep the instructions contained in this manual.

CAUTION

- Calculation continues in the instrument, when over-range indication appears on the screen, but the accuracy may be out of specification.

- Over-range indication

Over-range indication appears when each item (Voltage V, Current A, Active power P, Reactive power Q, Apparent power S) exceeds following condition.

* Voltage V (V): Voltage range x VT ratio x 120%

(e.g.: when voltage range is 300V and VT ratio is 1: 360.0V)

* Current A (A): Current range x CT ratio x 120%

(e.g.: when current range is 200A and CT ratio is 2: 480.0A)

* Active power P (W)/ Reactive power Q (Var)/ Apparent power S (VA)



: Power x VT ratio x CT ratio x 120%

(e.g.: when power is 60kW, VT ratio is 1 and CT ratio is 2: 144.0kW)

<  indication >

When each item meets above condition, segment becomes “  ”.

<  mark >

When “  ” appears on any of V1, V2 and V3, this mark is displayed at the upper left on the LCD. In this case,  mark appears on all measurement screens on  range.

< **AOL** mark >

When “**OL**” appears on any of A1, A2 and A3, this mark appears at the upper left on the LCD. In this case, **AOL** mark appears on all measurement screens on **W** range.

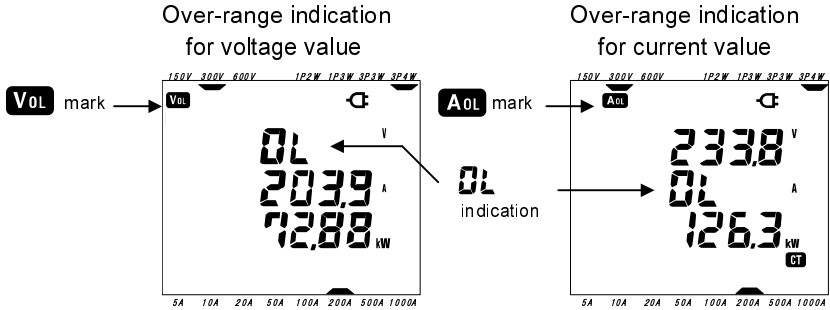

• Bar indication

This instrument performs measurement/ calculation based on the voltage and frequency on V1. When the input signal to V1 is 5% or less of the range or the frequency is other than 40 ~ 70Hz, each item except for current value becomes Bar indication like “- - - -”. In this case, measurement and calculation cannot be made.

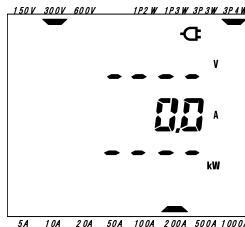

NOTE

* **V0L** or **AOL** mark is sometimes displayed during integration/ demand measurement on all measurement screen on each range.

7. Integration value measurement

Following explains about integration value measurement.

Set the Function switch to **Wh** range.

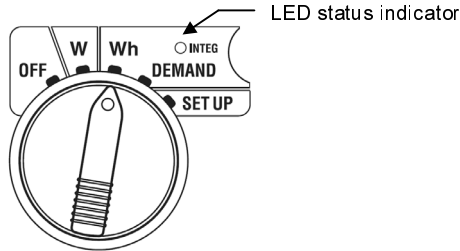

When Function switch is set to below position on measurement/stand-by mode;

- W** range : Confirm instantaneous value.
(see “Section 6: Instantaneous value measurement”)
- DEMAND** range : No use
- SET UP** range : Confirm the setting.
(see “Section 4: Settings”)

- Indications

Measurement/Calculation item		Unit
Active electric energy (consumption)	WP : Total active electric energy	Wh
	WP1/WP2/WP3 : Active electric energy of each phase	
Apparent electric energy (consumption)	WS : Total apparent electric energy	VAh
	WS1/WS2/WS3 : Apparent electric energy of each phase	
Elapsed time of integration	TIME : Hour; Min.; Sec. Hour; Min. Hour	-

NOTE

- * Above measurement/calculation items vary depending on each wiring.
- * When V1 is out of measuring range, each measurement/calculation may not be performed.
- * Only the consumed electric energy is displayed on the screen. Regenerative energy will be saved . Please refer to “7-5-3 Save data” in this manual.
- * Displayed time changes with the elapsed time of integration.

- Before making a measurement

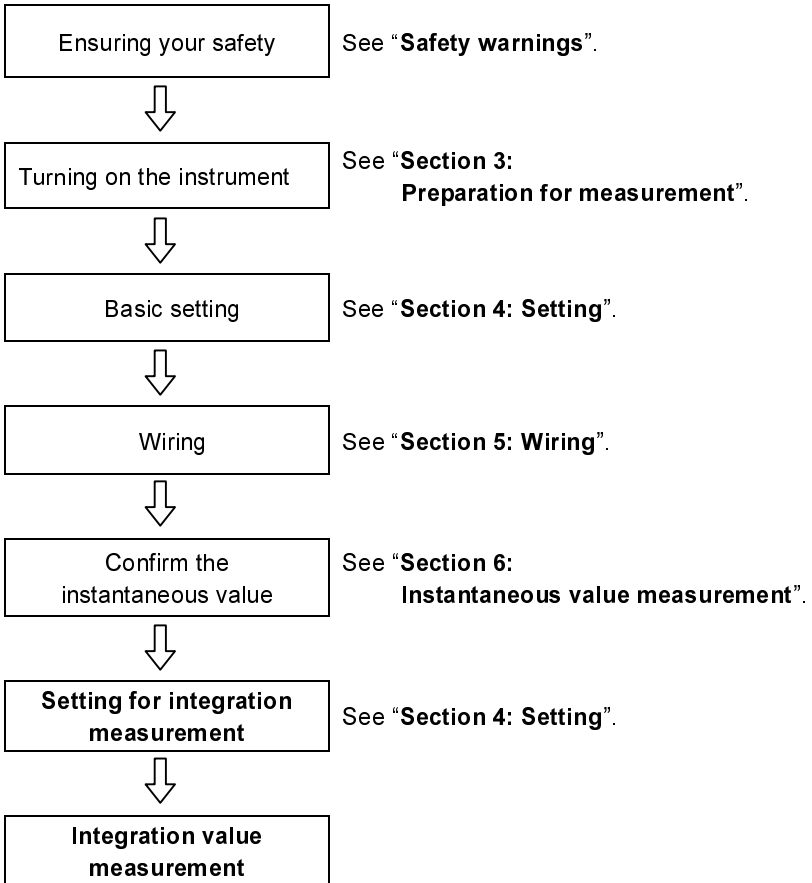

- Settings only for integration measurement

Basic setting and following settings are required for integration measurement.









“**Setting 09**” Integration interval

“**Setting 10**” Integration start date & time (measurement starts at set date & time)

“**Setting 11**” Integration stop date & time (measurement stops at set date & time)

“**Setting 12**” Reset of integration value

- Keys

Key		Description
	START/STOP key	Pressing this key starts/stops integration measurement manually or automatically.
	BACKLIGHT key	Switches on/off the backlight of the LCD.
	UP cursor key DOWN cursor key	Switches the display contents.
	LEFT cursor key RIGHT cursor key	Switches the display contents.
	ENTER key	Reset the integration value. Enters the decision to delete a file in the internal memory.
	ESC key	Reset the integration value.
	DATA HOLD key	Holds the indication value on the LCD.
		Pressing this key for 2 sec. or more disables all key operations to prevent operation mistake during a measurement.
	SAVE key	No use

NOTE

* Data hold function is disabled while the instrument is in stand-by mode for integration measurement.

7-1 How to start measurement

Following explains how to start integration measurement.

There are two methods to start measurement.

(1) Manual operation

Pressing **START/STOP** key on **Wh** range 2 sec. or more starts measurement.

(2) Automatic operation (specifying the date and time)

Set the start date and time on **SET UP** range (“**Setting 10**”), and then Press **START/STOP** key on **Wh** range. The instrument becomes stand-by mode, and the measurement starts at the set date and time.

- To start measurement manually

- * Pressing the **START/STOP** key on **Wh** range 2 sec. or more.

- * File number screen is displayed for about 2 sec. (file is opened), and then it switches to measurement screen. After that, measurement starts.

At this time, LED status indicator lights up. In addition, **INTEG** and **CARD** (*) marks appear on the measurement screen.

- * This is when data are saved to the CF card. When data are saved to the internal memory, **MEM** mark appears. (See “**Setting19**”).

File number screen
(displayed for about 2 sec.)



Measurement screen

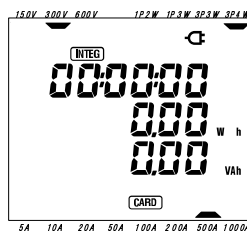

LED status indicator lights up

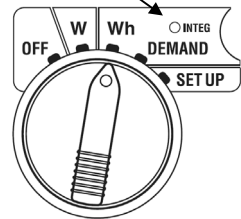

- To start measurement automatically at the set date and time
Set the start date and time on **SET UP** range.

- * Set the start date and time on **SET UP** range. (“Setting 10”)
- * Set the Function switch to **Wh** range, and press the **START/STOP** key.
- * File number screen is displayed for about 2 sec. (file is opened), and then it switches to measurement screen. The instrument becomes stand-by mode for measurement. LED status indicator and **INTEG** mark blinks while the instrument is on stand-by mode.

File number screen
(displayed for about 2 sec.)

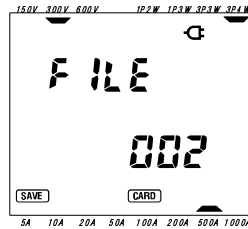

Measurement screen

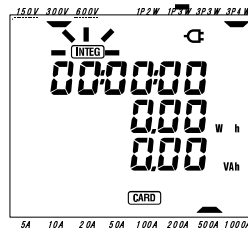

LED status indicator
blinks

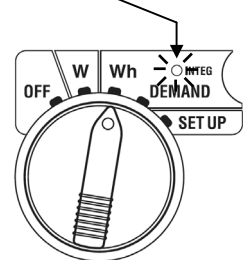

- * When data are saved to the CF card, **CARD** mark; when data are saved to the internal memory, **MEM** mark appears on the File number screen and measurement screen. (See “Setting19”.)
- * Measurement starts at the set date and time, and the **INTEG** mark and the LED status indicator are being lit up. (from blinking to lighting up)

NOTE

- * **INTEG** mark, which shows measurement/ stand-by mode, is also displayed on **W** range and **DEMAND** range.

NOTE

- * Set the start date and time well in advance to the present time.
Start time may have passed while making other settings.
- * When the start date and time are set to earlier than the present time, measurement starts immediately by pressing the **START/STOP** key.
- * When the start date and time are set to later than the stop date and time, measurement stops right after the start of measurement.
- * Measurement starts by manual operation when the start/ stop date and time have been set. (Press the **START/STOP** key 2 sec. or more.)
Manually starting measurement makes the start/ stop date and time settings ineffective.
- * Pressing the **START/STOP** key 2 sec. or more releases the stand-by mode.
Then **INTEG**, **CARD** (or **MEM**) marks disappear and the LED status indicator goes off.

7-2 How to stop measurement

Following explains how to stop the measurement.

There are two methods to stop measurement.

(1) Manual operation

Pressing **START/STOP** key on **Wh** range 2 sec. or more stops measurement.

This action also stops the measurement started at the set date and time.

(2) Automatic operation (specifying the date and time)

Set the stop date and time on **SET UP** range ("Setting 11").

- To stop measurement manually

- * Pressing **START/STOP** key on **Wh** range 2 sec. or more stops the measurement. When it stops, **INTEG**, **CARD** (in case data to be saved to CF card) marks disappear and the LED status indicator goes off.

- To stop measurement automatically at the set date and time

- *Set the stop date and time on **SET UP** range. ("Setting 11")

This method is available only when the measurement is started at the set date and time. When the set date and time has been reached, **INTEG**, **CARD** (in case data to be saved to CF card) marks disappear and LED status indicator goes off. Then measurement stops.

When measurement stops manually or automatically, **FILE** mark appears. Close the file opened at the measurement start time.

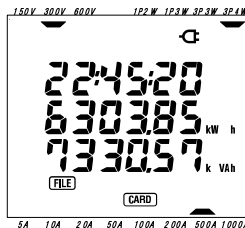

NOTE

- * When data is to be saved to the internal memory, **MEM** mark kept displayed on the LCD. (indicating that a file exists in the internal memory.)

NOTE

- * Measurement also stops when turning off the instrument (set the Function switch to OFF position) but the measured data from the beginning of the measurement may be lost. Measurement must be stopped manually (**START/STOP** key) or by specifying the stop date and time.
- * Manually starting measurement makes the stop date and time setting ineffective. You need to stop measurement manually in this case.
- * Measurement can be made when the period from the beginning to the end of measurement is shorter than the integration interval ("**Setting 09**"). But the measured data are not saved after measurement.
- * If the start date and time are set to later than the stop date and time, measurement stops right after the start of measurement.
- * Pressing the **START/STOP** key 2 sec. or more releases the stand-by mode. Then **INTEG**, **CARD** (or **MEM**) marks disappear and LED status indicator goes off.

7-3 Resetting the integration value

There are three methods to reset (delete) the indication of previous integration value and the elapsed time of integration.

- * Press **ESC** key on **Wh** range 2 sec. or more.
- * Reset the integration value at “**Setting 12**”.
- * System reset

Following explains how to reset the integration value with the **ESC** key.

- * Press **ESC** key on **Wh** range 2 sec. or more.
- * Then a message “oFF” (not reset) blinks. Select “on” (reset) with **Cursor** key, and press the **ENTER** key.
- * The previous integration value will be reset, and the elapsed time of integration becomes 0 as well.

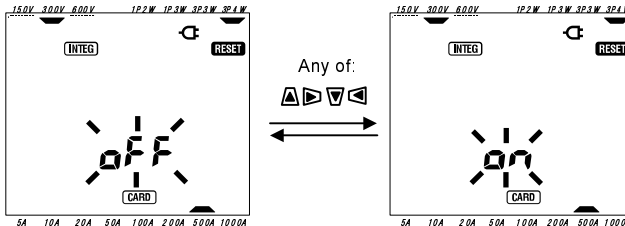

When you don't reset them, press the **ENTER** or **ESC** key while “oFF” is blinking.

NOTE

- * Integration value cannot be reset during a measurement or while the instrument is on stand-by mode.

7-4 Switching displays

Following explains how to switch displays.

Displays can be switched as follows with **Cursor** keys. Contents displayed on the LCD vary depending on each wiring. Every calculation of measurement item is actually being performed, although it is not displayed on the display screen.

- How to switch the display (Three-phase 4-wire)

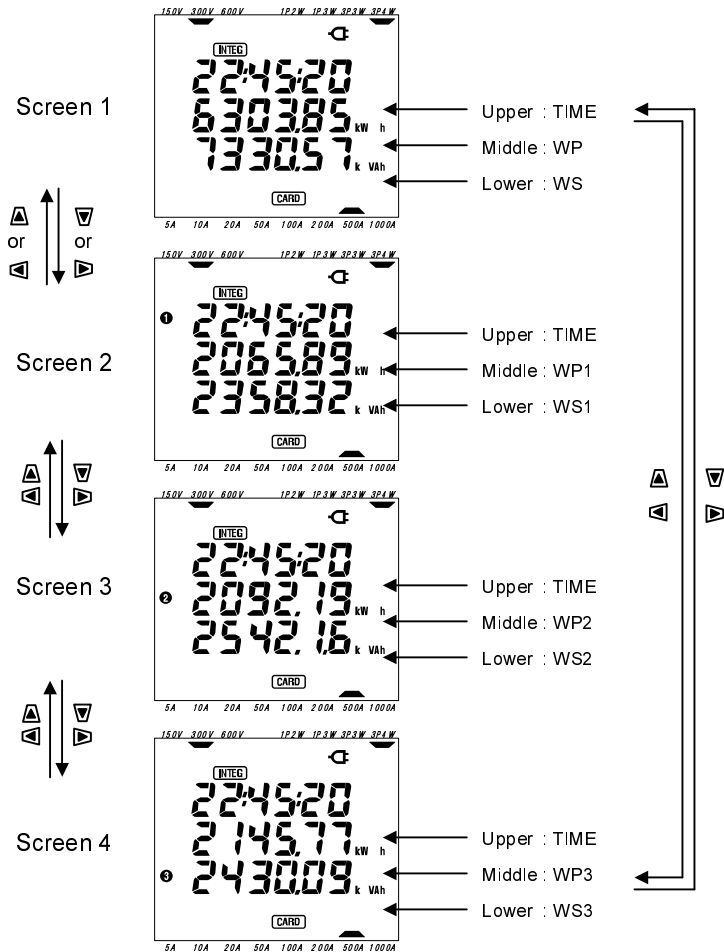

- Indications on each wiring

Following messages are displayed on the LCD at each wiring.

Wiring ("Setting 01")	Displayed at	Displayed contents			
		Screen1	Screen2	Screen3	Screen4
1P2W (1ch)	Upper	TIME			
	Middle	WP	-	-	-
	Lower	WS			
1P2W (2ch) 1P3W 3P3W	Upper	TIME	TIME	TIME	
	Middle	WP	WP1	WP2	-
	Lower	WS	WS1	WS2	
1P2W (3ch) 3P4W	Upper	TIME	TIME	TIME	TIME
	Middle	WP	WP1	WP2	WP3
	Lower	WS	WS1	WS2	WS3

Signs listed in above table:

- TIME : Elapsed time of integration
 WP : Total active electric energy
 WP1/WP2/WP3 : Active electric energy of each phase
 WS : Total apparent electric energy
 WS1/WS2/WS3 : Apparent electric energy of each phase

7-5 Saving data

Following explains how to save integration measurement data.

When integration or demand measurement starts, the measured data will be saved automatically.

There are two locations for saving data.

* **CF card** : **Max. 20 files can be saved.**

* **Internal memory** : **Only 1 file can be saved**

Data is saved to a CF card automatically when a CF card has been inserted before turning on the instrument. If a CF card has not been inserted, data is saved to internal memory automatically.

7-5-1 How to save

* Start integration measurement manually or automatically. (open a file)

* Data are saved at the integration interval (“**Setting 09**”).

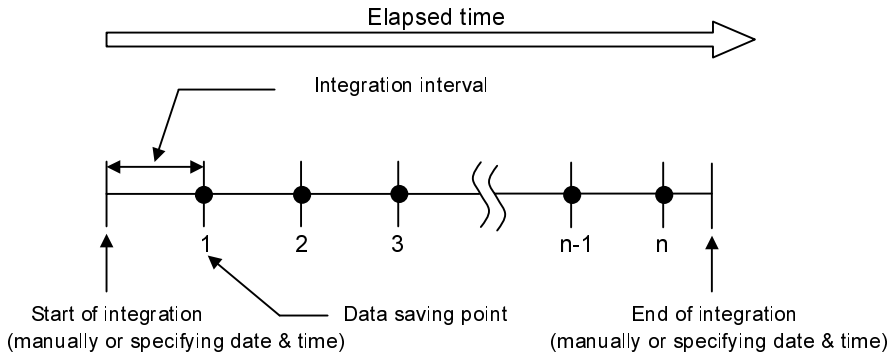

* Stop the integration measurement manually or specifying the date and time. (close a file)

* Measured data at the data saving point are saved to one file.

NOTE

* Measured data can be saved to a file when measurement stops (close a file). Never set the Function switch to OFF position during a measurement. If the switch is set to OFF position, measured data from the beginning of measurement may be lost.

* In the following case, file number becomes “001”:

(1) the file number has exceeded 999;

(2) after system reset

* Data can be saved to the internal memory when a card has been inserted.

Please refer to “**Setting 19**” in this manual.

7-5-2 Limitation of saving

- Limitation of saving (before measurement)

In following cases, measurement cannot be started neither by manually or automatically by pressing the **START/STOP** key.

< In case data to be saved to CF card >

- * When 20 files has been saved to the CF card; **FULL** mark appears and data will not be saved.

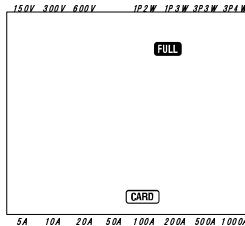

Unnecessary files shall be deleted via your PC, or all files saved to CF card shall be deleted at “**Setting 21**”.

< In case the data to be saved to internal memory >

When previous saved data exist

- * **MEM** mark is displayed on the LCD to indicate that there is a file in the internal memory.

Pressing the **START/STOP** key displays the screen to confirm whether you delete the file, saved in the internal memory or not.

To delete the file;

- * The message “**dAtA not .dEL**” (not delete) is displayed on the screen.

Press the **Cursor** key and select “**dAtA.dEL**” (delete).

- * Then press the **ENTER** key.

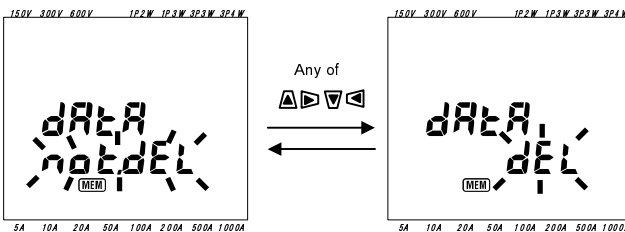

In case of manual operation, measurement starts right after deleting the data in the internal memory. When start date and time has been set, the instrument becomes stand-by mode.

- Limitation of saving (during a measurement)

When capacity of CF card or internal memory has been exceeded during a measurement; measurement continues but **FULL** mark appears on the measurement screen and data will not be saved anymore.

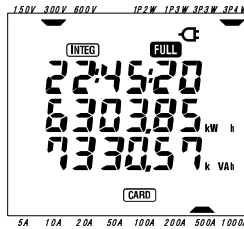

Press the **START/STOP** key 2 sec. or more and stop the measurement once. Please refer to preceding page and delete the unnecessary file.

NOTE

- * Be sure to stop measurement by pressing the **START/STOP** key. When the Function switch is set to OFF before stopping a measurement, the measured data may be lost.
- * For further details about the capacity of CF card and internal memory, please refer to "**Section 9: CF card/ Internal memory**" in this manual.

7-5-3 Save data

- Saving items (depend on each wiring)

Following items are saved to a CF card or internal memory.

Measurement/Calculation item			
Voltage (RMS)	V	: Average voltage of each phase	V_i : Voltage of each phase
	V max	: Max. value of V	V_i max : Each max. value of V_i
	V avg	: Average value of V	V_i avg : Each average value of V_i
Current (RMS)	A	: Average current of each phase	A_i : Current of each phase
	A max	: Max. value of A	A_i max : Each max. value of A_i
	A avg	: Average value of A	A_i avg : Each average value of A_i
Active power	P	: Total active power	P_i : Active power of each phase
	P max	: Max. value of P	P_i max : Each max. value of P_i
	P avg	: Average value of P	P_i avg : Each average value of P_i
Reactive power	Q	: Total reactive power	Q_i : Reactive power of each phase
	Q max	: Max. value of Q	Q_i max : Each max. value of Q_i
	Q avg	: Average value of Q	Q_i avg : Each average value of Q_i
Apparent power	S	: Total apparent power	S_i : Apparent power of each phase
	S max	: Max. value of S	S_i max : Each max. value of S_i
	S avg	: Average value of S	S_i avg : Each average value of S_i
Power factor	PF	: Power factor of whole system	PF_i : Power factor of each phase
	PF max	: Max. value of PF	PF_i max : Each max. value of PF_i
	PF avg	: Average value of PF	PF_i avg : Each average value of PF_i
Frequency	f	: Frequency of V1	
	f max	: Max. value of f	
	f avg	: Average value of f	
Neutral current	I_n	: Current on neutral line	
	I_n max	: Max. value of I_n	
	I_n avg	: Average value of I_n	
Active electric energy (consumption)	+WP	: Total active electric energy(consumption)	
	+WP $_i$: Active electric energy of each phase (consumption)	
Active electric energy (regenerating)	-WP	: Total active electric energy (regenerating)	
	-WP $_i$: Active electric energy of each phase (regenerating)	
Active electric energy (overall)	#WP	: Total active electric energy(overall)	
	#WP $_i$: Active electric energy of each phase(overall)	
Apparent electric energy (consumption)	+WS	: Total apparent electric energy (consumption)	
	+WS $_i$: Apparent electric energy of each phase (consumption)	
Apparent electric energy (regenerating)	-WS	: Total apparent electric energy (regenerating)	
	-WS $_i$: Apparent electric energy of each phase (regenerating)	
Apparent electric energy (overall)	#WS	: Total apparent electric energy(overall)	
	#WS $_i$: Apparent electric energy of each phase(overall)	
Reactive electric energy (consumption)	+WQ	: Total reactive electric energy (consumption)	
	+WQ $_i$: Reactive electric energy of each phase (consumption)	

* $i = 1, 2, 3$

* max, avg mean max value and average value during an interval.

• File format and name

Measured data are saved in a CSV format, and the file name is given automatically.

File name: 2 FILE 001 . CSV

- 1: Instantaneous value measurement
 - 2: Integration measurement
 - 3: Demand measurement
- FILE : CF card
 DATA : Internal memory

• Example of measured data

Wiring:	3P4W	← Wiring	"Setting 01"
Volt Range:	300V	← Voltage range	"Setting 02"
Current Range:	500A	← Current range	"Setting 03"
Sensor Type:	500A	← Clamp sensor	"Setting 04"
VT ratio:	1	← VT ratio	"Setting 05"
CT ratio:	1	← CT ratio	"Setting 06"
Interval	30min	← Integration interval	"Setting 09"
START	2004/03/22_08:30:00	← Integration start date and time	

DATE	TIME	ELAPSED TIME	V1	V2	V3	Q3	f	In
1	2004/03/22	09:00:00	00000:30:00					
2	2004/03/22	09:30:00	00001:00:00					
n								

V1 max	V2 max	V3 max	Q3 max	F max	In max	V1 avg	V2 avg	V3 avg	Q3 avg	F avg	In avg

+ WP	+ WP1	+ WP2	- WP3	# WP	# WP1	# WP2	# WP3	+ WS	# WS2	# WS3	+ WQ

Data will be displayed in index format. (e.g. 38672.1kWh, "3.86721E+7").

7-6 Digits/ Over-range indication

Following explains about digits to be displayed and over-range indication.

- Digits

* **Active electric energy WP, Apparent electric energy WS** (auto-range)

: WP1/WP2/WP3, WS1/WS2/WS3 (each phase), max 6 digits

: WP, WS (total), max 6 digits

Range will be automatically selected according to the corresponding measured value right after the start of measurement. When the integration value exceeds 999999, a digit is moved to one place to the right.

Unit: Wh/ VAh	
0.00	~ 9999.99
10000.0	~ 99999.9
100000	~ 999999
1000.00 k	~ 9999.99 k
10000.0 k	~ 99999.9 k
100000 k	~ 999999 k
1000.00 M	~ 9999.99 M
10000.0 M	~ 99999.9 M
100000 M	~ 999999 M
1000.00 G	~ 9999.99 G
10000.0 G	~ 99999.9 G
100000 G	~ 999999 G

When a value exceeds 999999G or more, display screen returns to 0.00. But the saved data will be kept.

- * **Elapsed time TIME**

It changes with time as follows.

Elapsed time		
00:00:00	~ 99:59:59	hour: minute: second
100:00	~ 9999:59	hour: minute
10000	~ 999999	hour

- Over-range indication/ others

* When the input voltage and the current exceeds the max display counts, **V_{OL}** or **A_{OL}** mark is displayed on the LCD. In this case, accurate measurement might not be made.

* On **W** range, when P (active power) is indicated by bars " - - - ", the increase on electric energy is regarded as 0.

Please refer to "**6-5-2 Over-range indication/ Bar indication**" in this manual.

8. Demand value measurement

Following explains about demand value measurement.

Set the Function switch to **DEMAND** range.

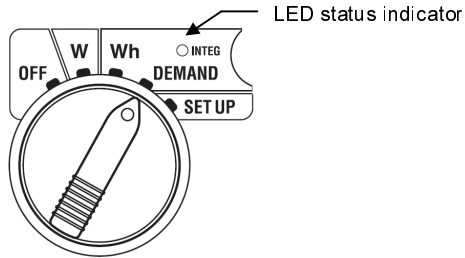

When Function switch is set to below position on measurement/stand-by mode;

- W** range : Confirm the instantaneous value.
(see “**Section 6: Instantaneous value measurement**”)
- Wh** range : Confirm the integration value.
(see “**Section 7: Integration value measurement**”)
- SET UP** range : Confirm the setting
(see “**Section 4: Settings**”)

• Indications

Measurement/Calculation items	Unit
Target value	W
Predicted value	W
Present value	W
Load factor	%
Remaining time(*)	-
Max. demand value	W
Date and time when max. demand value measured	-

* Demand interval is counted down.

- Before making a measurement

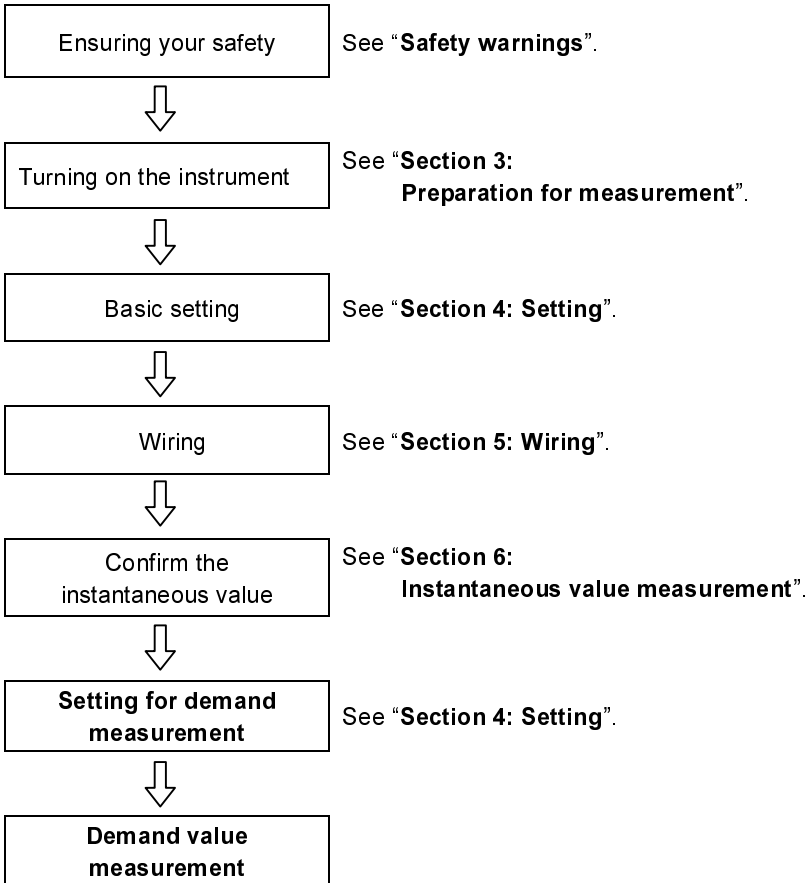

- Settings only for demand measurement

Basic setting and following settings are required for demand measurement.

“**Setting 13**” Demand interval

“**Setting 14**” Demand start date & time (measurement starts at setting date & time)









“**Setting 15**” Demand stop date & time (measurement stops at setting date & time)

“**Setting 16**” Demand target value

“**Setting 17**” Demand inspection cycle

“**Setting 18**” Reset of demand value

- Keys

Key		Description
	START/STOP key	Pressing this key starts/stops demand measurement manually or automatically.
	BACKLIGHT key	Switches on/off the backlight of the LCD.
	UP cursor key DOWN cursor key	Switches the display contents.
	LEFT cursor key RIGHT cursor key	Switches the display contents.
	ENTER key	Reset the demand value. Enters the decision to delete a file in the internal memory.
	ESC key	Reset the demand value.
	DATA HOLD key	Holds the indicated value on the LCD.
		Pressing this key for 2 sec. or more disables all key operations to prevent operation mistake during a measurement.
	SAVE key	No use

NOTE

- * Data hold function is disabled while the instrument is in stand-by mode for demand measurement.

8-1 Demand measurement

Following describes an example of demand measurement, which is best suited for electric power control.

- Reducing average power during specific interval

Divide the average power consumption at any interval (where it is specified as 30 min.) as follows. Then average power consumption of a load at Interval 1 is assumed to be 500kW and Interval 2 is assumed to be 600kW.

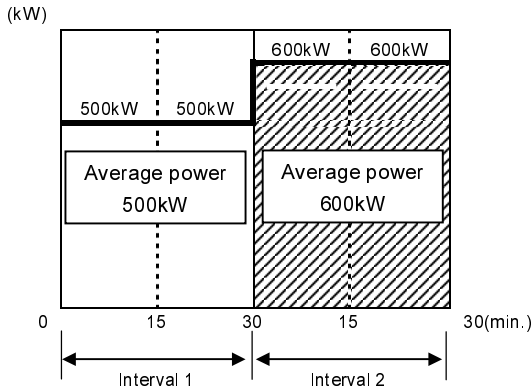

In case that a power of 600kW has been consumed for first 15 min. in Interval 2; average power consumption in Interval 2 can be reduced to 500kW (to the same extent of Interval 1) by reducing the power consumption of last 15 min. to 400kW.

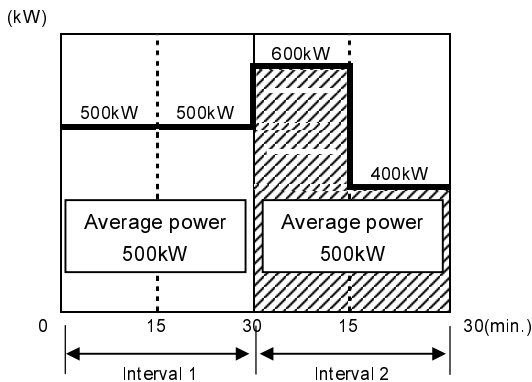

When a power of 1000kW has been consumed for first 15 min. and 0kW for last 15 min., average power consumption is 500kW.

- Demand measurement with this instrument

This instrument can measure loads, and display the predicted value and present value of average power during the interval as time goes by.

Buzzer sounds and backlight blinks when a predicted value exceeds a target value in the pre-set inspection cycle during the interval.

The value displayed after an interval (in this case, 30 min.) has been reached is the average power (**Demand value**) in this interval.

<Relationship among: Target value, Predicted value, Present value, interval and inspection cycle>

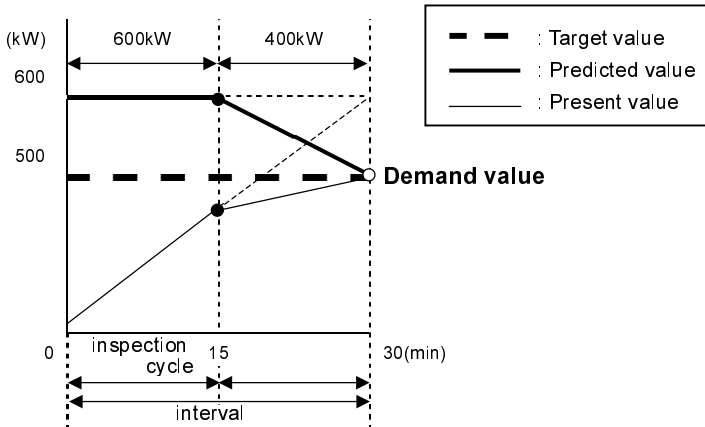

* In this case, demand value for 30 min. is 500kW.

The demand values calculated by intervals are suitable for power control by day, week and month.

NOTE

* A demand meter, which is installed by a power company, and our instrument may not match completely due to time-lag.

- Settings required for Demand measurement

Interval : “**Setting 13**” Demand interval
 Target value : “**Setting 16**” Demand target value
 Inspection cycle : “**Setting 17**” Demand inspection cycle
 Buzzer : “**Setting 07**” Buzzer

To start/stop measurement at set date and time, following settings are also required. Please refer to “**8-3 How to start measurement**” and “**8-4 How to stop measurement**” in this manual.

* Measurement start: “**Setting 14**”: Demand start date and time

* Measurement stop: “**Setting 15**”: Demand stop date and time

- Saving Demand values

When one demand measurement (demand interval) ends, demand values are saved to a CF card or internal memory.

Please refer to “**8-6 Saving data**” in this manual. After saving data, next demand measurement starts.

The max. demand value is displayed on the LCD with the date and time.

Following is an example of the saving status of demand value measurement when; demand interval is 30 min and the period from the beginning to the end of measurement is about 3 hours.

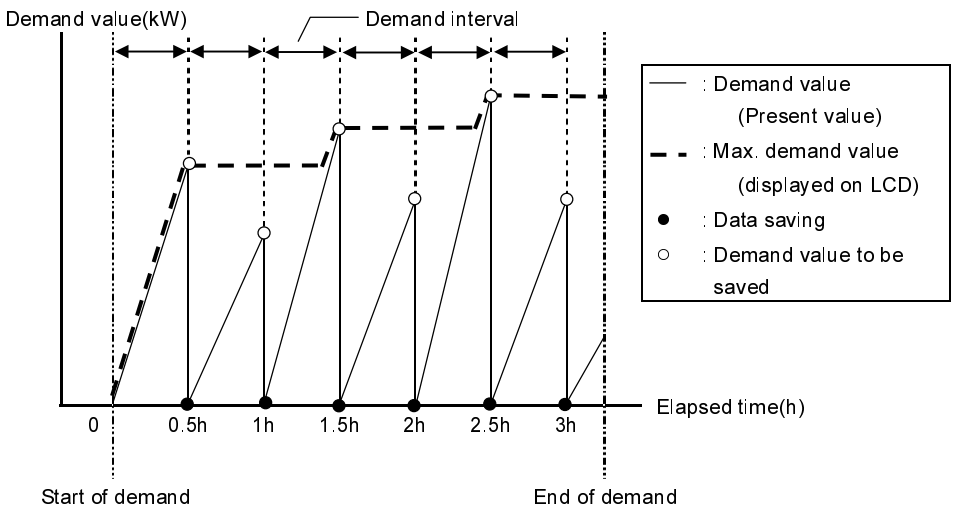

8-2 Displayed items and how to switch

Following explains about displayed items, and how to switch them. There are 3 kinds of display screens on **DEMAND** range, and the screens are common to each wiring.

- Displayed items, and how to switching them
Screens can be switched with **Cursor** keys as follows.

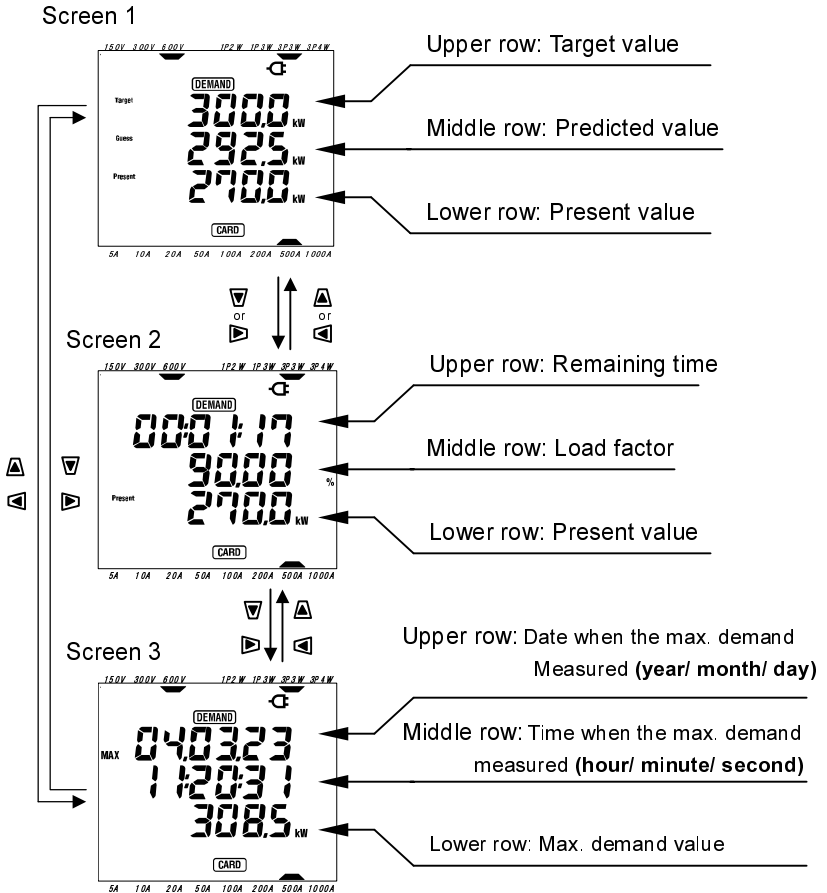

- Displayed items

<Screen 1, Upper row: Target value (W) >

It is set at "**Setting 16**". Set any value.

Target

<Screen 1, Middle row: Predicted value (W) >

The value to be displayed, when demand interval has been reached, is displayed as a predicted value (demand value) on the LCD right after the beginning of measurement.

When a load is varied, predicted value will be calculated as time goes by.

Guess

<Screen 1, Lower row & Screen 2, Lower row: Present value (W) >

This is the average power (demand value) at demand interval.

It is integration as time goes by.

Present

<Screen 2, Upper row: Remaining time>

Demand interval is counted down at every 1 sec..

<Screen 2, Middle row: Load factor (%) >

It is the ratio: present value against the target value.

Displayed as: $(\text{Present value}) / (\text{Target value}) * 100\%$

<Screen 3, Upper row & Screen 3, Middle row:

Date and time when the max. demand measured>

Date and time when the max. demand measured between the beginning and the end of measurement are displayed.

* The measured data is updated at every 1 sec. between the beginning of measurement and the 1st demand interval.

* From the 2nd demand interval or later, the measured data will be updated when a value exceeds present max. demand value.

MAX

<Screen 3, Lower row: Max. demand value (W) >

The max. demand value measured between the beginning and the end of measurement is displayed.

* The measured data is updated at every 1 sec. between the beginning of measurement and the 1st demand interval.

* From the 2nd demand interval or later, the measured data will be updated when a value exceeds present max. demand value.

MAX

8-3 How to start measurement

Following explains how to start demand measurement.

There are two methods to start measurement.

(1) Manual operation

Pressing **START/STOP** key on **DEMAND** range 2 sec. or more starts measurement.

(2) Automatic operation (specifying the date and time)

Set the start date and time on **SET UP** range (“**Setting 14**”), and then press **START/STOP** key on **DEMAND** range. The instrument becomes stand-by mode, and the measurement starts at the set date and time.

- To start measurement manually

- * Press the **START/STOP** key on **DEMAND** range 2 sec. or more.

- * File number screen is displayed for about 2 sec. (file is opened), and then it switches to measurement screen. After that, measurement starts.

At this time, LED status indicator lights up. In addition, **DEMAND** and **CARD** (*) marks appear on the measurement screen.

- * This is when data are saved to the CF card. When data are saved to the internal memory, **MEM** mark appears. (See “**Setting 19**”.)

File number screen
(displayed for about 2 sec.)



Measurement screen

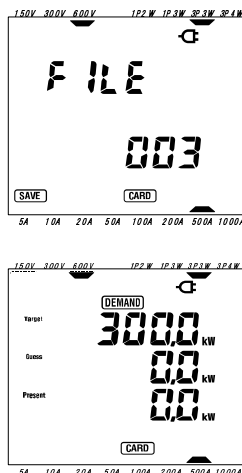

LED status indicator
lights up

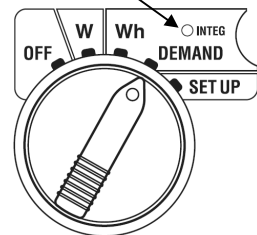

- To start measurement automatically at the set date and time

Set the start date and time on **SET UP** range.

- * Set the start date and time on **SET UP** range (“Setting 14”).
- * Then set the Function switch to **DEMAND** range, and press the **START/STOP** key.
- * File number screen is displayed for about 2 sec. (file is opened), and then it switches to measurement screen. The instrument becomes stand-by mode for measurement. LED status indicator and **DEMAND** mark blink while the instrument is on stand-by mode.

File number screen
(displayed for about 2 sec.)

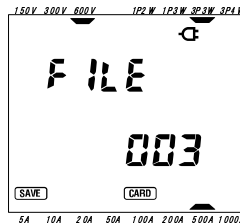

Measurement screen

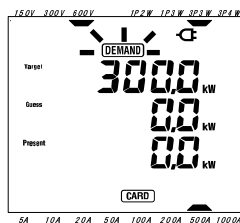

LED status indicator
blinks

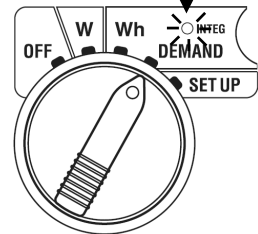

When data are saved to the CF card, **CARD** mark; when data are saved to the internal memory, **MEM** mark appears on the File number screen and measurement screen. (See “Setting19”.)

- * Measurement starts at the set date and time, and the **DEMAND** mark and the LED status indicator are being lit up. (status changed from blinking to lighting up)

NOTE

- * The **DEMAND** mark, which shows measurement/ stand-by mode, is also displayed on **W** range and **Wh** range.

NOTE

- * Set the start date and time well in advance to the present time.
Start time may have passed while making other settings.
- * When the start date and time are set to earlier than the present time, measurement starts immediately by pressing the **START/STOP** key.
- * When the start date and time are set to later than the stop date and time, measurement stops right after the start of measurement.
- * Measurement starts by manual operation when the start/ stop date and time have been set. (Press the **START/STOP** key 2 sec. or more.)
Manually starting measurement makes the start/ stop date and time settings ineffective.
- * Pressing the **START/STOP** key 2 sec. or more releases the stand-by mode.
Then **DEMAND** , **CARD** (or **MEM**) marks disappear and the LED status indicator goes off.

8-4 How to stop measurement

Following explains how to stop the measurement.

There are two methods to stop measurement.

(1) Manual operation

Pressing **START/STOP** key on **DEMAND** range 2 sec. or more stops measurement.

This action also stops the measurement started at the set date and time.

(2) Automatic operation (specifying the date and time)

Set the stop date and time on **SET UP** range (“Setting 15”).

- To stop measurement manually

* Pressing **START/STOP** key on **DEMAND** range 2 sec. or more stops the measurement. When it stops, **DEMAND** , **CARD** (in case data to be saved to CF card) marks disappear and the LED status indicator goes off.

- To stop measurement automatically at the set date and time

Set the stop date and time on **SET UP** range. (“Setting 15”)

This method is available only when the measurement is started at the set date and time. When the set date and time has been reached, **DEMAND** , **CARD** (in case data to be saved to CF card) marks disappear and LED status indicator goes off. Then measurement stops.

When measurement stops manually or automatically, **FILE** mark appears. Close the file opened at the measurement start time.

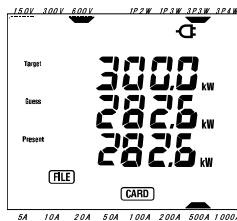

NOTE

* When data is to be saved to the internal memory, **MEM** mark kept displayed on the LCD. (indicating that a file exists in the internal memory.)

NOTE

- * Measurement also stops when turning off the instrument (set the Function switch to OFF position) but the measured data from the beginning of measurement may be lost. Measurement must be stopped manually (**START/STOP** key) or by specifying the stop date and time.
- * Manually starting measurement makes the stop date and time setting ineffective. You need to stop measurement manually in this case.
- * Measurement can be made when the period from the beginning to the end of measurement is shorter than the demand interval (“**Setting 13**”). But the measured data are not saved after measurement.
- * If the start date and time are set to later than the stop date and time, measurement stops right after the start of measurement.
- * Pressing the **START/STOP** key 2 sec. or more releases the stand-by mode. Then **DEMAND**, **CARD** (or **MEM**) marks disappear and LED status indicator goes off.

8-5 Resetting the demand value

There are three methods to reset(delete) the indication of previous measured demand values.

- * Press **ESC** key on **DEMAND** range 2 sec. or more.
- * Reset the demand value at “Setting 18”.
- * System reset

Following explains how to reset the demand value with the **ESC** key.

- * Press the **ESC** key on **DEMAND** range 2 sec. or more.
- * Then a message “oFF” (not reset) blinks. Select “on” (reset) with **Cursor** key, and press the **ENTER** key.
- *The previous measured demand value will be reset, and the integration value on **Wh** range will be reset as well.

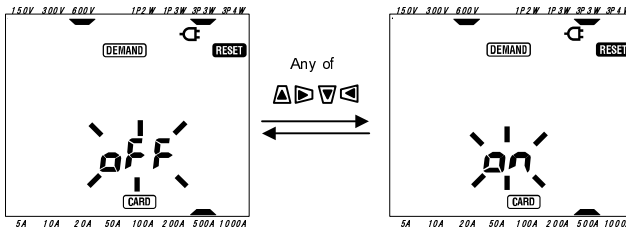

When you don't reset them, press the **ENTER** or **ESC** key while “oFF” is blinking.

NOTE

- * When keeping the integration value, start demand measurement without resetting the demand value. The items on **DEMAND** range other than max. demand value and the date and time when the max. demand measured are reset automatically.
- * Demand value cannot be reset during a measurement or while the instrument is on stand-by mode.

8-6 Saving data

Following explains how to save demand measurement data.

When integration or demand measurement starts, the measured data will be saved automatically.

There are two locations for saving data.

- * **CF card** : **Max. 20 files can be saved.**
- * **Internal memory** : **Only 1 file can be saved**

Data is saved to a CF card automatically when a CF card has been inserted before turning on the instrument. If a CF card has not been inserted, data is saved to internal memory automatically.

8-6-1 How to save

- * Start demand measurement manually or automatically. (open a file)
- * Data are saved at the demand interval ("Setting 13").

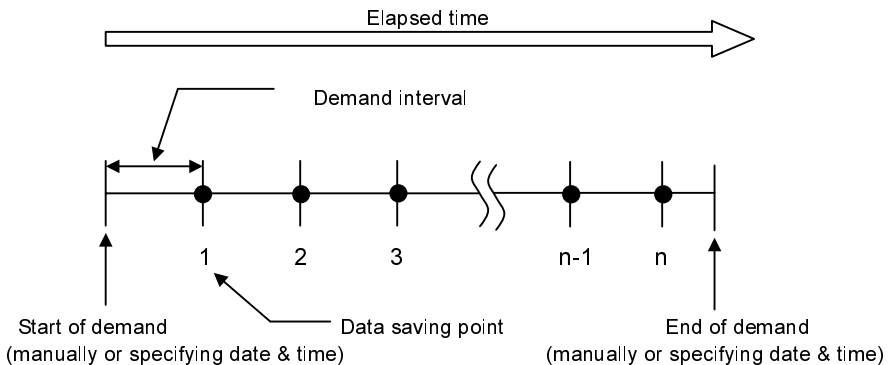

- * Stop the demand measurement manually or specifying the date and time. (close a file)
- * Measured data at the data saving point are saved to one file.

NOTE

- * Measured data can be saved to a file when measurement stops (close a file). Never set the Function switch to OFF position during a measurement. If the switch is set to OFF position, measured data from the beginning of measurement may be lost.
- * In the following case, file number becomes "001":
 - (1) the file number has exceeded 999;
 - (2) after system reset.
- * Data can be saved to the internal memory when a card has been inserted. Please refer to "Setting 19" in this manual.

8-6-2 Limitation of saving

- Limitation of saving (before measurement)

In following cases, measurement cannot be started neither by manually or automatically by pressing the **START/STOP** key.

< In case data to be saved to CF card >

- * When 20 files has been saved to the CF card; **FULL** mark appears and data will not be saved.

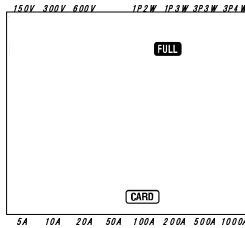

Unnecessary files shall be deleted via your PC, or all files saved to CF card shall be deleted at "Setting 21".

< In case the data to be saved to internal memory >

When previous saved data exist;

- * **MEM** mark is displayed on the LCD to indicate that there is a file in the internal memory.

Pressing the **START/STOP** key displays the screen to confirm whether you delete the file saved in the internal memory or not.

To delete the file;

- (1) The message "dAtA not .dEL" (not delete) is displayed on the screen.

Press the **Cursor** key and select "dAtA.dEL" (delete).

- (2) Then press the **ENTER** key.

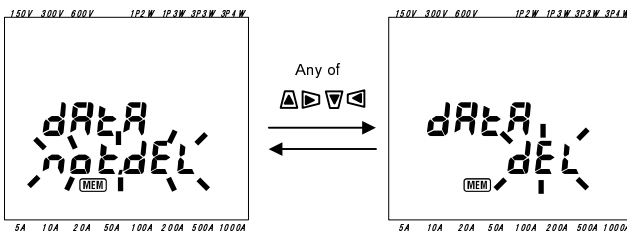

In case of manual operation, measurement starts right after deleting the data in the internal memory. When start date and time has been set, the instrument becomes stand-by mode.

- Limitation of saving (during a measurement)

When capacity of CF card or internal memory has been exceeded during a measurement; measurement continues but **FULL** mark appears on the measurement screen and data will not be saved anymore.

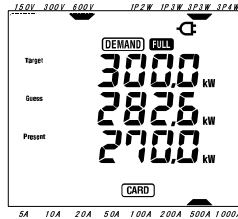

Press the **START/STOP** key 2 sec. or more and stop the measurement once. Please refer to preceding page and delete the unnecessary file.

NOTE

- * Be sure to stop measurement by pressing the **START/STOP** key. When the Function switch is set to OFF before stopping a measurement, the measured data may be lost.
- * For further details about the capacity of CF card and internal memory, please refer to “**Section 9: CF card/ Internal memory**” in this manual.

8-6-3 Save data

- Saving items (depends on each wiring)

Following items are saved to a CF card or internal memory.

- Integration measurement:

Measurement/Calculation item	
Voltage (RMS)	V : Average voltage of each phase V_i : Voltage of each phase V max : Max. value of V V_i max : Each max. value of V_i V avg : Average value of V V_i avg : Each average value of V_i
Current (RMS)	A : Average current of each phase A_i : Current of each phase A max : Max. value of A A_i max : Each max. value of A_i A avg : Average value of A A_i avg : Each average value of A_i
Active power	P : Total active power P_i : Active power of each phase P max : Max. value of P P_i max : Each max. value of P_i P avg : Average value of P P_i avg : Each average value of P_i
Skipped (See "7-5 Saving data" in this manual for further details)	
Apparent electric energy (regenerating)	-WS : Total apparent electric energy(regenerating) -WSi : Apparent electric energy of each phase (regenerating)
Apparent electric energy (overall)	#WS : Total apparent electric energy(overall) #WSi : Apparent electric energy of each phase (overall)
Reactive electric energy (consumption)	+WQ : Total reactive electric energy (consumption) +Wqi : Reactive electric energy (consumption) of each phase

- Demand measurement:

Demand value	#DEM : Total demand value #DEMi : Demand value of each phase TARGET : Target value
--------------	--

* $i = 1, 2, 3$

* "max", "avg" mean max. value and average value during an interval.

• File format and name

Measured data are saved in a CSV format, and the file name is given automatically.

File name: **3 FILE 001 . CSV**

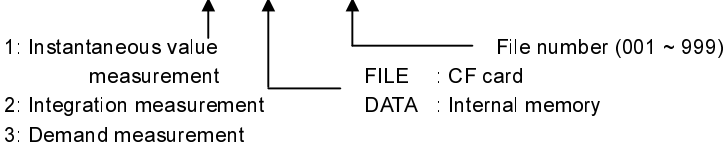

• Example of measured data

Wiring:	3P3W	← Wiring	"Setting 01"
Volt Range:	600V	← Voltage range	"Setting 02"
Current Range:	500A	← Current range	"Setting 03"
Sensor Type:	500A	← Clamp sensor	"Setting 04"
VT ratio:	1	← VT ratio	"Setting 05"
CT ratio:	1	← CT ratio	"Setting 06"
Interval	30min	← Demand interval	"Setting 13"
START	2004/03/23_08:30:00	← Demand start date & time	

	DATE	TIME	ELAPSED TIME	V1	V2	V3	Q3	f	In
1	2004/03/23	09:00:00	00000:30:00						
2	2004/03/23	09:30:00	00001:00:00						
n									

V1 max	V2 max	V3 max	Q3 max	F max	In max	V1 avg	V2 avg	V3 avg	Q3 avg	F avg	In avg

+ WP	+ WP1	+ WP2	- WP3	# WP	# WP1	# WP2	# WP3	+ WS	# DEM2	# DEM3	TARGET

Data will be displayed in index format.(e.g. 110.5kW, "1.105E+5".)

8-7 Digits/ Over-range indication

Following explains about digits to be displayed and over-range indication.

- Digits

- * **Predicted value (Guess), Present value (Present):** max 6 digits

The digits of the predicted and present values are corresponding to the target value (“**Setting16**”) as follows.

Target value (“ Setting 16 ”)	Digit and decimal point
0.1 ~ 999.9 W	99999.9 W
0.1 ~ 999.9 kW	99999.9 kW
0.1 ~ 999.9 MW	99999.9 MW
0.1 ~ 999.9 GW	99999.9 GW

- * **Load factor (%)**:max 6 digits 9999.99%

- Over-range indication/ others

When the predicted value, present value(max demand value) and load factor exceed 99999.9, segment becomes “**OL**”.

* When the input voltage and the current exceeds the max display counts, **V_{OL}** or **A_{OL}** mark is displayed on the LCD. In this case, accurate measurement might not be made.

* On **W** range, when P (active power) is indicated by bars “- - -”, the increase on present value is regarded as 0.

Please refer to “**6-5-2 Over-range indication/ Bar indication**” in this manual.

9. CF card/ Internal memory

Following explains about CF card and the Internal memory.

9-1 Instrument and CF card/ Internal memory

Measured data can be saved in CF card and the internal memory of the instrument.

- CF card

- * Available capacity

32M/ 64M/ 128MB (CF card with more or less capacity cannot be used.)

- * Slot type

Type I/ II

- * Format

FAT16

- * CF card (operation check has completed)

Supplier	Model	Capacity
SanDisk Corporation	SDCFB-32	32MB
	SDCFB-64	64MB
	SDCFB-128	128MB
Renesas Technology Corporation	HB28B128C8C	128MB
Adtec co., Ltd.	AD-CFG32	32MB
BUFFALO Inc.	RCF-X32MY	32MB
	RCF-X64MY	64MB
	RCF-X128MY	128MB

* Company name and model name are the trademark or the registered trademark.

- * Max. number of files can be saved in the instrument:

20 files

- Internal memory

- * Memory type

EEPROM

- * Storage capacity

128kB

- * Max. number of files can be saved in this instrument:

1 file

- * Data communication method

USB communication

(See “**Section 10: Communication/ Supplied software**” in this manual.)

- Max number of data (reference)

Data saved in:		CF card			Internal memory
Capacity		32MB	64MB	128MB	128kB
Instantaneous measurement		100,000 data	200,000 data	400,000 data	1,000 data
Integration/ demand measurement interval	1sec	7 hours	14 hours	28 hours	4 minutes
	1min	18 days	36 days	72 days	4 hours
	30min	1 year or more			5 days

* In case that no file exist in the CF card.

NOTE

- * Be sure to verify proper operation of CF card on a well-known hardware.
- * As to the manipulation of the CF card, please refer to the instruction manual attached to the card.
- * The available recoding period varies depending on each interval.
- * In order to save the data without any problem, make sure to delete the file other than the data measured with this instrument in the CF card.

9-2 Placing / removing the CF card

DANGER

- Never open the CF card connector cover during a measurement.

WARNING

- When placing or removing the CF card, be sure to remove the Voltage test leads and Clamp sensor from the instrument and set the Function switch to OFF position.

CAUTION

- Be sure to set the Function switch to OFF position before placing or removing a CF card. If a CF card is placed/removed while the instrument is on, saved data or instrument may be damaged.

- How to place:

- (1) Loosen the CF card cover-fixing screw, and open the cover.
- (2) Turn the CF card obverse side up, and firmly place it in the CF card connector. Then the Eject button is popped-out.
- (3) After inserting the card, close the CF card cover and tighten the screw.

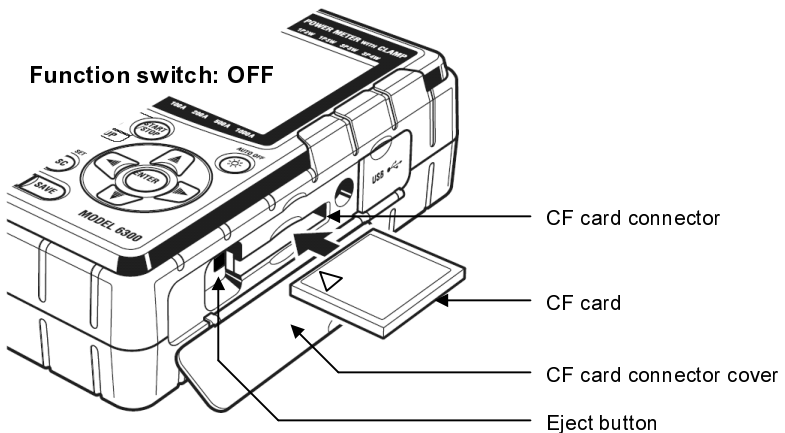

- How to remove:

- (1) Loosen the CF card cover-fixing screw, and open the cover.
- (2) The card can be removed by pushing the Eject button beside the card connector. The Eject button is being pressed down.
- (3) Remove the card, and then close the CF card cover and tighten the screw.

NOTE

- * When placing the CF card in the connector, pay attention to the orientation of the arrow mark indicated on the obverse side of the CF card.

9-3 Formatting or saving data in CF card/ Internal memory

- Formatting CF card (FAT16)

Be sure to format the CF card to be used.

<Format procedure>

- (1) Confirm that the instrument is off, and place the CF card.
- (2) Set the Function switch to **SET UP** range. (Instrument is turned on)
- (3) Follow the procedure described in “Section 4; **Setting 20**” and format the card.

- Deleting of all files

When deleting all files in the CF card and the internal memory, follow the procedure below.

* In case of deleting all data in the CF card:

Follow the procedure described in “Section 4; **Setting 21**” and delete the data.

* In case of deleting all data in the internal memory:

Follow the procedure described in “Section 4; **Setting 22**” and delete the data.

- Saving data

Measured instantaneous, integration and demand values can be saved to the CF card or the internal memory in CSV format, which can be edited on spreadsheet software. File number is given automatically.

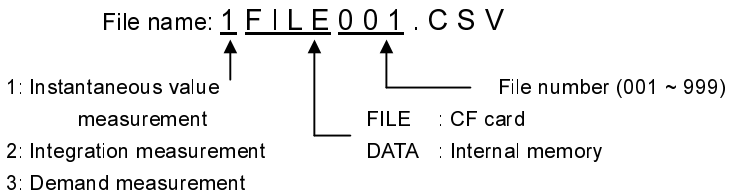

For further details, please refer to; “**6-4 Saving data**” for instantaneous value, “**7-5 Saving data**” for integration value and “**8-6 Saving data**” for demand value.

NOTE

- * Instrument automatically identifies a CF card when it is turned on.
- * When a card is inserted, data can be saved in the internal memory. Please refer to “**Setting 19**”.

10. Communication function/ Supplied software

Following explains data communication between this instrument and your PC, and also explains how to install and operate the supplied software.

- Interface

This instrument is equipped with USB interface.

Communication method: USB Ver1.1

Followings can be done by USB communication:

- * Downloading a file in the internal memory of the instrument to PC
- * Making settings of the items on **SET UP** range via PC.

- Software

KEW POWER PLUS (supplied CD-ROM)

- System requirements

- * OS (Operation system)

Windows 98/ Me/ 2000/ XP (CPU: Pentium II 200MHz or higher)

- * Memory

64Mbyte or more

- * Display

Resolution 800 x 600 dots, 65536 colors or more

- * Hard-disk space required

100Mbyte or more

- Trademark

- * Windows[®] and Microsoft[®] Excel are the registered trademark of Microsoft in the United States.

- * Pentium is a registered trademark of Intel in the United States.

10-1 Install (KEW POWER PLUS)

Following explains how to install "KEW POWER PLUS".

- (1) Followings shall be checked before installing "KEW POWER PLUS".
 - * To prepare your system to install this software, please close all open programs.
 - * Be sure NOT to connect the instrument with USB until install is completed.
 - * On Windows2000/ XP, install shall be done with administrative right.
- (2) Place the CD "KEW POWER PLUS" in your PC's CD-ROM drive. Then, KEW POWER PLUS installer sets up automatically. When it doesn't run automatically, double click the "setup_j.exe".

Then, following window appears. Click "Next".



- (3) Please read through and understand the License Agreement, and check "I accept...". Then click "Next".

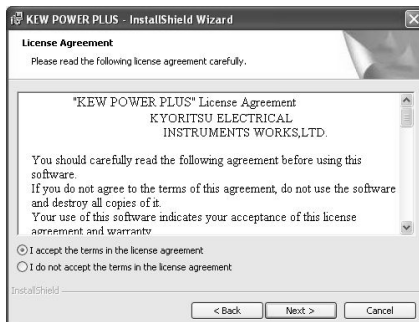

- (4) Please enter the user information and specify the location to where install the software. Then click "Next".

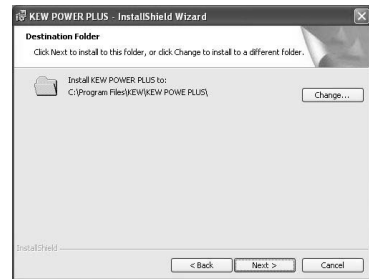
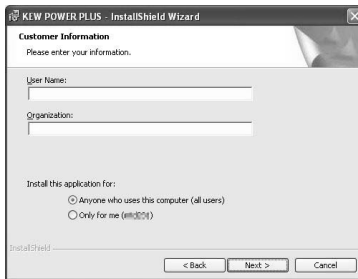

- (5) Confirm the information on install, and click "Install" to start installing.

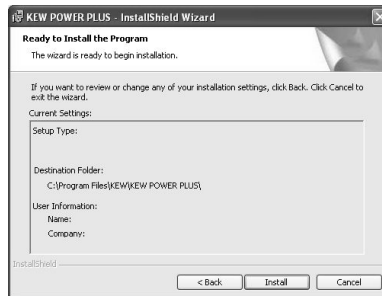

- (6) Click "Finish" when install completes.

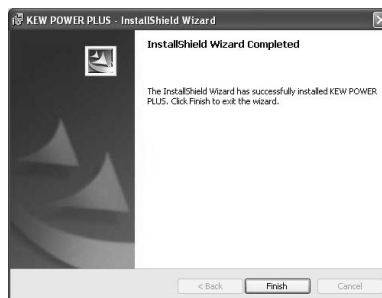

NOTE

- * If you need to remove "KEW POWER PLUS", use the "Add/Remove Programs" tool in Control Panel.

10-2 Install (USB driver)

- (1) Connect USB cord to your PC.
- (2) Set the Function switch on the instrument to **SET UP** range and connect the other end of USB cord to the instrument.

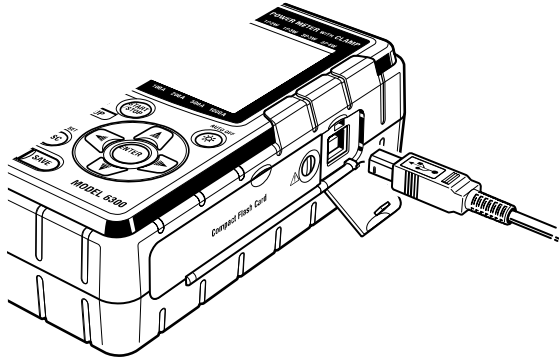

- (3) When your PC and the instrument are connected properly, install starts.

In case that following window appears on Windows XP, click "Continue anyway". (It is an operation check, and no problem happens if install is continued.)



NOTE

- * When install of the driver is interrupted and reinstall cannot be done, or when install cannot be done properly, please refer to "10-7 Uninstall (USB driver)".

- (4) Click “Install the software automatically (recommended)”, and place the “KEW POWER PLUS” in your PC’s CD-ROM drive. Then Click “Next”.



- * When a device driver is not found automatically, click “kew_power.inf” of KEW LOG Soft, which is in the CD-ROM drive.

- (5) Install is completed when the wizard has finished. Click “Finish”.



10-3 Start “KEW POWER PLUS”

- Start and quit

Start the software by; 1) clicking the icon for “KEW POWER PLUS” on the desktop, or 2) clicking “Start” → “Program” → “KEW” → “KEW POWER PLUS”. Then the main window for “KEW POWER PLUS” appears. Please click “Download” or “Setup”. Clicking “Exit” or “x” box at the upper right of the window quits the program.

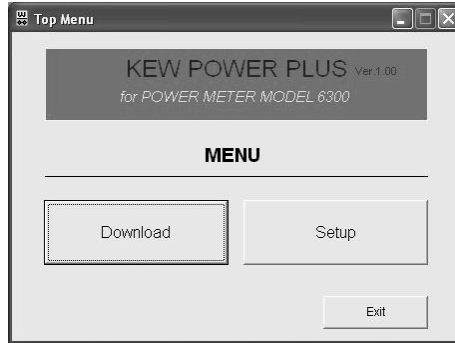

- **“Download”**: downloads the file in the internal memory of the instrument.

When data have recorded in the internal memory of the instrument, it can be saved to PC in CSV format. The saved data can be loaded in Microsoft® Excel, and be edited and printed.

(CSV format : is a comma-separated text data, and can be loaded in Microsoft® Excel.)

- **“Setup”**: makes setting for instrument.

Can make settings for the items on **SET UP** range and confirm the present settings on your PC. Moreover, settings can be saved/called as a “configuration file (.kps)”. So the settings can be changed easily via PC.

* When using this instrument for the first time, please set the time.

10-4 Connecting the instrument and PC

Confirm that the Function switch on the instrument is set to **SET UP** range and the instrument and your PC are connected with USB. Clicking “Download” or “Setup” displays detection window.

< When instrument is detected properly >

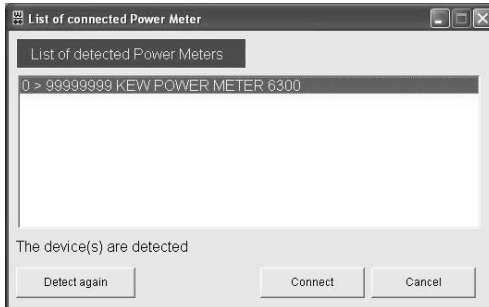

< When no instrument is detected >

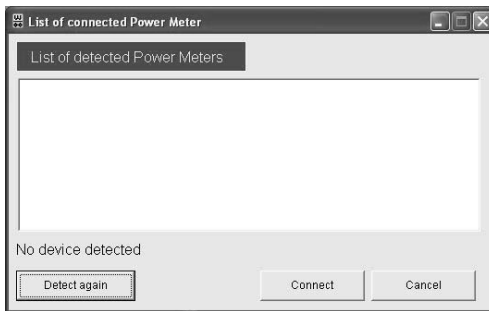

When the instrument is detected properly, click “Connect”. Then “DOWNLOAD” or “Setup” window appears.

If the instrument is not detected, remove and connect the USB cord, and then click “Detect again”. There is other possibility that the install of USB driver has not completed properly. Please refer to “**10-7 Uninstall (USB driver)**” and reinstall the USB driver.

The PC may not detect the connected Power Meter or error message appears during data transfer, even if the PC and the Power Meter are connected correctly because of static electricity, etc. In this case, message is displayed on the PC screen. Please insert and extract the USB cord once according to the message, and transfer the data again.

10-5 Download to PC

- (1) Connect the instrument and your PC with USB cord, and set the Function switch to **SET UP** range.
- (2) Start “KEW POWER PLUS”, and click “Download” on the main window.
- (3) Select the instrument displayed on the “List of detected Power Meters”. Then click “Connect”.
- (4) When the instrument and your PC are connected properly, “DOWNLOAD” window appears. When error message appears, please check whether USB cord is connected properly; or the instrument is on and the Function switch is set to **SET UP** range or not.

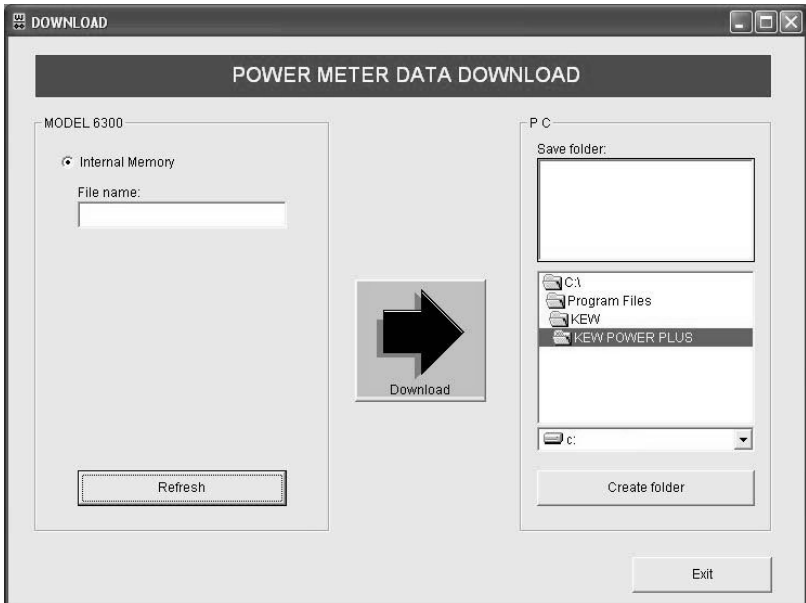

(5) Click “Refresh”.

When the data exists in the internal memory of the instrument, the file name will be displayed in the box for File name. In case that no data exists, file name is not displayed and download cannot be done. First, save data with this instrument, then do downloading.

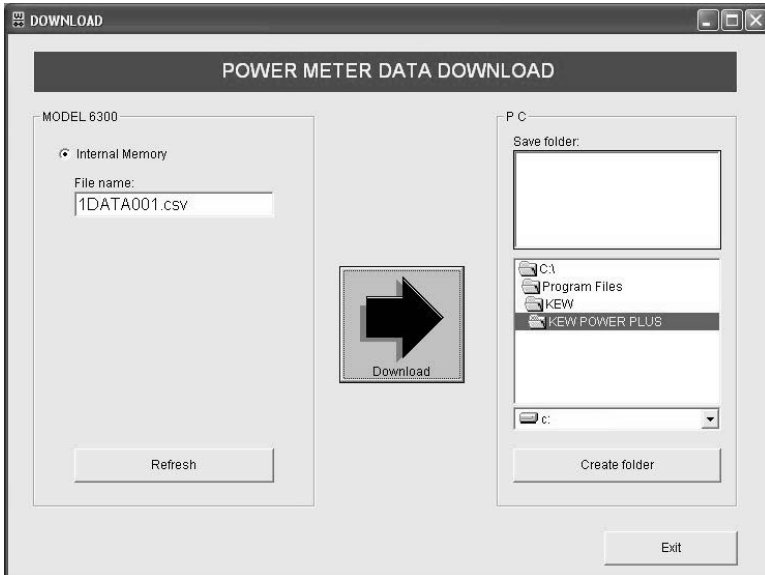

(6) Specify the folder in which download the data.

(7) Check the file name and the folder in which download the data, and then click “Download”. Then data transmission starts.

(8) When bar graph reaches the right edge, it means download completes. The saved data can be edited on the software like Excel, and be printed out.

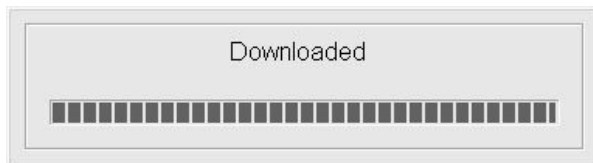

10-6 Set up via PC

- (1) Connect the instrument and your PC with USB cord, and set the Function switch to **SET UP** range.
- (2) Start “KEW POWER PLUS”, and click “Setup” on the main window.
- (3) Select the instrument displayed on the “List of detected Power Meters”. Then click “Connect”.
- (4) The window for “MODEL6300 POWER METER SETUP” appears. When error message appears, please check whether USB cord is connected properly; or the instrument is on and the Function switch is set to **SET UP** range or not.

MODEL 6300 POWER METER SETUP

General

Wiring: 3-phase 3-wire(3P3W)

V-range: 300V

A-range: 200A

Sensor: Type 500A(50 to 500A)

VT ratio: 1

CT ratio: 1,00

Buzzer: ON

Card: ON

Time of Integration

Start: 19/03/2004 08 : 58 : 00

End: 19/03/2004 09 : 28 : 00

Interval: 30min.

Demand measurement

Start: 19/03/2004 08 : 58 : 00

End: 19/03/2004 09 : 28 : 00

Interval: 30min.

Target value: 100,0 kW

Cycle: 10min.

(5) Buttons

“Send”

Can transfer the SET UP items for the instrument, which have been set on your PC, to the instrument. Please make settings according to the environment. After making necessary settings, click this button.

Then the settings will be reflected on the **SET UP** range of the instrument.

“Confirm”

Can check the SET UP items for the instrument.

Clicking this button loads and displays the SET UP items for the instrument. The set values before loading are overwritten.

Be sure to save the important settings prior to load other settings.

“Initial value”

Returns all settings to the initial value.

As to the initial value, please refer to “**Section 4: Settings**”.

“Set Date/Time from PC”

Adjusts the time of the instrument to the time on your PC. Can set date and time (hour & minute are settable) by clicking this button. Please set the time on your PC to the present time first.

“Save”

Can save the settings as configuration file. (*.kps)

Setting corresponding to each environment can be saved.

If the configuration file is saved together with the recorded data, record/measurement conditions can be checked as well.

“Configuration file”

Opens the saved configuration files. (*.kps)

If the settings corresponding to an environment have been saved, you can switch the setting to the proper one immediately.

If the configuration file is saved as conditions for record/measurement, settings at that time can be checked as well.

“Exit”

Closes the setting screen.

NOTE

- * For further details about each setting items, please refer to “**Section 4: Setting**”.

10-7 Uninstall (USB driver)

When install of the USB driver is interrupted and reinstall cannot be done, please follow the procedure below and delete the existing USB driver. Then install it again.

- (1) Connect a PC and the instrument with a USB cord.
- (2) Click “Control Panel” in the Start menu at the lower left on the Windows screen.
- (3) Click “System” in the control panel.
- (4) Then click “Device Manager”.
- (5) Right click on “KEW POWER METER 6300” in the “Universal Serial Bus controllers”.
- (6) Click “Uninstall” and uninstall the USB driver.

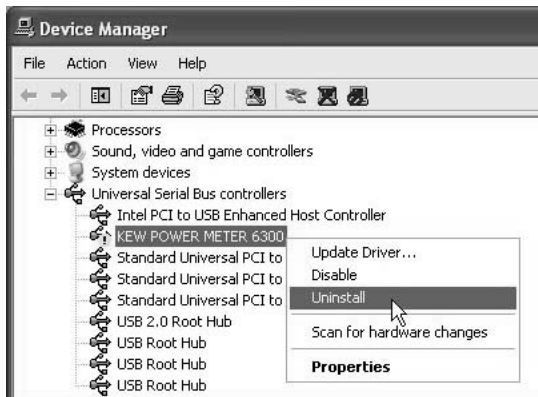

- (7) Remove the USB cord connecting your PC and the instrument once, and connect them again.
- (8) When “Found New Hardware Wizard” window appears, please follow the procedure described at “10-2 Install (USB driver)” and install the driver.

11. Other functions

Following explains about additional functions.

- Time (clock)

This instrument has clock function, and the time is set to Japan time by default. On **SET UP** range, date/time information can be viewed or changed. Please refer to “**Setting 07**”.

- Backlight

Pressing the **BACKLIGHT** key () switches on/off the backlight for LCD. The backlight is automatically turned off when it remains on for about 5min.

- Data hold

The indicated value on the LCD is held by pressing the **DATAHOLD** key (), and “**H**” mark appears on the LCD.

At this bout, the instrument is performing calculation and data save.

Data hold function works on each range as follows.

“Available” : Pressing the **DATAHOLD** key holds the indicated value.

The values on each measurement are also held.

“Invalid” : Data hold function doesn't operate even if the **DATAHOLD** key is pressed.

Status	Data hold function on each range			
	W range	Wh range	DEMAND range	SET UP range
Measuring instantaneous value	Available	Invalid		
Stand-by for integration	Invalid			
Measuring integration value	Available		Invalid	
Stand-by for demand	Invalid			
Measuring demand value	Available			Invalid



Data hold function is released and “**H**” mark disappears by pressing the **DATAHOLD** key again. This function can be released on any range.

NOTE

* Keys are locked by pressing the **DATAHOLD** key 2 seconds or more either data hold function is on or off. If both Data hold and Key lock functions are enabled at the same time, data hold function cannot be released until the key lock function is released.

* When the Function switch is set to OFF, both functions are released.

- Key lock

Keys are locked by pressing the **DATAHOLD** key () 2 seconds or more, and “” mark appears on the LCD. Then all keys other than Function switch and **BACKLIGHT** key are disabled. Key lock function is released by pressing the **DATAHOLD** key 2 seconds or more again, and the “” mark disappears.

NOTE

- * Pressing the **DATAHOLD** key 2 seconds or more activates data hold function.
- * If both data hold and key lock functions are enabled at the same time, Data hold function cannot be released until the Key lock function is released.
- * When the Function switch is set to OFF, both functions are released.

- System reset

Settings on each range changes after system reset as follows.

Range	After system reset
W range	Customized items return to the initial value.
Wh range	Previous integration value remains on the LCD is reset.
DEMAND range	Previous demand value remains on the LCD is reset.
SET UP range	Each setting item returns to the initial value.(*)
Others	* A file in the internal memory is deleted. * When saving data, file number for CF Card or internal memory becomes 001. (If the same file name exists, the old one will be overwritten.)

* A part of settings don't return to the initial value.

For further details, please refer to “**4-1 List of setting items**”.

System reset can be done in either of following tow methods.

- (1) Follow the procedure described at “**Setting 23**” on **SET UP** range. Please refer to “**4-3-23 System reset**”.
- (2) Press the **ESC** key () and operate the Function switch. Set the Function switch from OFF to any range while the **ESC** key is being pressed down. The **ESC** key shall be kept pressed down until the setting or measurement screen for the selected range appears.

Now, system reset completes.

12. When defect or breakdown is suspected

Following explains how to deal the problems found on the instrument.

12-1 Trouble-shooting

When defect or breakdown of the instrument is suspected, please be sure to check following points. If your problem does not appear in this section, please contact the distributor from who you purchased this instrument.

Symptom	Check
1. No indication when the Function switch is set to other than OFF.	<ul style="list-style-type: none"> * Confirm that: <ol style="list-style-type: none"> 1) the Power cord is connected to the outlet properly. 2) there is no break in the Power cord. 3) supply voltage is within the allowable range.
2. Error code appears when turning on the instrument.	<ul style="list-style-type: none"> * Error code below appears when turning on the instrument. <div style="text-align: center; font-family: monospace; font-size: 1.2em; font-weight: bold;">Err001 ~ Err063</div> Internal circuit may be damaged. Contact us or the distributor from who you purchased this instrument.
3. Any key doesn't work	<ul style="list-style-type: none"> * Check if key lock function "  " is activated or not. * Confirm the available keys on each range
4. Error code appears while making setting.	<ul style="list-style-type: none"> * Error message appears in the following cases <div style="text-align: center; font-family: monospace; font-size: 1.2em; font-weight: bold;">SEtErr</div> * If the settings on Voltage range ("Setting 02"), Current range ("Setting 03"), VT ratio ("Setting 05") and CT ratio ("Setting 06") are as indicated below, this error code appears. Please make setting again. $(\text{Voltage range}) \times 120\% \times (\text{Current range}) \times 120\% \times (\text{VT ratio}) \times (\text{CT ratio}) > 9999G \quad (G=10^9)$ * If the day that does not exist has been set as integration start date and time ("Setting 10") or as demand start date and time ("Setting 14").
5. Indicated values are not stable, or not correct.	<ul style="list-style-type: none"> Confirm that: <ul style="list-style-type: none"> * voltage test leads and clamp sensors are connected properly. * setting and wiring on the instrument against the line under test are appropriate. * there is no break in the voltage test leads. * input signal is not interfered. * strong electric magnetic field does not exist in close proximity. * environment meets the specification of this instrument.

<p>6. Data cannot be saved in the CF card</p>	<ul style="list-style-type: none"> * Confirm that the instrument recognizes CF card. (“Setting 19”). * Check the max number of file or capacity of CF card to be used. * Confirm that the operation of CF card to be used is checked. * Verify the proper operation of CF card on a well-known hardware. * Please format the CF card. (“Setting 20”)
<p>7. Saved file in the CF card doesn't contain the measured data.</p>	<p>In following cases, measured data won't be recorded in files.</p> <ul style="list-style-type: none"> * File wasn't closed (set the Function switch to any position other than OFF and W range) after instantaneous value is saved by pressing the SAVE key on the W range. (see “6-4 Saving data”) * The period from the beginning to the end of integration/demand measurement is shorter than the interval. * Set the Function switch to OFF position before integration/ demand measurement ends.
<p>8. Download and setting cannot be done via USB communication.</p>	<p>Confirm that:</p> <ul style="list-style-type: none"> * the instrument and your PC are connected with USB cord correctly. * the Function switch is at SET UP range.

12-2 Battery replacement

Following explains how to replace batteries.

When the battery mark indicated on the LCD becomes "  ", batteries are almost exhausted.

- Be sure to check following points.

DANGER

- Never open the Battery cover during a measurement.

WARNING

- Be sure to remove Power cord, Voltage test leads and Clamp sensors from the instrument and set the Function switch to OFF position before replacing batteries.

CAUTION

- Do not mix new and old batteries.
- Make sure to install batteries in correct polarity as marked inside.

- Battery
 - Alkaline size AA battery
 - LR6 (1.5V) x 6pcs
- How to replace batteries
 - (1) Loosen two Battery cover-fixing screws, and remove the Battery cover.
 - (2) Install new batteries in correct polarity as marked inside.
 - (3) Then put the Battery cover and tighten up the screws.

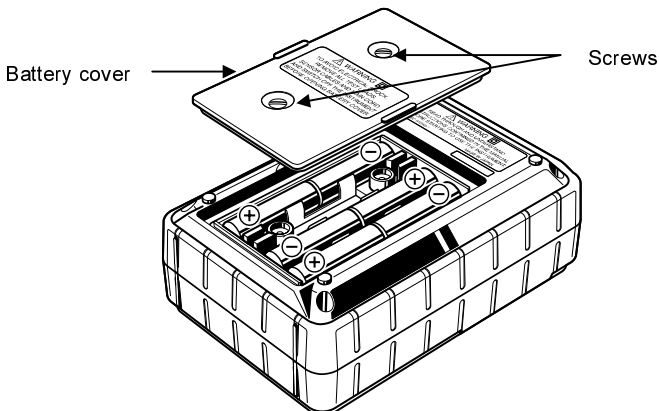

13. Specification

13-1 General specification

Location for use	In door use, Altitude up to 2000m
Temperature&humidity Range (guaranteed accuracy)	23°C±5°C/Relative humidity 85% or less (no condensation)
Operating temperature & humidity range	0°C~50°C/Relative humidity 85% or less (no condensation)
Storage temperature & humidity range	-20°C~60°C/Relative humidity 85% or less (no condensation)
Measured line	single-phase 2-wire (1ch ~ 3ch), single-phase 3-wire, three-phase 3-wire, three-phase 4-wire
Withstand voltage	AC5320V/ for 5 sec. between (voltage input terminal) and (enclosures) AC3320V/ for 5 sec. between (voltage input terminal) and (power supply, USB connector) AC2710V/ for 5 sec. between (power connector) and (USB connector, current input terminal, enclosures)
Insulation resistance	50MΩ or more / 1000V between (voltage/ current input terminal, power connector) and (enclosures)
Display	Liquid crystal display (segment type)
Indication renewal	every 1 sec.
Backlight	Pressing the backlight key switches the light on/off. (Light is automatically turned off after 5 minute.)
Rated AC power supply voltage	100V ~ 240V ± 10% (45~65Hz) 10VA max.
Rated DC power supply voltage	9V (Alkaline size AA battery (LR6) 1.5V x 6pcs) Current consumption 180mA typ. (7 hours continuous measurement/ at LR6 is used)
Applicable standard	IEC61010-1 Measurement CAT. III 600V, Pollution degree 2 IEC61010-031, IEC61326 (Class A)
Dimension	175(L) x 120 (W) x 65 (D) mm
Weight	approx. 800g (including batteries)

Accessories	Voltage test leads MODEL7141 x 1set (red/ green/ black/ blue, 1pce for each) Power cord MODEL7170 x 1pce USB cord MODEL7148 x 1pce Alkaline size AA battery (LR6) x 6pcs CD-ROM x 1pce Communication soft ware (KEW POWER PLUS) Instruction manual (PDF file) Quick manual x 1pce Carrying Case MODEL9125 x 1pce
Optional	Compact flash card 32MB MODEL8125 (Clamp sensor 500A type) MODEL8126 (Clamp sensor 200A type) (available in the near future) MODEL8127 (Clamp sensor 100A type) (available in the near future)

Lineup of Clamp sensors has not been completed yet. For further information about Clamp sensor, please contact the distributor from who purchased the instrument.

13-2 Instantaneous value measurement**(1) Voltage V_i [V]**

Range	150/ 300/ 600V
Displayed digit	4 digits
Allowable input	10 ~ 110% of each range
Display range	5 ~ 120% of each range
Crest factor	2.5 or less
Accuracy	$\pm 0.3\% \text{rdg} \pm 0.2\% \text{f.s.}$ (sine wave 45 ~ 65Hz)
Instantaneous overload	720V (for 10 sec.)
Input impedance	Approx. 2.7M Ω

(2) Current A_i [A]

Range	50A type : 5/ 10/ 20/ 50A (500mV / 50A = 10mV / A) 100A type : 10/ 20/ 50/ 100A (500mV / 100A = 5mV / A) 200A type : 20/ 50/ 100/ 200A (500mV / 200A = 2.5mV / A) 500A type : 50/ 100/ 200/ 500A (500mV / 500A = 1mV / A) 1000A type : 100/ 200/ 500/ 1000A (500mV / 1000A = 0.5mV / A) 3000A type : 1000/ 3000A (3000A: CT=3.00) (500mV / 1000A, 3000A = 0.5mV, 0.167mV / A)
Displayed digit	4 digits
Allowable input	10 ~ 110% of each range
Display range	1 ~ 120% of each range
Crest factor	3.0 or less (each range: 90% or less)
Accuracy	$\pm 0.3\% \text{rdg} \pm 0.2\% \text{f.s.}$ + accuracy of clamp sensor (sine wave: 45 ~ 65Hz)
Instantaneous overload	120% of the rated current of each clamp sensor (for 10 sec.)
Input impedance	Approx. 100k Ω

(3) Active power P_i [W]

Range	(Voltage range) x (Current range)
Displayed digit	4 digits
Accuracy	$\pm 0.5\% \text{rdg} \pm 0.2\% \text{f.s.}$ + accuracy of clamp sensor (power factor: 1, sine wave: 45 ~ 65Hz)
Effect of power factor	$\pm 1.0\% \text{rdg}$ (indicated value: power factor 0.5 against power factor 1)
Polarity indication	Consumption : +(no mark), Regeneration: -

(4) Frequency f [Hz]

Measuring range	40.0 ~ 70.0Hz
Displayed digit	3 digits
Allowable input	10 ~ 110% of each voltage range (sine wave 45 ~ 65Hz)
Accuracy	$\pm 3 \text{dgt}$
Input source	Detect from V1 (voltage between voltage input terminals: VN and V1)

(5) Calculation items and equations

Item	Wiring	Equation	
Active power	1P2W (1ch)	$P = P1$	
	1P2W (2ch)	$P = P1 + P2$	
	1P2W (3ch)	$P = P1 + P2 + P3$	
	1P3W	$P = P1 + P2$	
	3P3W	$P = P1 + P2$	
	3P4W	$P = P1 + P2 + P3$	
Apparent power	1P2W (1ch)	$S = V \times A$	
	1P2W (2ch)	$S_i = V \times A_i \quad (i=1,2)$	$S = S1 + S2$
	1P2W (3ch)	$S_i = V \times A_i \quad (i=1,2,3)$	$S = S1 + S2 + S3$
	1P3W	$S_i = V_i \times A_i \quad (i=1,2)$	$S = S1 + S2$
	3P3W	$S_i = V_i \times A_i \quad (i=1,2)$	$S = \sqrt{3}/2 (S1 + S2)$
	3P4W	$S_i = V_i \times A_i \quad (i=1,2,3)$	$S = S1 + S2 + S3$
Reactive power (*1, *2)	1P2W (1ch)	$Q = \sqrt{S^2 - P^2}$	
	1P2W (2ch)	$Q_i = \sqrt{S_i^2 - P_i^2} \quad (i=1,2)$	$Q = Q1 + Q2$
	1P2W (3ch)	$Q_i = \sqrt{S_i^2 - P_i^2} \quad (i=1,2,3)$	$Q = Q1 + Q2 + Q3$
	1P3W	$Q_i = \sqrt{S_i^2 - P_i^2} \quad (i=1,2)$	$Q = Q1 + Q2$
	3P3W	$Q_i = \sqrt{S_i^2 - P_i^2} \quad (i=1,2)$	$Q = Q1 + Q2$
	3P4W	$Q_i = \sqrt{S_i^2 - P_i^2} \quad (i=1,2,3)$	$Q = Q1 + Q2 + Q3$
Power factor (*1)	1P2W (1ch)	$PF = \left \frac{P}{S} \right $	
	1P2W (2ch)	$PF_i = \left \frac{P_i}{S_i} \right \quad (i=1,2)$	$PF = \left \frac{P}{S} \right $
	1P2W (3ch)	$PF_i = \left \frac{P_i}{S_i} \right \quad (i=1,2,3)$	$PF = \left \frac{P}{S} \right $
	1P3W	$PF_i = \left \frac{P_i}{S_i} \right \quad (i=1,2)$	$PF = \left \frac{P}{S} \right $
	3P3W	$PF_i = \left \frac{P_i}{S_i} \right \quad (i=1,2)$	$PF = \left \frac{P}{S} \right $
	3P4W	$PF_i = \left \frac{P_i}{S_i} \right \quad (i=1,2,3)$	$PF = \left \frac{P}{S} \right $
Neutral current (*3)	$I_n = \sqrt{\{A1 + A2 \cos(\theta2 - \theta1) + A3 \cos(\theta3 - \theta1)\}^2 + \{A2 \sin(\theta2 - \theta1) + A3 \sin(\theta3 - \theta1)\}^2}$ <p style="text-align: center;">* $\theta1, \theta2, \theta3$: phase difference of A1, A2, A3 against V1</p>		

* 1: The plus/minus sign is displayed by multiplying the polarity obtained based on varmeter method.

+ (no polarity): Delay phase (inductivity), - : Advance phase (capacitive)

* 2: For distorted or unbalance wave inputs, there may be discrepancies between this instrument and others that operate based on different measurement principals.

* 3: Can be measured only at making settings for 3P4W (three-phase 4-wire).

13-3 Integration value measurement

(1) Active electric energy WP [Wh]

Displayed item	Consumption(Total: $+WP$, each phase: $+WP_i$) * Regeneration and overall: Data is saved only.	
Display range	0.00Wh ~ 999999GWh (digit and unit is adjusted to $+WS$)	
Displayed digit	6 digits (decimal position, unit is adjusted to $+WS$)	
Equation	Consumption ($+WP$)	Each phase: $+WP_i = \sum \frac{(+P_i)}{h}$, Total: $+WP = \sum (+WP_i)$
	Regeneration ($-WP$)	Each phase: $-WP_i = \sum \frac{(-P_i)}{h}$, Total: $-WP = \sum (-WP_i)$
	Overall (ΣWP)	Each phase: $\Sigma WP_i = (+WP_i) + (-WP_i)$ Total: $\Sigma WP = \sum (\Sigma WP_i)$

* Consumption (+Pi) : when P>0, Regeneration(-Pi) : when P<0 * t_h : time of integration

* $i=1$: 1P2W (1ch), $i=1,2$: 1P2W(2ch)/ 1P3W/ 3P3W, $i=1,2,3$: 1P2W(3ch)/3P4W

(2) Apparent electric energy WS [VAh]

Displayed item	Consumption(Total: $+WS$, each phase: $+WS_i$) * Regeneration and overall: Data is saved only.	
Display range	0.00VAh ~ 999999GVAh (digit and unit is adjusted to $+WS$)	
Displayed digit	6 digits (decimal position, unit is adjusted to $+WS$)	
Equation	Consumption ($+WS$)	Each phase: $+WS_i = \sum \frac{(+S_i)}{h}$, Total: $+WS = \sum (+WS_i)$
	Regeneration ($-WS$)	Each phase: $-WS_i = \sum \frac{(-S_i)}{h}$, Total: $-WS = \sum (-WS_i)$
	Overall (ΣWS)	Each phase: $\Sigma WS_i = (+WS_i) + (-WS_i)$, Total: $\Sigma WS = \sum (\Sigma WS_i)$

* Consumption (+Si) : when P>0, Regeneration(-Pi) : when P<0 * t_h : time of integration

* $i=1$: 1P2W (1ch), $i=1,2$: 1P2W(2ch)/ 1P3W/ 3P3W, $i=1,2,3$: 1P2W(3ch)/3P4W

(3) Reactive electric energy WQ [Varh]

Displayed item	Nothing (Consumption: Data is saved.)	
Equation	Consumption ($+WQ$)	$+WQ = \sqrt{(+WS)^2 - (+WP)^2}$

(4) Time of integration

Displayed item	00:00:00 (hour: minute: second) *varies depending on elapsed time	
Display range	→ 00:00:00 ~ 99:59:59 (99-hour 59-min 59-sec)	
	→ 0100:00 ~ 9999:59 (9999-hour 59-min)	
	→ 010000 ~ 999999 (999999-hour)	

(5) Setting item

Record interval	1/ 2/ 5/ 10/ 15/ 20/ 30sec. 1/ 2/ 5/ 10/ 15/ 20/ 30min. 1 hour
Start/ Stop	By manual operation or specifying start/ stop date and time

* Record interval = Integration interval

13-4 Demand value measurement

(1) Target value (T_{DEM})

Display range	0.1W ~ 999.9GW (set value is fixed)
---------------	-------------------------------------

(2) Predicted value (G_{DEM})

Display range	0 ~ 999999dgt * Decimal position ₁ , unit is same to T_{DEM} .
Equation	$G_{DEM} = \Sigma DEM \times \frac{\text{Demand interval}}{\text{Period from beginning of demand interval}}$

(3) Demand value (present value) (ΣDEM)

Display range	0 ~ 999999dgt * Decimal position ₁ , unit is same to T_{DEM} .
Equation	$\Sigma DEM = \left(+ WP \text{ from beginning of demand interval} \right) \times \frac{1 \text{ hour}}{\text{Demand interval}}$ $\Sigma DEM = \sum \Sigma DEM_i$

* $i = 1$: 1P2W(1ch)

* $i = 1,2$: 1P2W(2ch), 1P3W, 3P3W

* $i = 1,2,3$: 1P2W(3ch), 3P4W

(4) Load factor

Display range	0.00 ~ 9999.99%
Equation	$\frac{\Sigma DEM}{T_{DEM}}$

(5) Setting item

Record interval (Demand interval)	1/ 2/ 5/ 10/ 15/ 20/ 30sec. 1/ 2/ 5/ 10/ 15/ 20/ 30min. 1 hour
Start/ Stop	By manual operation or specifying start/ stop date and time
Demand target value	0.1W ~ 999.9GW
Inspection cycle	Can select one of three preceding time to the set record interval. (e.g. When interval is 30min., select one from 10/ 15/ 20min. when interval is 5min., select one from 30sec/ 1/ 2min. * In case that the record interval is set to one of 1/ 2/ 5sec., setting for inspection cycle is not available. * When $G_{DEM} > T_{DEM}$ is detected at each inspection cycle, buzzer sounds and backlight blinks.

13-5 Other specifications

(1) Communication function

Communication method	USB Ver1.1
Communication speed	19200bps

* Connecting some MODEL6300 (max. 10pcs) in daisy chain via HUB enables individual identification. (Data transmission to PC shall be done one by one.)

* Recommended length of USB cord is 2m or less.

(2) CF card interface

Slots	Type I/ II
Compatibility	32/ 64 /128MB
Format	FAT16
Number of files can be saved	max. 20 files
Saving format	CSV format
File name	<p>▲FILE■■■.csv</p> <p>▲: 1 (instantaneous measurement), 2 (integration measurement), 3 (Demand measurement)</p> <p>■■■ : 001~999 sequence number (given automatically)</p> <p>Number returns to 001 after system reset.</p>

(3) Internal memory

Memory type	EEPROM
Storage capacity	128kB
Number of files can be saved	1 file
File name	<p>▲DATA■■■.csv</p> <p>▲: 1 (instantaneous measurement), 2 (integration measurement), 3 (Demand measurement)</p> <p>■■■ : 001~999 sequence number (given automatically)</p> <p>Number returns to 001 after system reset.</p>

(4) Scaling function

VT ratio	1 ~ 10000 (in 1 increments)
CT ratio	1.00 ~ 10000 (in 0.01 increments)

(5) Other functions

- * Time (clock)
- * Data hold
- * Key lock
- * System rest

13-6 Specification of Clamp sensor

< MODEL8125 >

- Rated current
AC 500A rms (AC 710A peak)
- Output voltage
AC 0 ~ 500mV (AC 500mV/ 500A)
- Measuring range and accuracy (sine wave input)

Measuring range	Frequency range	Accuracy
0 ~ 500 A	50/60Hz	$\pm 0.5\%rdg \pm 0.1mV$
	40Hz ~ 1kHz	$\pm 1.0\%rdg \pm 0.2mV$

- Phase characteristic
within $\pm 1deg$ (10 ~ 500A/ 45~65Hz)
- General specification

Location for use	In door use, Altitude up to 2000m
Temperature & humidity range (guaranteed accuracy)	23°C \pm 5°C/Relative humidity 85% or less (no condensation)
Operating temperature & humidity range	0°C ~ 50°C/Relative humidity 85% or less (no condensation)
Storage temperature & humidity range:	-20°C ~ 60°C/Relative humidity 85% or less (no condensation)
Max allowable input	AC 500A rms continuously (50/60Hz)
Output impedance	approx. 2 Ω
Withstand voltage	AC5320V rms (50/60Hz)/ for 5sec. between jaw matched part and enclosures between enclosures and output terminal between jaw matched part and output terminal
Insulation resistance	50M Ω or more/ 1000V between jaw matched part and enclosures between enclosures and output terminal between jaw matched part and output terminal
Applicable standard	IEC61010-2-032 Measurement CATIII, 600V, Pollution degree 2 IEC61326 (Class A)
Diameter of measured conductor	Max. $\Phi 40mm$
Cable length	About 3m
Output terminal	MINI DIN 6PIN
Outer diameter	128(L) x 81(W) x 36(D) mm
Weight	approx. 260g
Accessories	Instruction manual, Cable maker

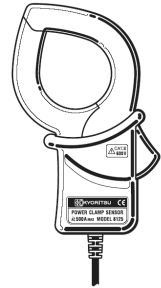

Kyoritsu reserves the rights to change specifications or designs described in this manual without notice and without obligations.



**KYORITSU ELECTRICAL
INSTRUMENTS
WORKS, LTD.**

No.5-20, Nakane 2-chome, Meguro-ku,
Tokyo, 152-0031 Japan
Phone : 81-3-3723-0131 Fax : 81-3-3723-0152
URL : <http://www.kew-ltd.co.jp>
E-mail : info@kew-ltd.co.jp
Factories : Uwajima & Ehime