

## KISTOCK DATALOGGER KCC 320 / KPA 320

Temperature / Humidity / Atmospheric pressure / CO<sub>2</sub>

### KEY POINTS

- Software for configuration and data visualisation freely downloadable
- Software for configuration and data processing available in option
- Safety lock wall mount with inviolability system
- Storage capacity of 2 000 000 points
- Fast data downloading: 18 000 points/s
- Up to 4 recordable parameters simultaneously
- 2 configurable setpoint alarms for each channel
- 2 lines LCD screen
- Bluetooth® communication for smartphones and tablets (Android and IOS)
- Magnetic mounting
- IP 40 protection



### REFERENCES

Device reference	Display	Internal sensor		External sensor		Parameters	Number of record points
		Number	Type	Number	Type		
KCC 320	Yes	4	Temperature, humidity, atmospheric pressure, CO <sub>2</sub>	-		Temperature, humidity, atmospheric pressure, CO <sub>2</sub>	2 000 000
KPA 320		3	Temperature, humidity, atmospheric pressure			Temperature, humidity, atmospheric pressure	

### HOUSING

#### Dimensions

110.2 x 79 x 35.4 mm

#### Weight

KCC 320: 206 g

KPA: 200 g

#### Display

2 lines LCD screen

Dimensions of screen: 49.5 x 45 mm

2 indication LEDs (red and green)

#### Control

1 OK key

1 Selection key

#### Material

Compatible with food industry environment

ABS housing

#### Battery power supply

2 lithium double AA 3.6 V batteries

#### Protection

IP 40

#### PC communication

1 micro-USB input

#### Environmental conditions of use

Air and neutral gases

Hygrometry: in non-condensing condition

Maximum altitude: 2000 m

## TECHNICAL FEATURES

	KCC 320	KPA 320
Units displayed	°C, °F, %RH, hPa, ppm	°C, °F, %RH, hPa
Resolution	0.1°C, 0.1°F, 1 ppm, 0.1%RH, 1 hPa	0.1°C, 0.1°F, 0.1%RH, 1 hPa
External input	Micro-USB female connector	
Input for probe	-	
Internal sensor	Humidity, temperature, atmospheric pressure, CO <sub>2</sub>	Humidity, temperature, atmospheric pressure
Type of sensor	<u>Temperature and humidity</u> : capacitive <u>Atmospheric pressure</u> : piezoresistive <u>CO<sub>2</sub></u> : NDIR	<u>Temperature and humidity</u> : capacitive <u>Atmospheric pressure</u> : piezoresistive
Measuring range	<u>Temperature</u> : from -20 to 70°C <u>Humidity</u> : from 0 to 100%RH <u>Atmospheric pressure</u> : from 800 to 1100 hPa <u>CO<sub>2</sub></u> : from 0 to 5000 ppm	<u>Temperature</u> : from -20 to 70°C <u>Humidity</u> : from 5 to 95%RH <u>Atmospheric pressure</u> : from 800 to 1100 hPa
Accuracies*	<u>Temperature</u> : ±0.4°C from 0 to 50°C ±0.8°C below 0°C or above 50°C  <u>Humidity**</u> : ±2%RH from 5 to 95%, 15 to 25°C  <u>Atm. pressure</u> : ±3 hPa  <u>CO<sub>2</sub></u> : ±50 ppm ±3% of the reading	<u>Temperature</u> : ±0.4°C from 0 to 50°C ±0.8°C below 0°C or above 50°C  <u>Humidity**</u> : ±2%RH from 5 to 95%, 15 to 25°C  <u>Atm. pressure</u> : ±3 hPa
Setpoints alarms	2 setpoints alarms on each channel	
Frequency of measurements	From 1 minute to 24 hours (15 s in on-line mode)	From 1 second to 24 hours
Operating temperature	From 0 to +50°C	
Storage temperature	From -40 to +85°C	
Battery life	3 years***	7 years***
European directives	2011/65/EU RoHS II; 2012/19/EU WEEE; 2014/30/EU EMC; 2014/35/EU	

\* All accuracies indicated in this document were stated in laboratory conditions and can be guaranteed for measurement carried out in the same conditions, or carried out with calibration compensation.

\*\* Factory calibration uncertainty: ±0.88%RH. Temperature dependence: ±0.04 x (T-20) %RH (if T≤15°C or T≥25°C)

\*\*\* On the basis of 1 measurement each 15 minutes at 25°C.

## RECORDER FUNCTION

### 5 recording modes

KISTOCK can record in 5 different ways :

- **"Immediate"** mode records values according to a predefined interval.
- **"Minimum"**, **"Maximum"** and **"Average"** record automatically the calculation of minimum, maximum or average of measured values during an interval of recording.
- **"Monitoring"** mode allows to get an accurate history report during error events to help troubleshooting, without stopping the measurement logging. To proceed this way, you just have to define :
  - a record interval to be used whilst the readings are beyond the setpoints.
  - a record interval for the values measured during each reading beyond the setpoints.
 Furthermore, you can also let your KISTOCK record non-stop ("**loop**" recording option).

### 4 types of dataset start

Once your recording mode has been set, you can launch your dataset :

- With a delayed start (with predefined date and time)
- With the software
- With push-button
- With **"Online"** option. In this case, your datasets are directly sent, saved and displayed on your PC in real time.

### 6 types of dataset stop

You can stop your dataset :

- According to a date and time (if it was started the same way)
- According to a period
- According to a predefined number of recording points
- Once the storage capacity is full
- With **"Stop"** option of the software
- By holding **"OK"** key during 5 seconds, if this function has been previously activated by the software

## DIMENSIONS (mm)

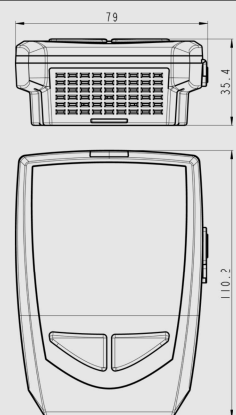

## PC CONNECTION



## DISPLAY

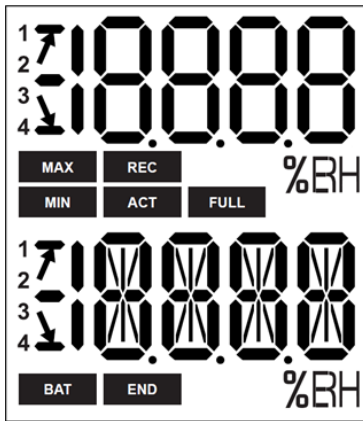

**END** DATASET is finished.

**REC** Indicates that one value is being recorded.  
It flashes: the DATASET did not start already.

**FULL** Flashing slowly: DATASET is between 80 and 90 % of the storage capacity.  
Flashing quickly: DATASET is between 90 and 100 % of the storage capacity.  
Constant: storage capacity full.

**BAT** Constant: indicates that the batteries have to be replaced.

**ACT** Screen actualisation of measured values.

**MIN**  
**MAX** The displayed values are the maximum/minimum values recorded for the channels displayed.

 Indicates the alarm action type: rising or falling action.

 Temperature in °Celsius.

 Temperature in °Fahrenheit .

 Relative humidity.

1  
2 Indicates the channel number which is measuring.  
3  
4

## SOFTWARE



- **KILOG LITE:** free software to download on the KIMO website (kimo.fr). Allows the data download (graphics and points statement) and the datalogger configuration.



- **Configuration and data processing software**  
**KILOG** software allows to configure, save and process your data in a very simple way.
- Software only: Ref. **KILOG-3-N**
- Complete set: software + 1 USB cable, Ref. **KIC-3-N**

## SAFETY LOCK WALL MOUNT WITH PADLOCK



➤ Mount the safety lock support on the required place.

1. Present the KISTOCK datalogger on the support **starting with the inferior part**
2. Clip the KISTOCK on the support by falling back the superior part
3. Insert the padlock to ensure the safety lock function

 The padlock can be replaced by a fail-safe sealed

 The datalogger can be placed on the screw-mount without the safety lock function

➤ To remove the datalogger from the support, proceed on reverse order.

## MOUNTING

The KISTOCK class 320 have a magnetic mounting, so you can fix it easily.

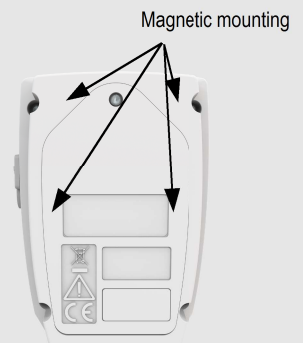

## DIMENSIONS OF THE WALL MOUNT (in mm)



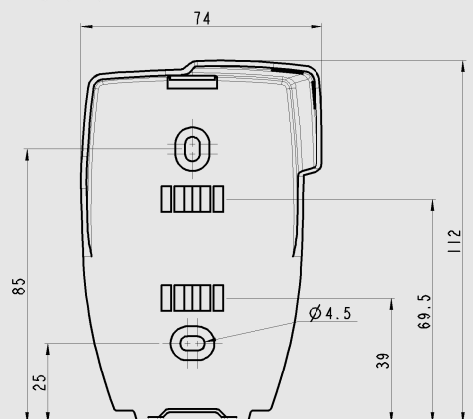

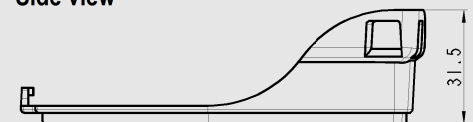

### Front view



### Side view



## ACCESSORIES

Accessories	Part numbers	Illustrations
1 AA lithium 3.6 V battery (  2 batteries are required for class 320 dataloggers)	KBL-AA	
Safety lock wall mount with padlock	KAV-320	
<b>Wired extension for class 320 KISTOCK probes</b> In polyurethane, 5 m length with male and female mini-DIN connectors <u>Note:</u> several extensions can be wired in order to obtain up to 25 m cable length	KRB-320	
<b>Data collector</b> Collects up to 20 000 000 points from one or several KISTOCK directly on-site. Results restitution on PC of realised datasets	KNT-320	
<b>USB micro-USB cable</b> which allows to plug your KISTOCK datalogger to your PC	CK-50	
<b>Neck size hand strap</b>	KDC	



**Only the accessories supplied with the device must be used.**

### CALIBRATION

A calibration certificate is available as option in paper format.  
We recommend to carry out a yearly checking.

### MAINTENANCE

Please avoid any aggressive solvent.  
Please protect the device and probes from any cleaning produce containing formalin, that may be used for cleaning rooms and ducts.

### GUARANTEE PERIOD

KISTOCK dataloggers have 1-year guarantee for any manufacturing defect (return to our After-sales service required).

### PRECAUTIONS FOR USE

Please always use the device in accordance with its intended use and within parameters described in the technical features in order not to compromise the protection ensured by the device.

### REPLACE THE BATTERIES



With 3 to 7 years\* of battery life, the KISTOCK devices guarantee long-term measurements.

#### To replace the batteries:

- > Unscrew the screw on the back side of the KISTOCK, on the battery hatch, with a cross-headed screwdriver.
- > Remove the hatch and the old batteries.
- > Insert the new batteries and respect the polarity.
- > Replace the battery hatch and screw it.

\* On the basis of 1 measurement each 15 minutes at 25°C.



**BE CAREFUL! Material damages can happen, so please apply the precautionary measures indicated.**

 Once returned to KIMO, required waste collection will be assured in the respect of the environment in accordance to guidelines relating to WEEE.

[www.kimo.fr](http://www.kimo.fr)

Distributed by :



**EXPORT DEPARTMENT**

Tel : + 33. 1. 60. 06. 69. 25 - Fax : + 33. 1. 60. 06. 69. 29

e-mail : [export@kimo.fr](mailto:export@kimo.fr)