

Recovery Unit Manual

VRR12L-R32 / VRR24L-R32
VRR12LOS-R32 / VRR24LOS-R32



TABLE OF CONTENT

General Safety.....	1
Operation Manual.....	3
Specification.....	5
Introduction of Operation Panel.....	6
Parts Diagram.....	7
Wiring Diagram.....	8
VRR12L(OS)-R32 / VRR24L(OS)-R32 Operating Instruction	
1). Refrigerant pipes' exhaust.....	9
2). Recovery Method.....	10
3). Self-purge Method.....	11
4). Liquid Push/Pull Method.....	12
Trouble Shooting.....	13

GENERAL SAFETY

Use information

- In order to prolong the usage of the recovery unit, please read the operating manual carefully before using, which can help you to fully understand the safety, specification as well as operating procedure of the recovery unit.
- Please check the product received is same as you ordered and also the accessories operating manual are attached. Please check the product if there is any damage during transportation. Contact with local distributor if the above problem is found.
- Please read the operating manual carefully and use the unit according to the product operating procedures.

Safety indication

Warning

Indicates procedures that must be strictly observed to prevent hazards to persons.

Notice

Indicates procedures must be strictly observed to prevent damage or destruction of the unit.

Matters needing attention

Warning

Only a qualified technician can operate this recovery unit.

Before starting the equipment, make sure that it is well grounded.

While using electrical wire, the wire must be well connected and grounded.

Only a qualified electrician can do the wire connection according to the technical standard and circuit diagram.

Be sure the power is off before examining or repairing the recovery unit.

If the original power supply cord is damaged, choose carefully for the replacing one, or you may directly buy from us.

When the unit breaks down, be sure the power is off before you do any operation.

GENERAL SAFETY

Please take power supply and the capacity of your ammeter and electrical wire.

Only authorized refillable refrigerant tanks can be used. It requires the use of recovery tanks with a minimum working pressure of 45 bar(652.6 psi). Do not overfill the recovery tank, maximum at 80% capacity to make sure that there is enough space for liquid expansion. Overfilling of the tank may cause a violent explosion.

Always wear safety goggles and protective gloves while working with refrigerants to protect your skin and eye from hurting by refrigerant gases or liquid.

Do not use this equipment near flammable liquid or gasoline.

An electric scale is needed to prevent overfilling.

Be sure that the place where you are working is thoroughly ventilated.

Notice

Be sure the unit is working under the right power supply.

When using an extension cord it should be minimum 2.0mm² AWG and no longer than 2.5 m, otherwise it may cause the voltage drop and damage the compressor.

The input pressure of the unit should not exceed 26bar(377.1psi).

The unit need to be laid in horizontally, otherwise it will lead to unexpected vibration, noise or even abrasion.

Do not expose the equipment to sun or rain.

The ventilation opening of the unit must not be blocked.

If the overload protector pops, reposition it after 5 minutes.

If this equipment is equipped with oil separator device only during vapor recovery process it will purification and recycling of the refrigerants.

When the recovery vapor over 8 kg it need to release the oil of oil separator device.

(While release oil the internal system must be without pressure)

OPERATION MANUAL

1. Do not mix different refrigerants together in one tank, or they could not be separated or used.
2. Before recovering the refrigerant, the tank should achieve the vacuum level: -75cmHg(-29.6psi), which is for purging non-condensable gases. Each tank was full of nitrogen when it was manufactured in the factory, thus the nitrogen should be evacuated before the first use.
3. The switch should be at "0" Position before operation. All the valves must be closed, the input and output fittings should be covered with protective caps when the unit is not in operation. The air moisture is harmful to the recovery result and will shorten the life span of the unit.
4. A filter drier should always be used and should be replaced frequently. And each type of refrigerant must have its own filter. For the sake of ensuring the normal operation of the unit, please use the filter specified by our company. High quality filter drier will bring high quality services.
5. Special-caution is needed when recovering from burnt system, and two dry filter is needed.
6. The unit has an Internal High Pressure Shut-Off switch. If the pressure inside the system is above rated shut-off pressure (see specification), compressor will automatically shut off and the high pressure alarm light will turn on. To restart the compressor, please lower the internal pressure (Output gauge indicates lower than 30 bar/435.1 PSI), after the high pressure alarm light turn off, hit the Reset button, then turn on the power to restart the compressor.
When high pressure protection is initiated, please find out the cause and deal with it before restarting the unit. Cause of High Pressure Protection and Trouble Shooting:
 - ① The input valve of the refrigerant tank is closed——open the valve will help solve the problem.
 - ② The connecting hose between the recovery unit and refrigerant tank is stuck——close all the valves and replace the connecting hose.
 - ③ The temperature of the refrigerant tank is too high, pressure is too high——give it some time to cool down and the pressure will come back to normal.
7. This unit can be used together with a float level sensor. Please connect the recovery unit and the tank with the 80% O.F.P. Cable. If the liquid refrigerant reaches 80% capacity of the tank the recovery unit will automatically shut off and the Red Alarm Light turns on. Before restart please change a new tank.
8. Please press "ϕ" button when start or stop running the machine.

The "ϕ" light is on when compressor works.

OPERATION MANUAL

9. If the refrigerant tank has no float level sensor, please take the 80% O.F.P Cable off. Otherwise the recovery unit can not started. In this case, an electric scale is required to monitor the recovered refrigerant amount.
10. In order to gain maximum recover speed, a hose with inner diameter bigger than 4mm is recommended and the hose should better be shorter than 1.5m.
11. While recovering large amounts of liquid, use the Push/Pull Mode.
12. After recovering, make sure there is no refrigerant left in the unit. Read the Purge Operation carefully. Liquid refrigerant remained in the unit may be expanded and destroy the components.
13. If the unit is to be stored or not used for any length of time, we recommend that it be completely evacuated of any residual refrigerant and purged with dry nitrogen.
14. Connection hose with check valve is recommended, it can prevent refrigerant lose.
15. The intake port is equipped with filter screen, please wash it frequently to keep it clean.
16. The Low Pressure Gauge shows the pressure of the intake port of the compressor and the High Pressure Gauge shows the pressure of the outlet port of the recovery unit.
17. After using , please ture the knob to "0" position.

SPECIFICATION

	VRR12L-R32	VRR24L-R32
Refrigerants	Category III: R12, R134a, R401C, R406A, R500, 1234YF Category IV: R22, R401A, R401B, R402B, R407C, R407D, R408A, R409A, R411A, R411B, R412A, R502, R509 Category V: R402A, R404A, R407A, R407B, R410A, R507, R32	
Power	110V~120V / 60Hz; 220V~240V / 50~60Hz	
Motor	3/4 HP	1 HP
Motor Speed	1450 RPM@50Hz / 1750 RPM@60Hz	
Maximal Current Draw	110V: 8A; 220V:4A	110V: 10A; 220V: 5A
Compressor	Oil-less, Air-cooled, Piston	
High Pressure Shut-off	38.5bar/3850kPa(558psi)	
Operating Temperature	0°C ~40°C / 32~104°F	
Dimensions	OS Without	400mm×250mm×355mm
	OS With	450mm×250mm×355mm
Net Weight	OS Without	13.5 kg
	OS With	14.7 kg

VRR12L-R32

Refrigerants	R134a	R22	R410A
Liquid	1.60kg/min	1.80kg/min	2.20kg/min
Push/Pull	4.60kg/min	5.60kg/min	6.30kg/min

VRR24L-R32

Refrigerants	R134a	R22	R410A
Liquid	3.00kg/min	3.50kg/min	3.50kg/min
Push/Pull	7.50kg/min	8.50kg/min	9.50kg/min

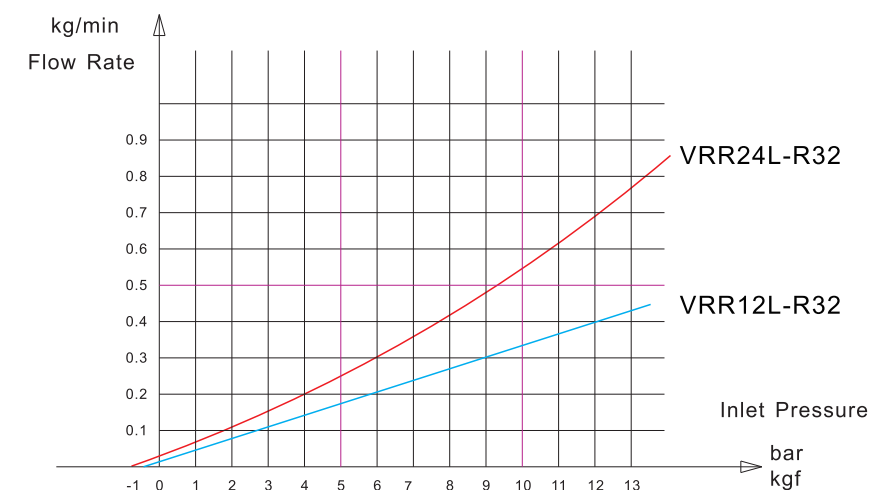

▲ Notice
The flow rate of vapor is direct proportion to inlet pressure.

INTRODUCTION OF OPERATION PANEL

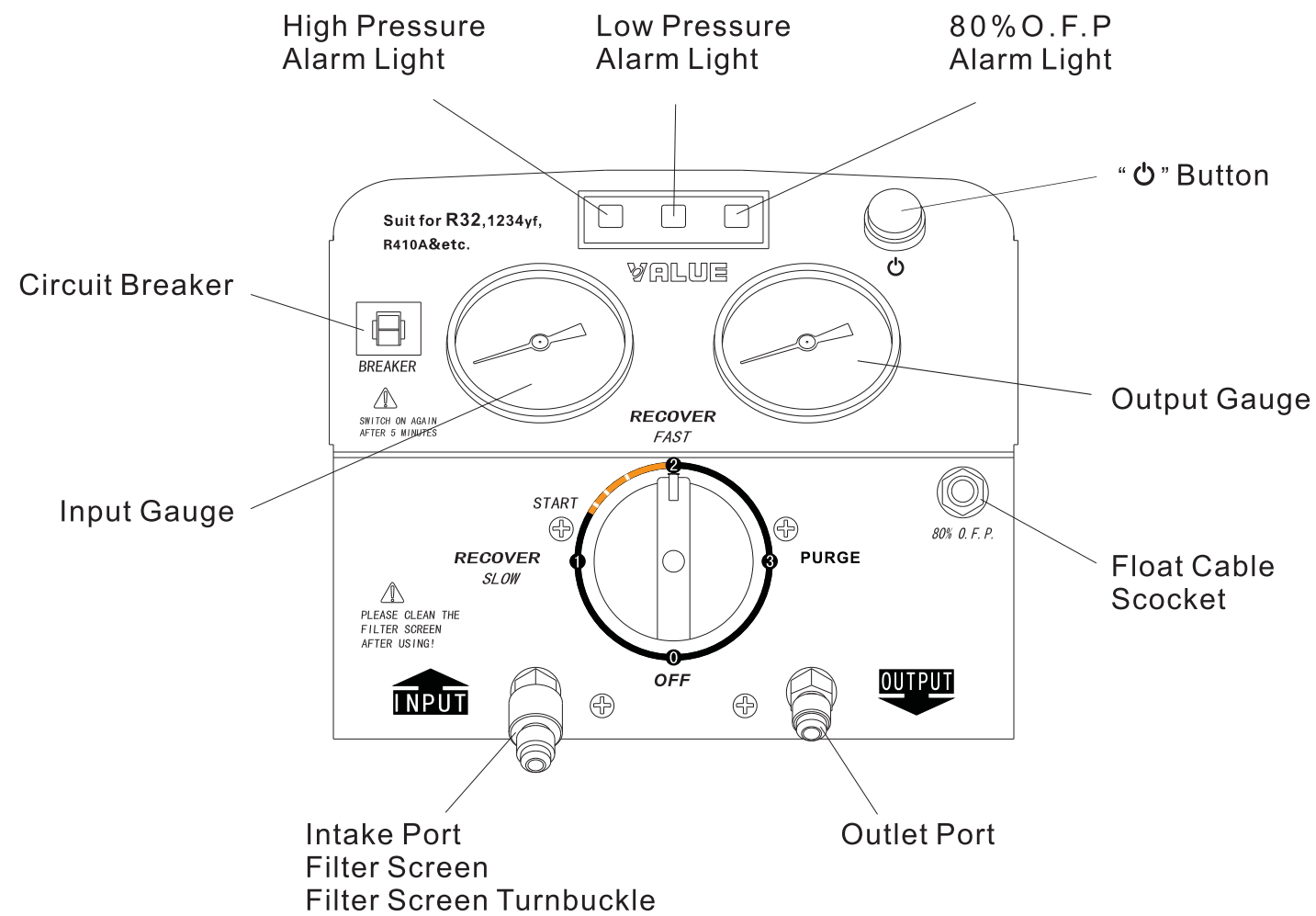

PARTS DIAGRAM

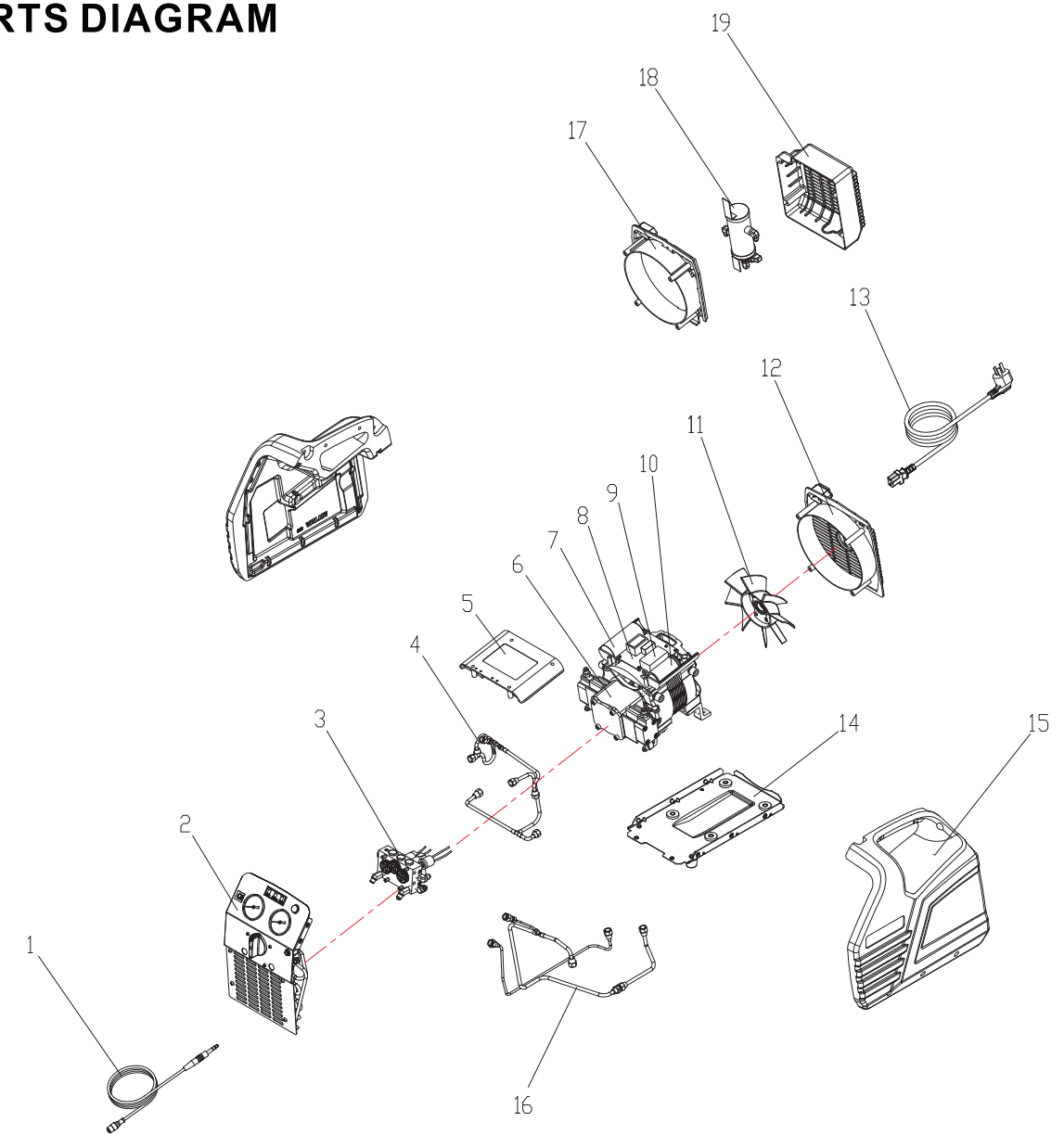

NO.	Component	NO.	Component
1	O.F.P.Cable	11	Fan
2	Front Panel	12	Fan Cover
3	Control Valve	13	Power Supply Cord
4	Copper Pipes ■	14	Base
5	Junction Box Cover	15	Cover
6	Compressor ■	16	Copper Pipes ■ ▲
7	Running Capacitor	17	Oil Separator Fan ▲
8	Circuit Board	18	Oil Separator ▲
9	Electronic Starter	19	Oil Separator Back Cover ▲
10	Starting Capacitor	20	

■ : VRR12L(OS)-R32 / VRR24L(OS)-R32 According To The Model Configuration

▲ : Oil Separator Designed With

WIRING DIAGRAM

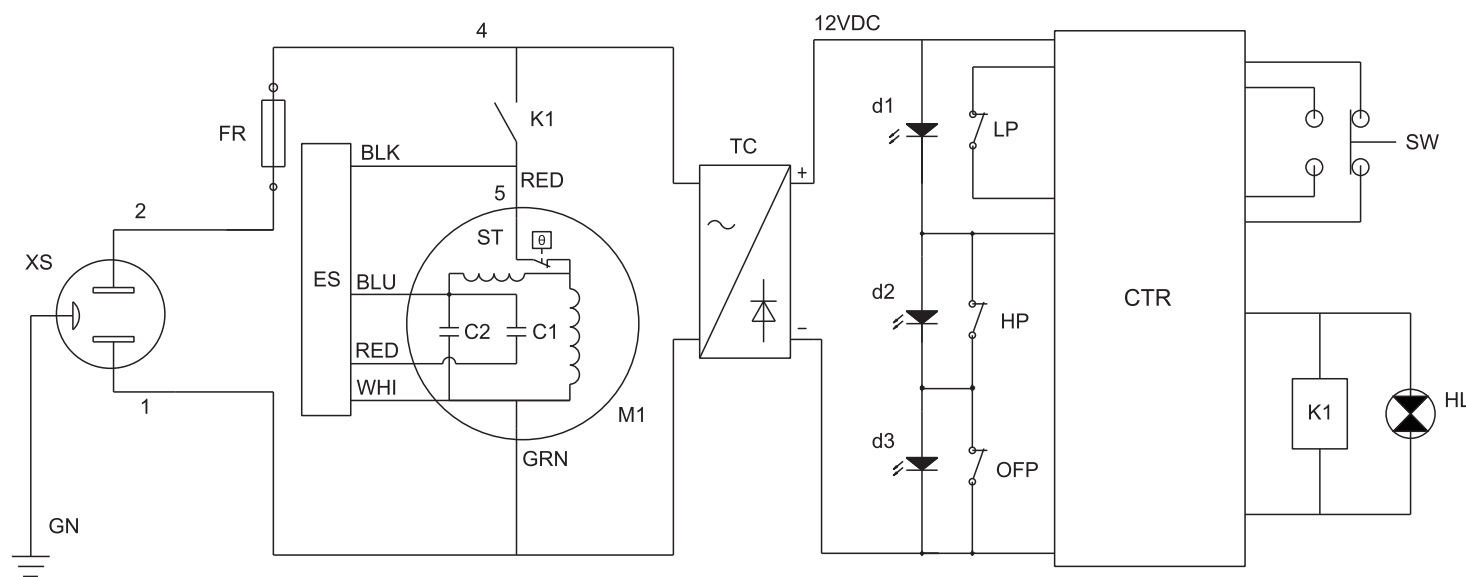

NO.	Graphics Code	Component	NO.	Graphics Code	Component
1	XS	Power Outlet	10	LP	Low Pressure Switch
2	FR	Overload Protection Device	11	OFF	80%O. F. P. Switch
3	ES	Electronic Starter	12	d1	Green Indicator
4	M1	Compressor Motor	13	d2、d3	Red Indicator
5	C1	Start Capacitor	14	SW	Power Button
6	C2	Running Capacitor	15	HL	Indicating Lamp
7	ST	Motor Thermal Protectors	16	CTR	Control Module
8	TC	Electronic Transformer	17	K1	Relay
9	HP	High Pressure Switch	18		

VRR12L(OS)-R32 / VRR24L(OS)-R32 OPERATING INSTRUCTION

1). Refrigerant pipes' exhaust

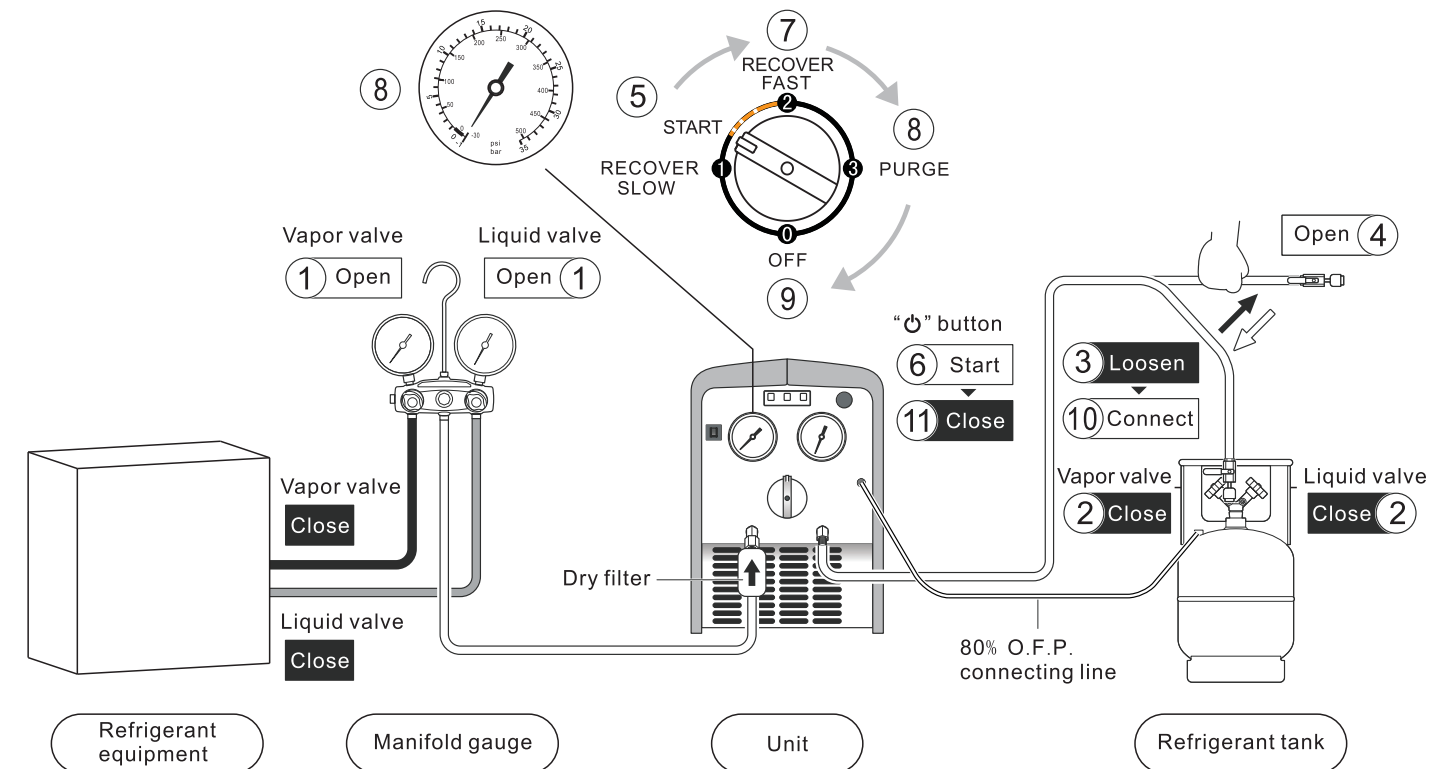

Ready for operation

※Connect the pipes correctly and firmly.

(Please refer to the connection diagram)

1. Open the vapor and liquid valves of manifold gauge.
2. Close the vapor and liquid valves of tank.
3. Loosen the connecting pipes of refrigerant tank.
4. Open the valve of pipes.

Start operation

5. Turn the switch to position "START".
6. Press "Start" button.
7. Turn the switch to position "2" and start exhausting the air of inside pipes.

8. While the input gauge getting to -1bar, turn the switch to position "3" to start self-purge.

9. While the input gauge getting to -1bar again, turn the switch to position "0" to finish self-purge.

10. Connect the pipes to refrigerant tank.

Finish operation

11. Press "Close" button.

VRR12L(OS)-R32 / VRR24L(OS)-R32 OPERATING INSTRUCTION

2). Recovery mode

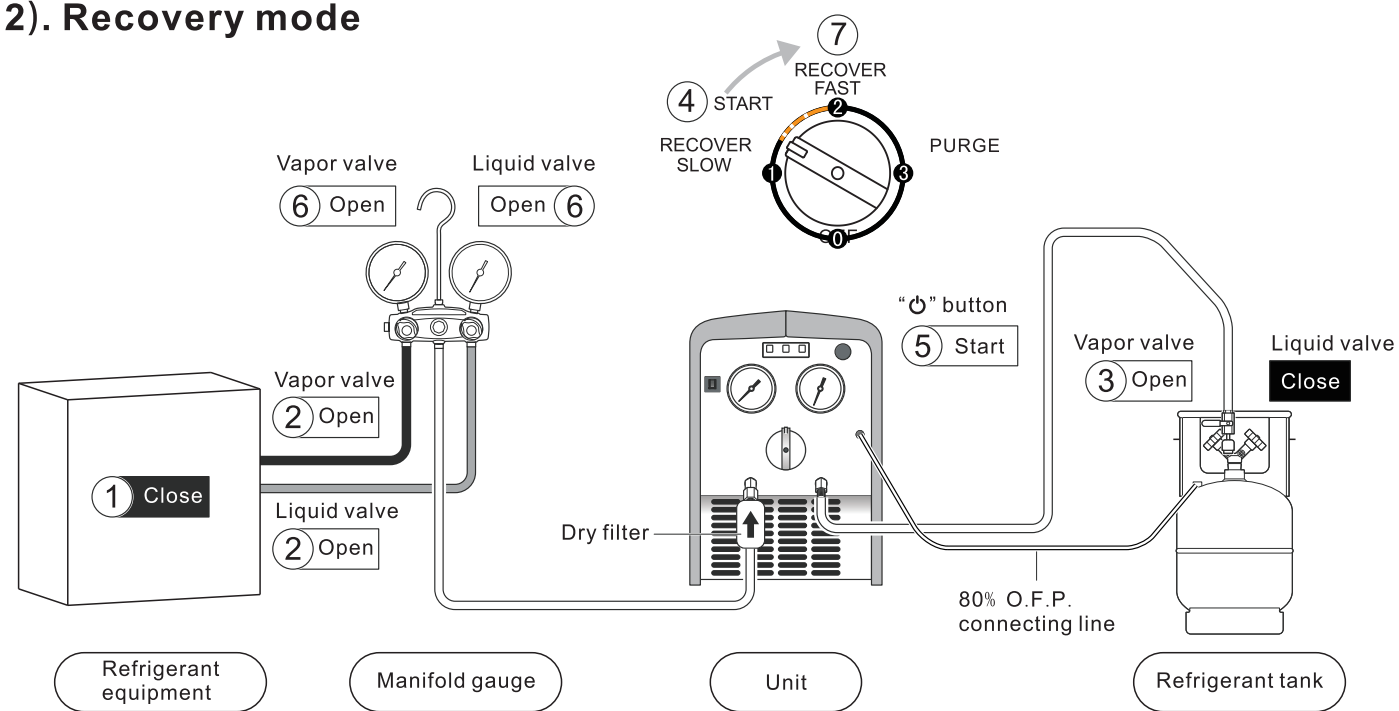

Ready for operation

※Connect the pipes correctly and firmly.

(Please refer to the connection diagram)

※Make sure all valves are closed.

1. Switch off the power of refrigerant equipment.
2. Open the vapor and liquid valves of refrigerant equipment.
3. Open the vapor valve of the refrigerant tank.

Start operation

4. Turn the switch to the position "START".
5. Press "Start" button.
6. a. Open the liquid valve for liquid recovery.
b. Open the vapor valve for vapor recovery.
7. Turn the switch slowly to position "2" for faster recovery.
8. When the recovery is finished, the unit gets the needed vacuum or automatically stop with low pressure protection.

▲ Notice

- ① If compressor impact occurs at the position "2", turn the switch to position "START" until the impact stops.
- ② If the recovery restarts after interruption of power or difficult to start,
 - a. Turn the switch to position "START", turn on the power switch, press start button for liquid recovery.
 - b. Turn the switch to position "3", turn on the power switch, press start button for vapor recovery.

▲ Notice

- ① Turning the switch to position "1" gets a stable recovery of liquid with low speed of 1.2Kg/Min.
- ② If compressor impact occurs at the position "1", turn the switch slowly to position "START" until the impact stops. Make sure the pressure is not at 0, because it doesn't work at 0.

※ There is no need to turn off the power and it can do the self-purge work directly.

VRR12L(OS)-R32 / VRR24L(OS)-R32 OPERATING INSTRUCTION

3). Self-purge mode

▲ Notice

The unit must be purged after each use;
Liquid refrigerant remained may expand and damage the components and pollute the environment.

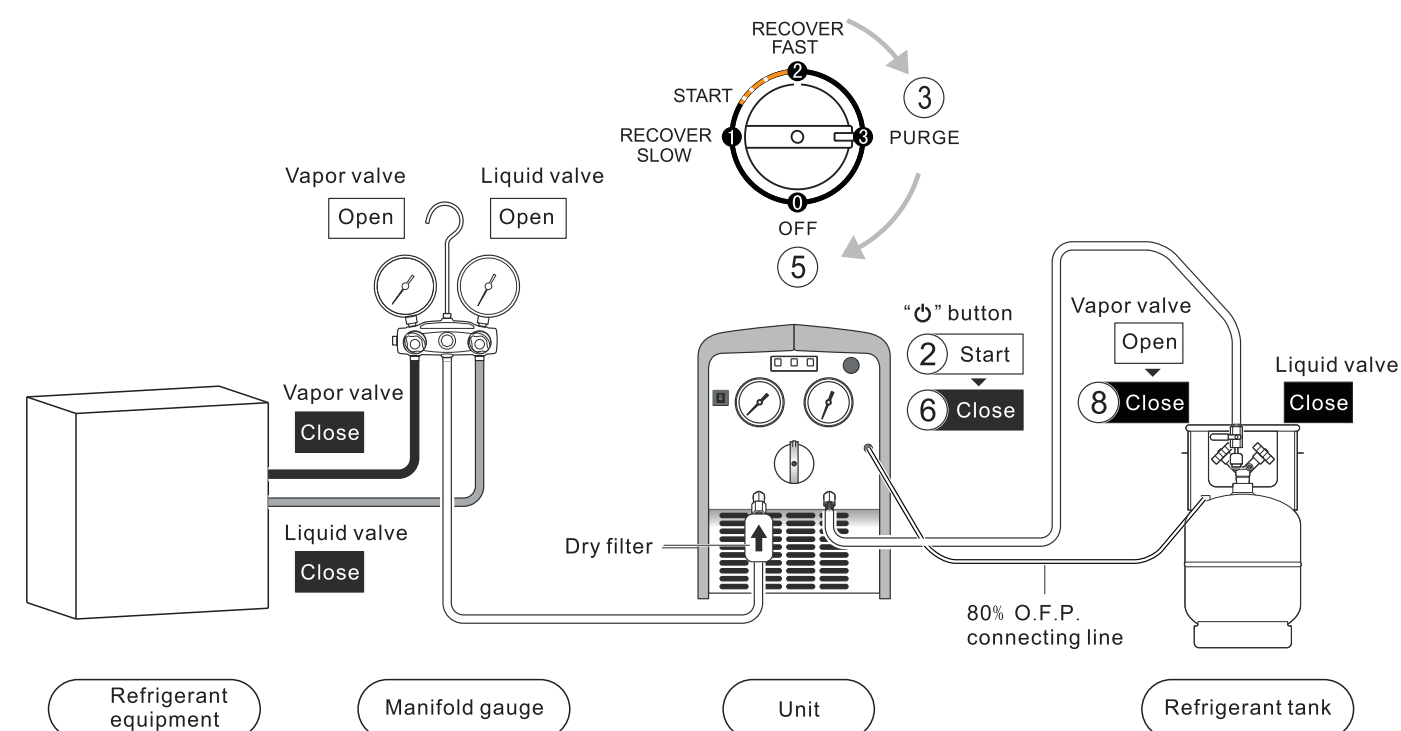

Ready for operation

1. The unit stops automatically when finish recovery,
2. Press "Start" button.
3. Turn the switch slowly to position "3" to start purge.
4. When the self purging is finished, the unit gets needed vacuum.

Finish operation

5. Turn the switch to position "0".
6. Press "Start" button.
7. Close the check valve of pipes.
8. Turn off the vapor valve of refrigerant tank.

VRR12L(OS)-R32 / VRR24L(OS)-R32 OPERATING INSTRUCTION

4). Liquid push/pull mode

▲ Notice

An electric scale is needed to monitor the recover process to prevent overfilling.

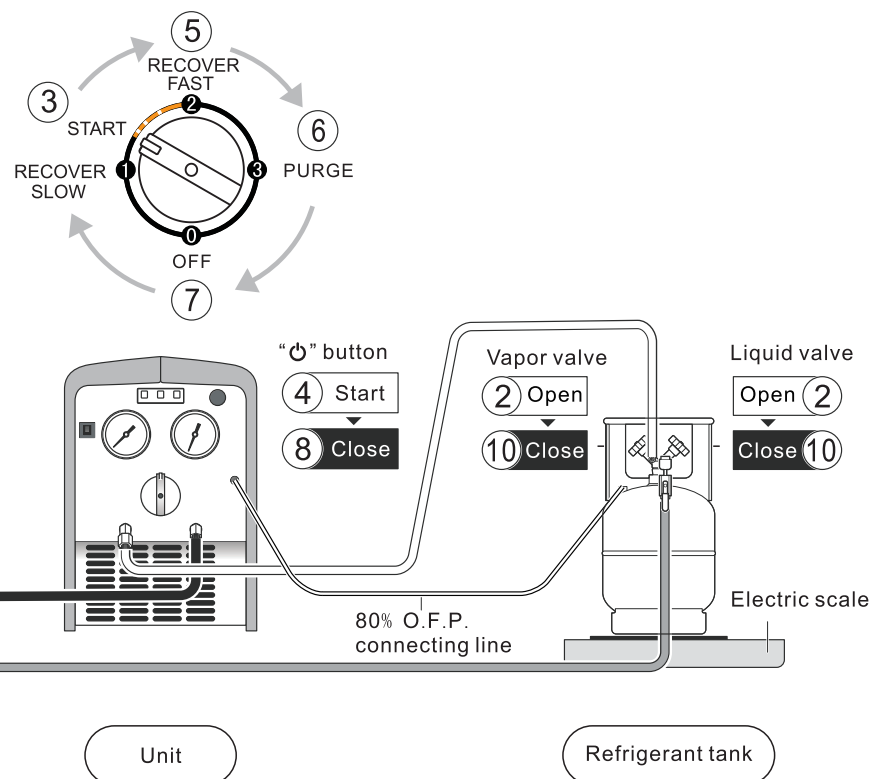

Ready for operation

- ※Connect the pipes correctly and firmly.
(Please refer to the connection diagram)
- ※Make sure all valves are closed.

Start operation

1. Open the vapor and liquid valves of refrigerant equipment.
2. Open the vapor and liquid valves of the refrigerant tank.
3. Turn the switch to position "START".
4. Press "φ" button.
5. Turn the switch to position "2" to start push/pull mode.

- ※When the display of electric scale remains unchanged or changes very slowly, it means the liquid recovery is finished, and it is time for vapor recovery.

6. Turn the switch to position "PURGE" and follow self-purge mode to purge the gas refrigerant.
7. Turn the switch to position "OFF".
8. Press "φ" button.
9. Close the vapor and liquid valves of refrigerant equipment.
10. Close the vapor and liquid valves of refrigerant tank.
11. Connect the pipes again and recover the vapor of refrigerant equipment according to recovery mode.

Finish operation

▲ Warning

When the showing of the electric scale show that the refrigerant in the tank reaches 80% capacity, please turn the power off and close the valves of the tank.

TROUBLE SHOOTING

FAULT	CAUSE	SOLUTION
Fan no response	Mechanical damage	1. Replace the fan 2. Factory service required
Compressor not start (Jammed)	1. External pressure is too high 2. Motor failure or other components damaged	1. a. When recover the liquid, turn the knob to "START" position, then restart b. When recover the vapor, turn the knob to "PURGE" / "3" position, then restart 2. a. Replace the components b. Factory service is needed
Press the "φ" button but compressor no response	1. a. Shut off by high pressure protection, red alarm light turns on. b. Low pressure protection, green alarm light turns on (recovery not finished) c. 80% O.F.P. cable not well connected with tank. 2. The "φ" light is not bright, Internal wiring fault.	1. a. Lower the pressure of the unit b. Check if the hoses are well connected c. Check the connection. 2. a. Be checked by qualified technician b. Factory service required
Compressor start but stops within a few minutes	1. High pressure shut off due to wrong operation, such as: Outlet valve not open, Refrigerant tank valve not open 2. Motor thermal protector shuts off 3. Circuit breaker shuts off 4. a. 80% over filling protection, red alarm light turns on b. Recovery is over and the unit is under low pressure protection, green alarm light turns light c. Overload during liquid recovery, red alarm light goes out after a flash	1. Read carefully the Operation Manual and follow the instructions while operating 2. The compressor will restart automatically after a few minutes 3. Cooling the Circuit breaker down and press "circuit breaker" to restart after 5 minutes 4. a. Replace with an empty recovery tank b. Refer to step of self-purge method c. Turn the knob to "START" position, then restart
Low recovery speed	1. The pressure of the refrigerant tank is too high 2. Piston ring of the compressor is damaged	1. Cool the tank down can help bringing down the pressure 2. a. Replace the components b. Factory service required
Unit doesn't pull out a vacuum	1. Connecting hoses are loose 2. Leakage in the unit	1. Tighten the hose connections 2. a. Replace the components b. Factory service required