

EML Accessory Operating Instructions

Part number: 790-1082

Issue: 1.0 - 3/14

Copyright 2013 by The Charles Machine Works, Inc.

Receiver Controls and Display

Receiver key functions and information displayed will be specific to the EML accessory.



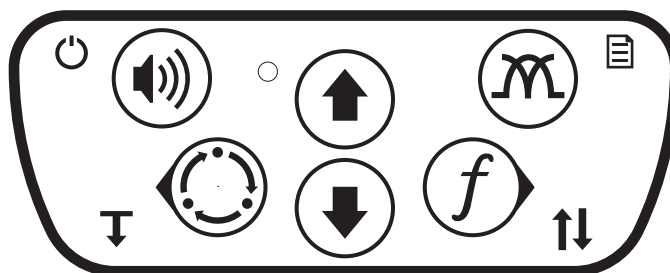









Receiver Keypad



e18om007h.eps

To activate most functions, press and release the button. For other functions, press and hold the button until the function activates.







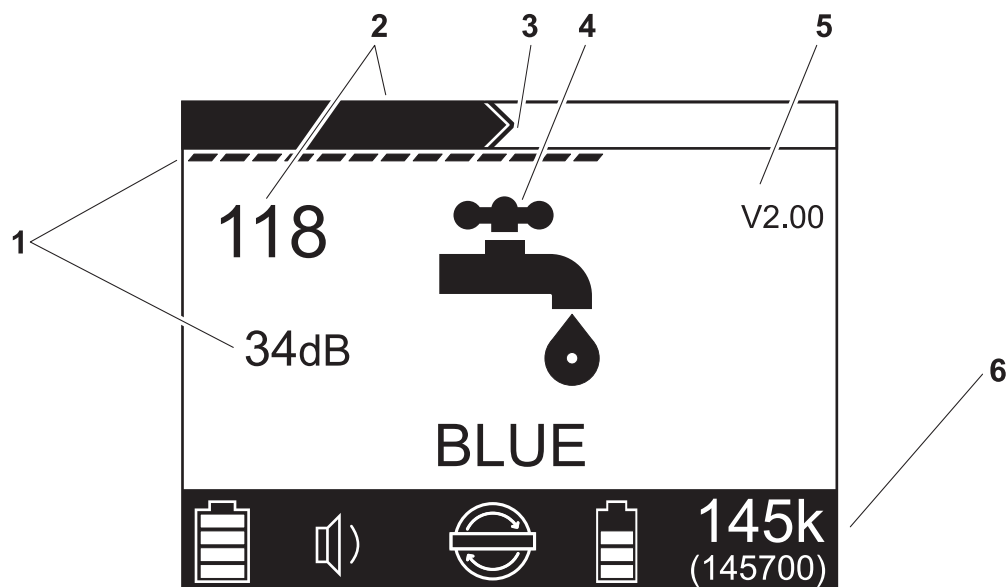



Receiver Keypad Icons

	Power ON/OFF (press and hold)		Up		not used
	Volume		Down		not used
	Mode selector		Frequency		not used
	not used		not used		not used
	not used				

Receiver Display



- | | |
|--------------------|--------------------------------------|
| 1. Gain | 4. Marker ball indicator (see below) |
| 2. Signal strength | 5. EML accessory software version |
| 3. Peak signal | 6. Unit status bar (see below) |

Status Bar Icons	Marker Ball Indicators
 Receiver battery level	 Water (blue, 145k) Non-potable water (purple, 66.3k)
 Volume level	 Power (red, 169k, non-EU only) Power (red/blue, 134k, EU only)
 EML normal mode indicator	 Waste water (green, 121k)
 EML search mode indicator	 Communications (black/orange, 77.0k)
 EML accessory battery level	 Phone (orange, 101k)
selected frequency	 Gas (yellow, 83.0k)

Locate Markers

Locate Markers

Setup

1. Place receiver wand into recess of the EML accessory.
2. Insert strap (1) through buckle (2).
3. Tighten strap using buckle ratchet (3).

IMPORTANT: Do not overtighten.

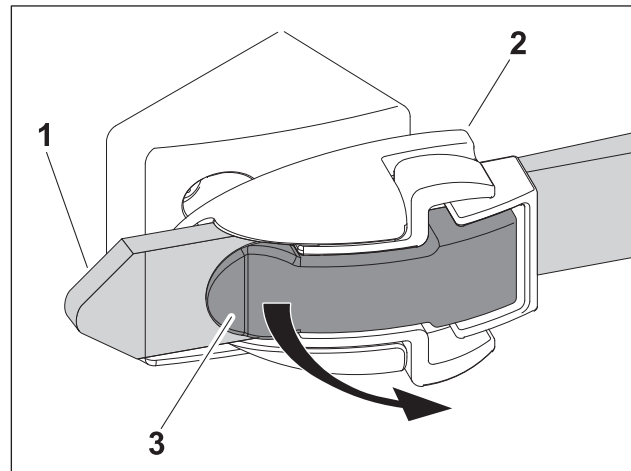

e18om073h.eps

4. Plug cable into receiver accessory connector (shown) behind spring-loaded door.
5. Turn receiver on. The receiver will enter EML Mode automatically and remain in EML Mode as long as EML accessory is plugged in and has sufficient battery power.

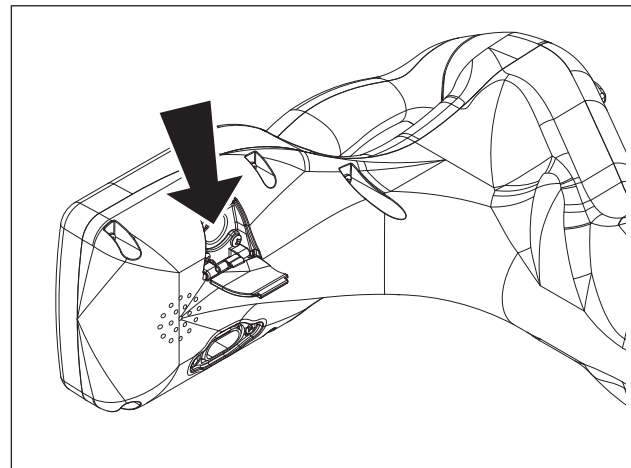

e18om076h.eps

To release:

1. Disconnect the EML cable from the receiver.
2. Place EML accessory on solid surface (ground, tailgate, etc.) and hold receiver wand (2) with left hand while pushing both levers (1) toward EML accessory with the right hand.
3. When buckle clicks, continue pressing levers and twist receiver to loosen strap enough to remove wand.

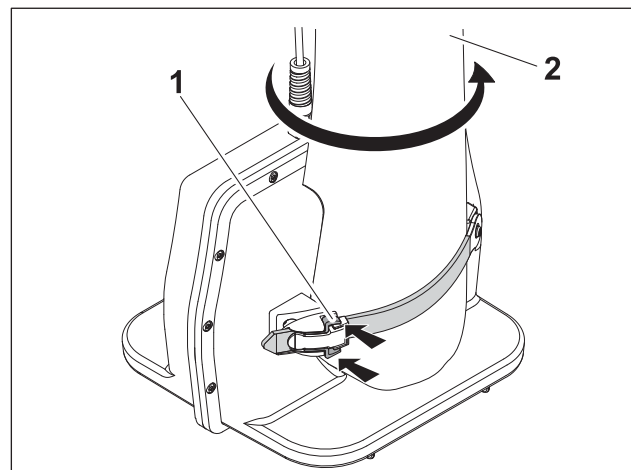

e18om072h.eps

Technique

Normal Marker Locating Mode

1. Attach EML accessory to the receiver.
2. Plug the EML cable into the receiver accessory connector.
3. Select marker type using the Frequency key.

IMPORTANT: Test unit for proper operation by passing the wand 3' (1 m) over a marker. Signal strength should increase and the bar graph should close.

4. Walk over area where you suspect a marker has been buried. Hold EML accessory close to the ground and move it from side to side. Move in the direction of increasing signal strength. Adjust gain as needed. Marker is located where receiver indicates maximum signal.
5. To locate next marker, adjust gain to 30 dB and repeat process.

Search Mode

If unsure about what markers are in the area, use Search Mode to locate all frequencies. After scanning for each frequency separately, the receiver displays the location information for the marker with the highest signal. Up and Down keys will adjust gain in this mode.

Change Batteries

Change Batteries

Use ten AA-cell alkaline batteries in transmitter.



WARNING Battery cells inside may vent or rupture. Do not crush, do not heat or incinerate, do not short circuit, do not dismantle, do not immerse in any liquid. Observe charging instructions.

To help avoid injury, see battery manufacturer's safety instructions.

1. Open battery cover.
2. Remove battery holder.
3. Insert batteries in holder as shown.

IMPORTANT:

- Installing batteries backwards will cause damage to batteries and unit.
- Do not mix new and used batteries.

4. Place battery holder in battery compartment.
5. Close and tighten battery cover.

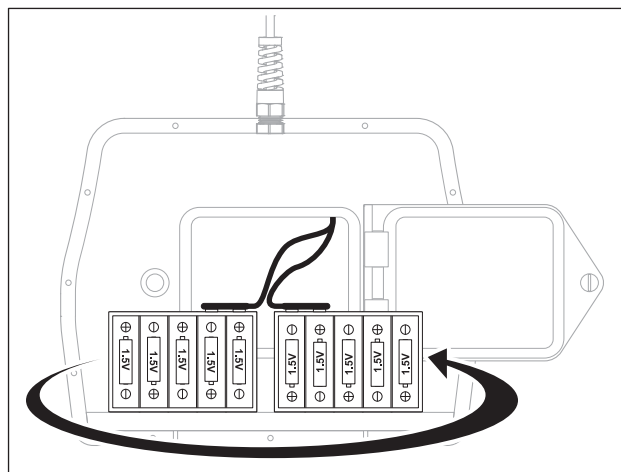

e18om069h.eps

Specifications

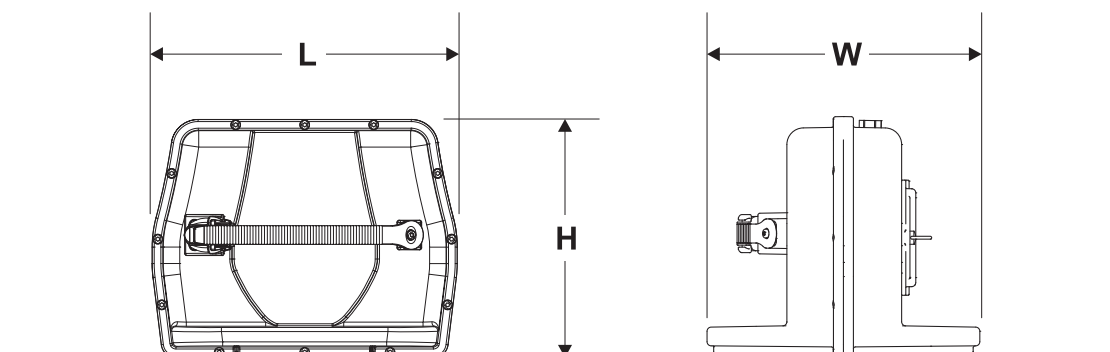

e13om067h.eps

Dimensions	U.S.	Metric
L, length	9.3 in	236 mm
H, height	7.3 in	185 mm
W, width	8.2 in	208 mm
Weight, without batteries	2.5 lb	1.2 kg
Weight, with batteries	3.0 lb	1.4 kg
Operational		
Marker frequencies: 66.35 kHz (non-potable water), 77.0 kHz (cable television), 83.0 kHz (gas), 101.4 kHz (telephone), 121.6 kHz (sewer); 134.0 kHz (electric power - EU countries); 145.7 kHz (water); 169.8 kHz (electric power - non-EU countries)		
IP rating: IP65		
Operating temperature range: -4°F (-20°C) to 122°F (50°C)		
Battery		
Type: 10 AA-cell alkaline. Life: 20 hours at low power		
Compatibility		
Receiver must be running software version 7.0 or higher.		