



**eMobility Analyser**  
**A 1632**  
**Instruction manual**  
*Version 1.1.4, Code No. 20 752 886*

**Distributor:**

**Manufacturer:**

METREL d.d.  
Ljubljanska cesta 77  
1354 Horjul  
Slovenia  
web site: <http://www.metrel.si>  
e-mail: [metrel@metrel.si](mailto:metrel@metrel.si)



Mark on your equipment certifies that it meets requirements of all subjected EU regulations.

© 2018 METREL

*The trade names Metrel<sup>®</sup>, Smartec<sup>®</sup>, Eurotest<sup>®</sup>, Auto Sequence<sup>®</sup> are trademarks registered in Europe and other countries.*

*No part of this publication may be reproduced or utilized in any form or by any means without permission in writing from METREL.*

# Table of Contents

<b>1</b>	<b>General description</b>	<b>4</b>
1.1	Warnings and notes	4
1.1.1	Markings on the instrument:	5
1.1.2	Notes related to measurement functions	5
1.2	Battery and charging of Li-ion battery pack	6
1.2.1	Battery indication	6
1.2.2	Charger	6
1.2.3	Li – ion battery pack guidelines	6
1.3	Standards applied	7
<b>2</b>	<b>Accessories</b>	<b>8</b>
2.1	Standard set	8
2.2	Optional accessories	8
<b>3</b>	<b>Adapter description</b>	<b>9</b>
3.1	Front panel	9
<b>4</b>	<b>Analyser operation</b>	<b>11</b>
4.1	Power supply consideration	12
4.2	Operation modes	12
4.2.1	How to select or change the operating mode	13
4.3	Operation in autonomous mode	13
4.4	Remote operation	13
<b>5</b>	<b>Single tests</b>	<b>14</b>
5.1	Test connections to charging cables / stations	14
5.1.1	Connection of detachable charging cable for Mode 3 EVSE	14
5.1.2	Connection to Mode 2 charging cable	14
5.1.3	Connection to Mode 3 EVSE	15
5.2	Safety and functional tests	15
5.3	Diagnostic test – EV simulator	16
5.3.1	Remote connection	16
5.3.2	Autonomous mode	17
5.4	Diagnostic test – Monitor	17
5.5	Diagnostic test – CP Errors	18
5.6	Simulation of mains voltage errors	19
5.6.1	Simulation of connection of the charging cable to faulty mains	19
5.6.2	Simulation of a fault that occurs during operation	19
<b>6</b>	<b>Upgrading the adapter</b>	<b>20</b>
<b>7</b>	<b>Maintenance</b>	<b>21</b>
7.1	Periodic calibration	21
7.2	Fuses	21
7.3	Service	21
7.4	Cleaning	21
<b>8</b>	<b>Technical specifications</b>	<b>22</b>
8.1	Diagnostic test (EVSE)	22
8.2	PP, CP simulator	23
8.3	System state	23
8.4	Errors	24
8.5	Other	24
8.6	General data	25

# 1 General description

**eMobility Analyser** is a multi-function, portable, battery or mains powered test adapter intended for safety and functional testing of EVSE and charging cables for EV's.

Available functions and features offered by the **eMobility Analyser**:

- Diagnostic test for verification of proper operation of CP circuit;
- Simulation of electrical vehicle's CP and PP circuits;
- Simulation of errors on CP circuit and input mains;
- Accessible Inputs/ Outputs for connection of safety testers;
- Monitoring of communication between charging station and EV;
- Bluetooth communication with Metrel safety testers.

## 1.1 Warnings and notes

In order to maintain the highest level of operator safety while carrying out various tests and measurements Metrel recommends keeping your **eMobility Analyser** adapters in good condition and undamaged. When using the adapter, consider the following general warnings:

- ▶ The  symbol on the test equipment means »Read the Instruction manual with special care for safe operation«. The symbol requires an action!
- ▶ If the test equipment is used in a manner not specified in this Instruction manual, the protection provided by the equipment could be impaired!
- ▶ Follow the instructions in Instruction manual carefully, otherwise the use of the test equipment may be dangerous for the operator, the test equipment itself or for the tested object!
- ▶ Do not use the test equipment or any of the accessories if any damage is noticed!
- ▶ The input / output sockets are intended for test purposes only! Do not connect any other devices except appropriate test equipment.
- ▶ Do not connect the test equipment to a mains voltage different from the one defined on the label adjacent to the mains connector, otherwise it may be damaged.
- ▶ Use only earthed 1 – phase or 3 – phase mains supply system to power A 1632. PE must have low impedance to earth!
- ▶ Some pre-tests that could determine the PE fault on mains are disabled in Mode 2, to enable operation in IT voltage system. When using Mode 2, this note should be considered. See chapter 4.2 *Operation modes*.
- ▶ All normal safety precautions must be taken in order to avoid risk of electric shock while working on electrical installations!
- ▶ Only adequately trained and competent persons may operate the equipment.
- ▶ Service intervention or adjustment is only allowed to be carried out by competent authorized personnel!

### 1.1.1 Markings on the instrument:



Read the Instruction manual with special care to safety operation«. The symbol requires an action!



Mark on your equipment certifies that it meets requirements of all subjected EU regulations.



This equipment should be recycled as electronic waste.



This equipment is protected by reinforced insulation.

### 1.1.2 Notes related to measurement functions

#### R iso

- ▶ The resistances in OUTPUT area, between terminals L/L1-PE, L2-PE, L3-PE are ca 100 MΩ and between terminals L/L1-N, L2-N, L3-N, Lx-Ly are ca 200 MΩ. This should be considered if Riso is measured.
- ▶ The OUTPUT voltage LED indicators can light on during the insulation test. This has no particular meaning and has no influence on the measurement.

#### Diagnostic test (EVSE)

- ▶ Because of capacitive crosstalk between conductors in the three phase Output adapters a certain voltage  $U_{LxN}$  will be displayed on not connected phases.
- ▶ Do not use A 1631 Monitor adapter cable for charge currents higher than 32 A.

## 1.2 Battery and charging of Li-ion battery pack

The A 1632 adapter is powered with rechargeable Li-ion battery pack or with Mains supply.

### 1.2.1 Battery indication

The ON LED indicates the charge condition of battery.

Mains	Power	ON LED	
Connected	Off	blinking white	Analyser is charging
Connected	On	green	Analyser is switched on and charging
Not connected	On	green	Analyser is switched on, Ubat > 20% capacity
Not connected	On	red	Analyser is switched on, Ubat < 20% capacity
		blinking red- blue	Battery error or battery is completely empty

### 1.2.2 Charger

The battery is charged whenever the Mains power supply is connected to the A 1632 adapter. The intelligent charging system assures appropriate protection and maximal life time of the Li-ion battery. Typical charging time is 4 h and autonomous operation is >18 h.

### 1.2.3 Li – ion battery pack guidelines

Li–ion rechargeable battery pack requires routine maintenance and care in their use and handling. In order to achieve the maximum battery life time please consider:

**Use:**

- ❑ Do not leave batteries unused for extended periods of time – more than 6 months (self – discharge).
- ❑ Do not leave a battery on prolonged charge when not in use.

**Storage:**

- ❑ Charge or discharge the adapter's battery pack to approximately 50% of capacity before storage.
- ❑ Charge the adapter's battery pack to approximately 50% of capacity at least once every 6 months.

**Transportation:**

- ❑ Always check all applicable local, national, and international regulations before transporting a Li – ion battery pack.

## 1.3 Standards applied

The A 1632 adapter is manufactured and tested in accordance with the following regulations:

---

### *Electromagnetic compatibility (EMC)*

**EN 61326** Electrical equipment for measurement, control and laboratory use – EMC requirements Class A

---

### *Safety (LVD)*

**EN 61010 - 1** Safety requirements for electrical equipment for measurement, control and laboratory use – Part 1: General requirements

**EN 61010 - 2 – 030** Safety requirements for electrical equipment for measurement, control and laboratory use – Part 2-030: Particular requirements for testing and measuring circuits

**EN 61010 - 031** Safety requirements for hand-held probe assemblies for electrical measurement and test

---

### *Functional*

**EN 61557 series** Electrical safety in low voltage distribution systems up to 1000 V a.c. and 1500 V d.c. - Equipment for testing, measuring or monitoring of protective measures

**EN 61851 – 1** Electric vehicle conductive charging system Part 1: General requirements

---

### *Li – ion battery pack*

**IEC 62133** Secondary cells and batteries containing alkaline or other non-acid electrolytes - Safety requirements for portable sealed secondary cells, and for batteries made from them, for use in portable applications

### **Note about EN and IEC standards:**

- Text of this manual contains references to European standards. All standards of EN 6XXXX (e.g. EN 61010) series are equivalent to IEC standards with the same number (e.g. IEC 61010) and differ only in amended parts required by European harmonization procedure.

## 2 Accessories

The accessories consist of standard and optional accessories. Optional accessories can be delivered upon request. See *attached* list for standard configuration and options or contact your distributor or see the METREL home page: <http://www.metrel.si>.

### 2.1 Standard set

- eMobility Analyser A 1632
- Mains supply cord 1 phase 10 A plug to 3 phase 16 A plug adapter A 1633
- Test cable with Type 2 male plug connector, length 2 m, A 1634
- Test lead 2 mm / 4 mm safety banana plug adapter, red, length 1 m, A 1635
- Bag for accessories A 1271
- Instruction manual
- Calibration certificate

### 2.2 Optional accessories

See the attached sheet for a list of optional accessories and licence keys that are available on request from your distributor.



### 3 Adapter description

#### 3.1 Front panel

The operator's panel is shown on Figure 3.1 below.

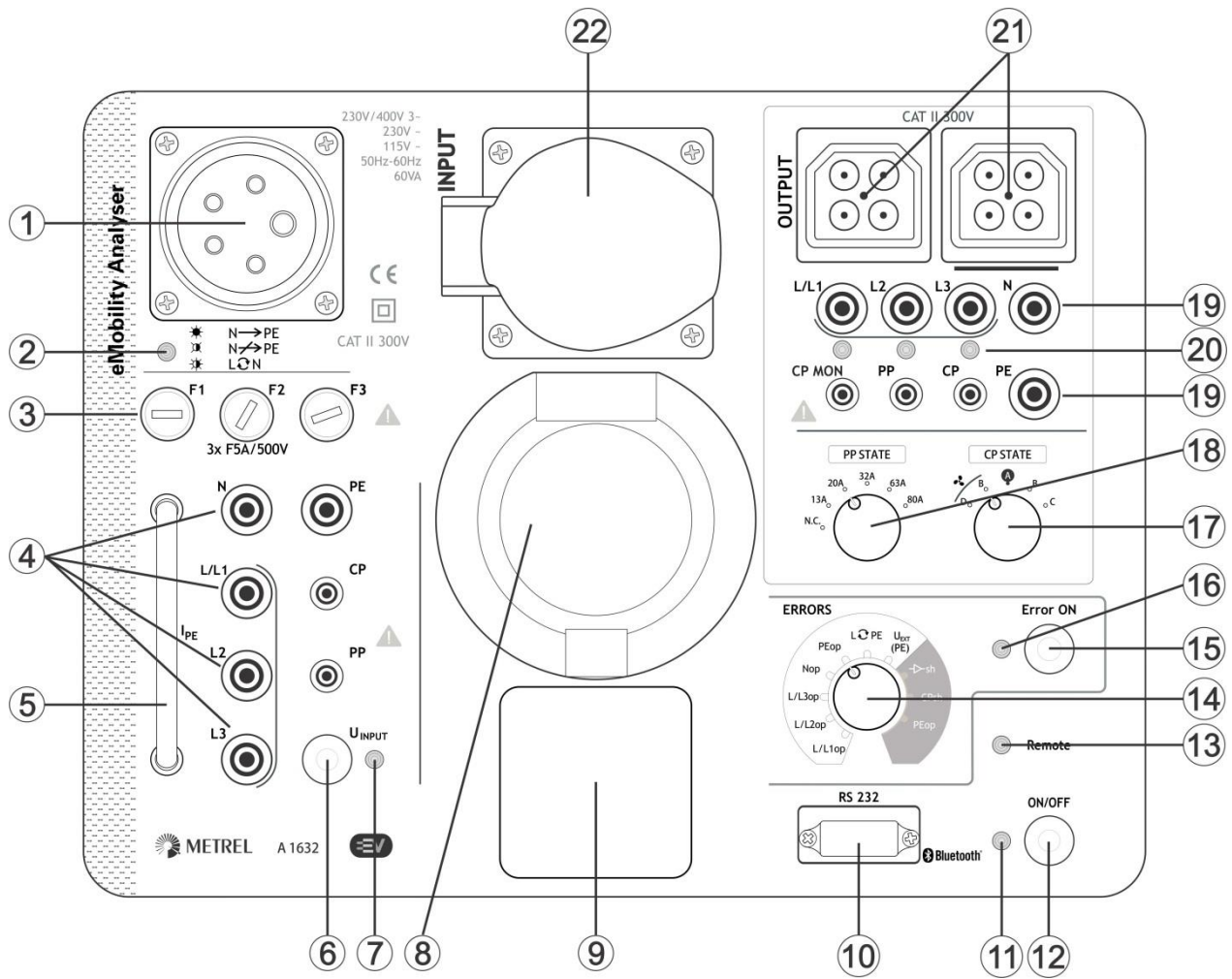

Figure 3.1: Front panel

1	Mains power supply inlet (CEE 16 A).
2	Mains red LED indicates connection to mains (set operation mode). See chapter 4.1 <i>Power supply consideration</i> for more information.
3	Input fuses (see chapter 7.2 <i>Fuses</i> for more information)
4	Lx/ N/ PE/ CP/ PP safety INPUT sockets for connection of a safety tester
5	Current loop for connection of leakage current clamp for measuring $I_{PE}$
6	$U_{INPUT}$ key Toggle to apply / not apply voltage to the INPUT connectors (1 phase socket, Type 2 connector, 3 phase socket, 4 mm/ 2 mm safety sockets)
7	$U_{INPUT}$ LED indicator ON = voltage applied, OFF = voltage not applied

8	Type 2 INPUT socket for connection of a 3 phase Mode 3 charging cable												
9	1 phase INPUT socket for connection of a 1 phase Mode 2 charging cable												
22	3 phase INPUT socket for connection of a 3 phase Mode 2 charging cable												
10	RS232 connection port (intended for firmware upgrade and service purposes)												
11	ON multicolour LED See chapter 1.2.1 <i>Battery indication</i> for more information.												
12	ON / OFF key Switches the eMobility Analyser On (short press) or Off ( 2 s press). Auto-off after 20 minutes of no-activity.												
13	Remote LED indicates that the adapter is controlled by Metrel safety tester (inclusive CP, PP and Error state)												
14	Rotary switch for selection of different simulated errors: See chapter 8.4 <i>Errors</i> for more information.												
15	Error ON key Switching On/Off the selected error.												
16	Error ON LED ON = Error applied, OFF = Error not applied												
17	Rotary switch for setting Control Pilot state (CP on OUTPUT side)												
	<table border="1"> <thead> <tr> <th>Position</th> <th>Description</th> </tr> </thead> <tbody> <tr> <td>D</td> <td>EV charged and ventilation</td> </tr> <tr> <td>B</td> <td>EV connected</td> </tr> <tr> <td>A</td> <td>no EV connected</td> </tr> <tr> <td>B</td> <td>EV connected</td> </tr> <tr> <td>C</td> <td>EV charged</td> </tr> </tbody> </table>	Position	Description	D	EV charged and ventilation	B	EV connected	A	no EV connected	B	EV connected	C	EV charged
Position	Description												
D	EV charged and ventilation												
B	EV connected												
A	no EV connected												
B	EV connected												
C	EV charged												
18	Rotary switch for setting Proximity Pilot current rating resistor (PP on OUTPUT side) [NC, 13 A, 20 A, 32 A, 63 A, 80 A]												
19	Lx/ N/ PE/ CP/ PP/ CP MON safety OUTPUT sockets for connection of a safety tester												
20	L/L1, L2, L3 OUTPUT LED's ON = mains voltage at the OUTPUT test connection present, OFF = mains voltage at the OUTPUT test connection not present.												
21	OUTPUT connectors for test cable connection to the output of charging cable or EVSE												

**Note:**

On INPUT side, the L/L1, L2, L3, N, PE, CP and PP safety sockets (4) are connected in parallel with Type 2 socket (8), 1 phase socket (9) and 3 phase socket (22).

## 4 Analyser operation

The eMobility Analyser can operate autonomously or it can be remote controlled via Bluetooth communication link with Metrel Instrument. Following test conditions can be set:

Keys, switches, LEDs	Relates to	Test condition
UINPUT On/Off = Off	INPUT L/L1,L2,L3,N,PE	No voltage on the input of charging cable, input is disconnected from mains
UINPUT On/Off = On Error ON = Off	INPUT L/L1,L2,L3,N,PE	Mains voltage NORMAL condition on the input of charging cable
UINPUT On/Off = On Error ON = On ERRORS INPUT is set	INPUT L/L1,L2,L3,N,PE	Mains voltage ERROR condition on the input of charging cable (selected by ERRORS switch position). See chapter 5.6 <i>Simulation of mains voltage errors</i> for more information.
PP STATE	OUTPUT PP	EV simulation, charging cable current rating
CP STATE Error ON = Off	OUTPUT CP	EV simulation, normal operation modes: A, B, C no ventilation, A, B, D ventilation required during charging
Error ON = On ERRORS OUTPUT is set	OUTPUT CP	EV simulation, fault on CP simulated:  sh – Diode short, CPsh – CP_PE short, PEop – PE open
Any combination	OUTPUT L/L1,L2,L3,N,PE	Connection at the output of charging cable / station. The condition depends on the set state of the instrument.

## 4.1 Power supply consideration



The 3-phase 16 A CEE inlet is intended for connection to Single and 3-phase Mains supply.

### Single phase connection

1 phase 10 A plug to 3 phase 16 A CEE cable connector adapter A 1633 should be used for single phase connection. It is suitable for internal battery charging and for single phase supply to INPUT section for testing of Single phase Mode 2 Charging cables.

### 3-phase connection

Testing of 3 phase Mode 2 Charging cables requires 3 phase Mains power supply to the eMobility Analyser and its INPUT section, neutral N wire connection is mandatory. Ordinary 3-phase CEE 16 A 5-wire extension cord can be used for Mains power supply.

Operation mode	Symbol	LED indication	Description
Mode 1	 N → PE	ON	Correct connection
Mode 2	 N ↗ PE	Blinking (5 s cycle)	Correct connection
	 L ↻ N	Blinking (~0.3 s cycle)	L – N crossed or wrong voltage system

#### Note:

- If mains voltage is out of standard levels for 115 V~, 230 V~ and 230 V / 400 V 3~, the MAINS LED is fast blinking, eMobility Analyser cannot be switched ON and operation with the adapter is not possible.

## 4.2 Operation modes

The analyser has two operation modes.

### Mode 1

Mode 1 is the preferred operating mode. It is indicated by one short beep when mains voltage is applied. In this mode the PE connection of the INPUT connectors is connected to the installation's N conductor. This prevents from nuisance tripping of the RCD when RCD or impedance tests are carried out.

This operation mode 1 is suitable for TN and TT voltage systems. The mains LED will show an error and the analyser cannot be switched on if connected to an IT voltage system.

### Mode 2

Mode 2 is indicated by three beeps when mains voltage is applied. In this mode the PE connection of the INPUT connectors is connected to the installation's PE conductor. This operation mode is suitable for any voltage system.



#### Note:

- In Mode 2 the RCDs in the installation can trip if they are more sensitive than the PRCD in the tested charging cable. Nuisance tripping of the RCD can be avoided if appropriate alternative connection for the RCD tests is used.

## 4.2.1 How to select or change the operating mode

### Setup procedure

- › Switch OFF the eMobility Analyser.
- › Press and hold U<sub>INPUT</sub> key for at least 5 s while switching ON the adapter (ON/OFF key). (Alternatively apply Mains supply while pressing and holding U<sub>INPUT</sub> key for at least 5 s.)
- › When releasing the U<sub>INPUT</sub> key, beep sound indicates the newly set mode:

	Single beep	Mode 1 selected
	3 - beeps	Mode 2 selected

- › eMobility Analyser is now ready to operate in new operating mode.

#### Note:

- › Repeat upper procedure to toggle between operating modes.

## 4.3 Operation in autonomous mode

In this operation mode there is no need for data connection with master instruments. The Remote LED is switched OFF. The eMobility Analyser test condition can be set with the switches and keys on the analyser's front panel.

## 4.4 Remote operation

For remote setting of test condition, the eMobility Analyser must be connected via Bluetooth with the Metrel safety tester first. See *Supported Instruments Selection Table* and instrument's Instruction manual, chapter *Settings* for more information. The Analyser Remote LED is lit ON and indicates that it is controlled by the Instrument. While in remote mode the analyser's keys are not operating (except the On/Off key) and the state of rotary switches is irrelevant. The test parameters are set by the instrument that controls the analyser.

Analyser Remote LED is lit ON only when associated Diagnostic test (EVSE) is selected on the Instrument. When other Instrument safety test is selected, Analyser cannot be remote controlled and Remote LED is lit OFF.

## 5 Single tests

### 5.1 Test connections to charging cables / stations

#### 5.1.1 Connection of detachable charging cable for Mode 3 EVSE

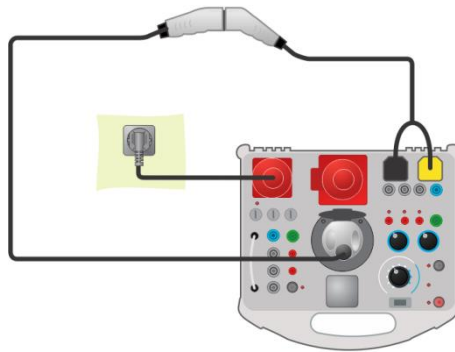

Figure 5.1: Connection of detachable charging cable for Mode 3 EVSE

#### 5.1.2 Connection to Mode 2 charging cable

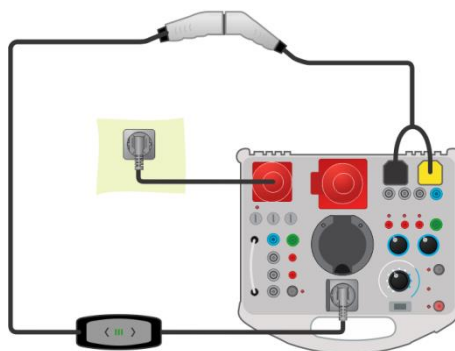

Figure 5.2: Connection of a 1 phase Mode 2 charging cable

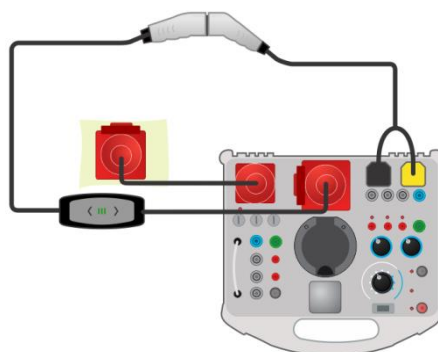

Figure 5.3: Connection of a 3 phase Mode 2 charging cable

### 5.1.3 Connection to Mode 3 EVSE

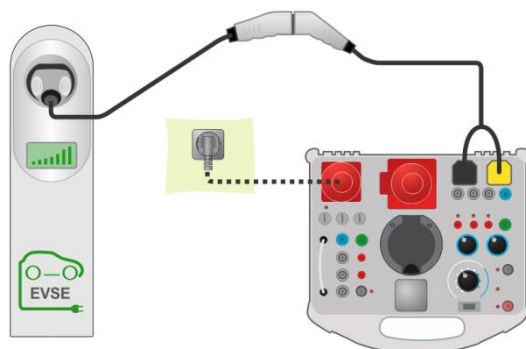

Figure 5.4: Connection of a Mode 3 EVSE

## 5.2 Safety and functional tests

In general the safety single tests and inspections can be carried out in combination with any safety testers. For more information how to carry out single tests and inspections refer to Instruction manual of the safety tester.

### Test circuit examples

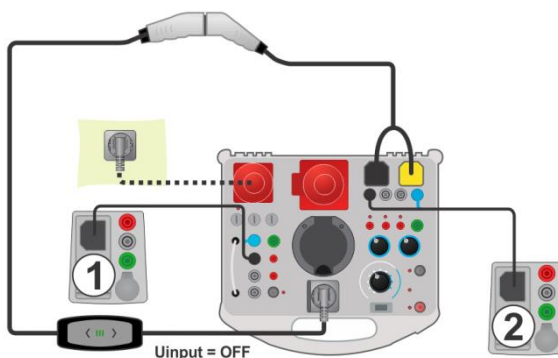

Figure 5.5: Example of RISO tests on a Mode 2 charging cable

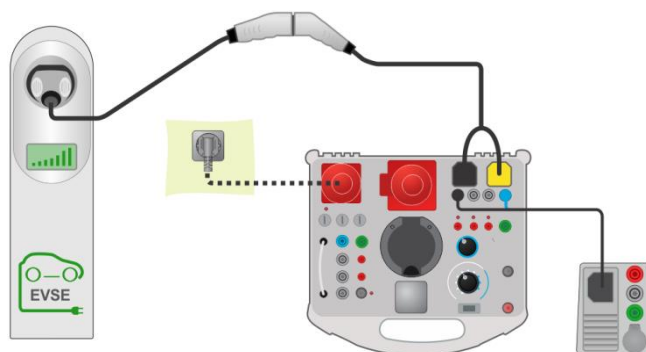

Figure 5.6: Example of Zline test on a Mode 3 EVSE

### Measurement procedure

- › Connect the charging cable /station to the eMobility Analyser (see test circuits above).
- › Select the measurement or inspection on the safety tester.
- › Set test parameters / limits of the selected measurement on the test instrument.
- › Put the charging cable / station into proper operating mode by setting the eMobility Analyser.
- › Connect the instrument test leads to the Analyser sockets (optional), see test circuits above and Instruction manual of test instrument.
- › Carry out the measurement or inspection.
- › Save results (optional).

## 5.3 Diagnostic test – EV simulator

This test is intended for simulation of an electrical vehicle with eMobility Analyser. The CP and PP states can be set in order to put the charging cable/ station into proper operation mode. The CP signal is analysed and the presence of voltage at the output of the charging cable / station is monitored.

### 5.3.1 Remote connection

The test is performed in combination with an external (master) instrument. The results are transmitted via Bluetooth communication link and displayed on the master instrument.

#### Test connections

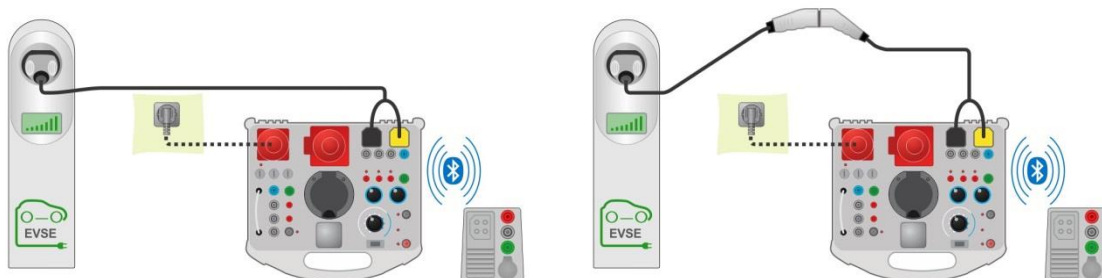

Figure 5.7: Diagnostic test - EV simulator test connection to the Mode 3 EVSE

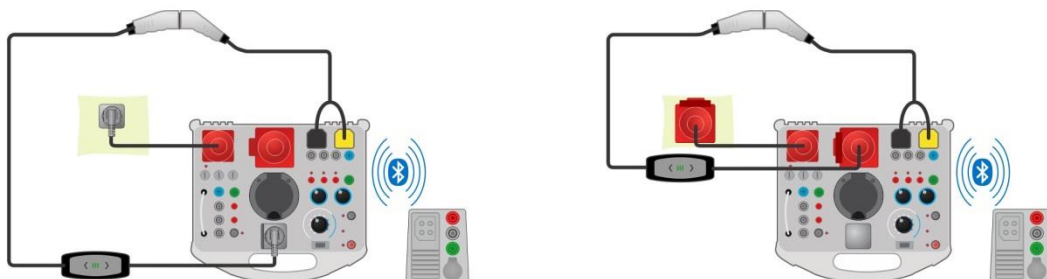

Figure 5.8: Diagnostic test - EV simulator test connection to the Mode 2 charging cable - Remote connection



### Measurement procedure

- › Connect the charging cable /station to the eMobility Analyser (see test circuits above).
- › Select Diagnostic test – EV simulator on the master instrument.
- › Set test parameters on the master instrument.
- › Check that the eMobility Analyser is in Remote mode (Bluetooth communication between eMobility Analyser and the master instrument is established).
- › Carry out the Diagnostic test.
- › Manually set status of the test (Optional).
- › Save results (optional).

For information about test parameters and displayed results refer to Instruction manual of the master instrument.

### 5.3.2 Autonomous mode

The eMobility Analyser test condition can be set with the switches and keys on the analyser's front panel. Only Mode 2 single and 3-phase charging cables can be tested in this mode.

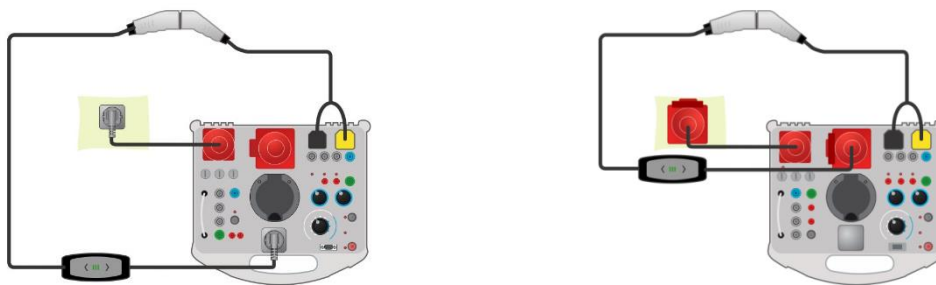

Figure 5.9: Diagnostic test - EVsimulator test connection to the Mode 2 charging cables - Autonomous mode

## 5.4 Diagnostic test – Monitor

This test monitors and analyses the CP signal and voltages between the charging cable / station and the electrical vehicle. For this test a monitor adapter cable (A 1631) is needed. The test is performed in combination with eMobility Analyser and an external (master) instrument. The results are transmitted via Bluetooth and displayed on the master instrument.

## Test connection

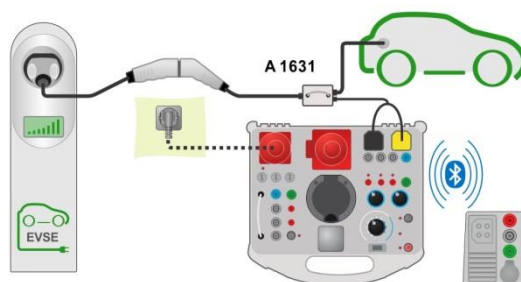

Figure 5.10: Example of a Diagnostic test - Monitor

## Measurement procedure

- › Connect the A 1631 cable adapter between the charging cable /station and the electrical vehicle.
- › Connect test probes to A 1632 eMobility Analyser.
- › Select the Diagnostic test – Monitor on the master instrument.
- › Set test parameters on the master instrument
- › Check that the eMobility Analyser is in Remote mode (Bluetooth communication between eMobility Analyser and the master instrument is established).
- › Carry out the Diagnostic test.
- › Manually set status of the test (optional).
- › Save results (optional).

For information about test parameters and displayed results refer to Instruction manual of the master instrument.

## 5.5 Diagnostic test – CP Errors

This test can simulate typical errors (diode shorted, CP – PE shorted, PE open) on the CP signal. The disconnection time of the charging cable / station, as a reaction to the simulated fault on the CP signal, is measured.

The test is performed in combination with an external (master) instrument. The results are transmitted via Bluetooth and displayed on the master instrument.

### Test connections

Refer to *Figure 5.7* and *Figure 5.8* for test connections.

### Measurement procedure

- › Connect the charging cable /station to the eMobility Analyser (see *Figure 5.7* and *Figure 5.8*).
- › Select the Diagnostic test – CP Error on the master instrument.
- › Set test parameters (CP error) on the master instrument.
- › Check that the eMobility Analyser is in Remote mode (Bluetooth communication between eMobility Analyser and the master instrument is established).
- › Carry out the Diagnostic test.
- › Manually set status of the test (optional).
- › Save results (optional).

For information about test parameters and displayed results refer to Instruction manual of the master instrument.

## 5.6 Simulation of mains voltage errors

Mode 2 charging cables have different means for testing the mains condition:

- › some tests are carried out when connected to the mains (at powerup),
- › some tests are monitoring the mains condition all time.

Therefore eMobility Analyser has two options for simulating input mains errors.

### 5.6.1 Simulation of connection of the charging cable to faulty mains

A faulty mains voltage is applied to INPUT terminals / sockets of eMobility Analyser.

#### Measurement procedure

- › Connect the charging cable to the eMobility Analyser (see *Figure 5.8*).
- › Select the error with ERRORS rotary switch.
- ›  $U_{\text{INPUT}}$  must be OFF. (If not already, set  $U_{\text{INPUT}}$  to OFF.)
- › Press the Error ON key to set error and power the charging cable.
- › Check the response of the tested charging cable.

### 5.6.2 Simulation of a fault that occurs during operation

The Error is activated after mains voltage (normal condition) is applied to INPUT terminals / sockets of eMobility Analyser.

#### Measurement procedure

- › Connect the charging cable to the eMobility Analyser (see *Figure 5.8*).
- › Select the error with ERRORS rotary switch.
- ›  $U_{\text{INPUT}}$  must be ON. (If not already, set  $U_{\text{INPUT}}$  to ON.)
- › Press the ERROR ON key to set error.
- › Check the response of the tested charging cable.

#### Note:

- › It is possible to carry out this simulation for following errors: L open (any phase), N open and PE open.

## 6 Upgrading the adapter

The A 1632 eMobility Analyser can be upgraded from a PC via the RS 232 communication port. This enables to keep the A 1632 eMobility Analyser up to date even if the standards or regulations change. Download the latest firmware on the Metrel download centre: <https://www.metrel.si/en/downloads/>

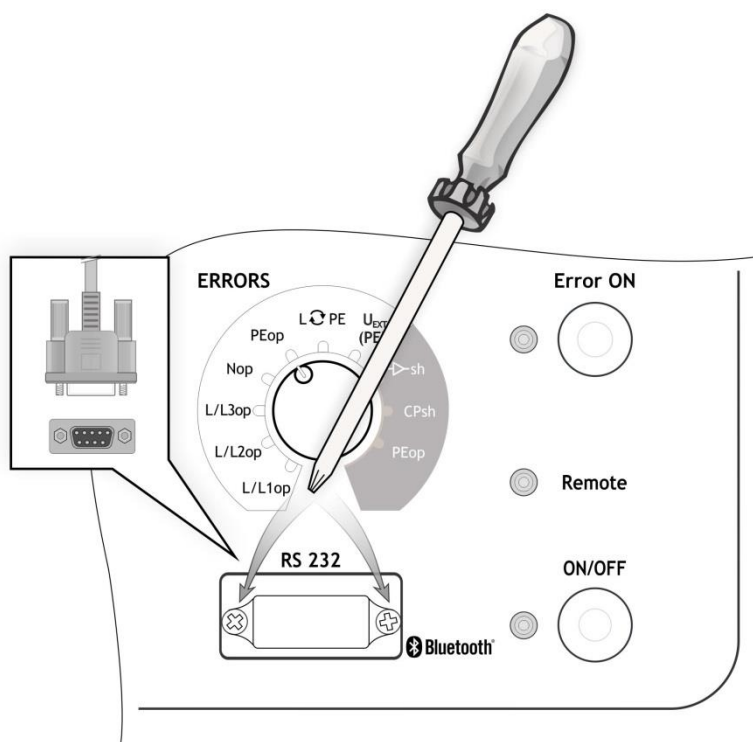

Figure 6.1: Upgrading the adapter

### Procedure

- › Unscrew two screws (as indicated in *Figure 6.1*) and remove RS 232 connector protection cover.
- › Connect standard DB9 RS232 interface cable on A 1632 and PC. (USB to RS232 adapter should be used if serial PC port is not available.)
- › Special upgrading software - **FlashMe** will guide you through the upgrading procedure.
- › When upgrade is finished, insert the RS 232 connector protection cover back.

### Notes:

- › Contact your dealer for more information.
- › Upgrading the firmware over Bluetooth communication is not possible.

## 7 Maintenance

### 7.1 Periodic calibration

It is essential that all measuring instruments are regularly calibrated in order for the technical specification listed in this manual to be guaranteed. We recommend an annual calibration.

### 7.2 Fuses

F1, F2, F3: F 5 A / 500 V / (32 × 6.3) mm (Breaking capacity: 50 kA)

Mains fuses intended for adapter protection.

#### Warnings!

- › **Switch off the adapter and disconnect all test accessories and mains cord before replacing the fuses.**
- › **Replace blown fuses with the same type as defined in this document.**

### 7.3 Service

For repairs under or out of warranty please contact your distributor for further information.

Unauthorized person is not allowed to open the analyser. There are no user replaceable parts inside the instrument.

### 7.4 Cleaning

Use a soft, slightly moistened cloth with soap water or alcohol to clean the surface of analyser. Leave the instrument to dry totally before using it.

#### Notes:

- › Do not use liquids based on petrol or hydrocarbons!
- › Do not spill cleaning liquid over the instrument!

## 8 Technical specifications

### 8.1 Diagnostic test (EVSE)

**U1N, U2N, U3N** – Mains voltage

Measuring range (V)	Resolution (V)	Accuracy
0 ... 440	1	$\pm(2\% \text{ of reading} + 2 \text{ digits})$

Nominal frequency range ..... 0 Hz, 14 Hz ... 500 Hz

**Field** – Phase rotation

Result displayed..... 1.2.3 or 3.2.1

**UCP+, UCP-** – Voltage

Measuring range (V)	Resolution (V)	Accuracy
-19.9 V ... 19.9 V	0.1	$\pm(2\% \text{ of reading} + 2 \text{ digits})$

Result..... positive, negative peak value (8  $\mu$ s interval)

**Freq** – Frequency

Measuring range (Hz)	Resolution (Hz)	Accuracy
500.0 ... 1500.0	0.1	$\pm 1\% \text{ of reading}$

**D** – Duty cycle

Measuring range (%)	Resolution (%)	Accuracy
0.1 ... 99.9	0.1	$\pm 10 \text{ digits}$

**levse** – Charging current available by charging cable / EVSE

Displayed range (A)	Resolution (A)	Accuracy
0.0 ... 99.9	0.1	Calculated value*

\*According to Table A.8 in IEC/EN 61851-1

**toff** – Disconnection time

Measuring range (ms)	Resolution (ms)	Accuracy
0 ... 399	1	$\pm(1\% \text{ of reading} + 5 \text{ digit})$

**Note:**

- › For  $t_{\text{off}}$  the L1-N channel is measured.

## 8.2 PP, CP simulator

### PP simulation

State	Resistance
N.C.	> 300 k $\Omega$
13 A	1.5 k $\Omega$ $\pm$ 1.5 %
20 A	680 $\Omega$ $\pm$ 1.5 %
32 A	220 $\Omega$ $\pm$ 1.5 %
63 A	100 $\Omega$ $\pm$ 1.5 %
80 A	56 $\Omega$ $\pm$ 5 %

### CP simulation

State	Resistance
A	> 300 k $\Omega$
B	2.74 k $\Omega$ $\pm$ 1.5 %
C	882 $\Omega$ $\pm$ 1.5 %
D	246 $\Omega$ $\pm$ 1.5 %

## 8.3 System state

### Possible systems states (measured interpreted by the Analyser\*)

State	Meaning
A1	no EV connected
A2	no EV connected / PWM
B1	EV connected
B2	EV connected / PWM
C1	EV charged
C2	EV charged / PWM
D1	EV charged and ventilation
D2	EV charged and ventilation / PWM
E	Error
F	Failure
Invalid	CP signal can't be classified

\* According to Table A.4 in IEC/EN 61851-1.

If more states are displayed as result, all states can be considered as valid according to IEC/EN 61851-1.

## 8.4 Errors

Errors	Applied to:	Parameter	Description
L/L1op	INPUT		L/L1 conductor opened
L/L2op			L/L2 conductor opened
L/L3op			L/L3 conductor opened
Nop			N conductor opened
PEop			PE conductor opened
L↻PE			L/L1and PE conductors crossed*
U <sub>EXT</sub> (PE)			External voltage on PE (on input side)*
 sh	OUTPUT	E1	CP diode shorted
CPsh		E2	CP - PE shorted
PEop		E3	PE opened

\*mains voltage is connected to PE via a 1MΩ resistor

## 8.5 Other

Output voltage LED.....ON:  $U_{Lx-N} > 50 \text{ V}$



## 8.6 General data

Battery power supply .....	7.2 V d.c. (4.4 Ah Li-ion)
Battery charging time .....	typical 4 h (deep discharge)
Mains power supply .....	115 V ~ ± 10 %
	230 V ~ ± 10 %
	230 V / 400 V 3~ ± 10 %
	50 Hz - 60 Hz, 60 VA

Protection category ..... 300 V CAT II

### Battery operation time:

Idle state .....	> 32 h
Diagnostic test .....	> 18 h

Protection classification..... reinforced insulation

Measuring category..... 300 V CAT II

Pollution degree..... 2

Degree of protection..... IP 65 (case closed), IP 40 (case open)

..... IP 20 (mains test socket)

Dimensions (w × h × d)..... 36 cm x 16 cm x 33 cm

Weight ..... 5.2 kg, (without accessories)

Sound / Visual warnings ..... yes

### Reference conditions:

Reference temperature range ..... 25 °C ± 5 °C

Reference humidity range ..... 40 %RH ... 60 %RH

### Operation conditions:

Working temperature range..... -10 °C ... 50 °C

Maximum relative humidity..... 90 %RH (0 °C ... 40 °C), non-condensing

Working nominal altitude ..... up to 3000 m

### Storage conditions:

Temperature range ..... -10 °C ... 70 °C

Maximum relative humidity..... 90 %RH (-10 °C ... 40 °C)

..... 80 %RH (40 °C ... 60 °C)

### RS 232 communication:

RS 232 serial communication..... galvanic separated

Baud rate: ..... 115200 baud rate, 1 stop bit, no parity

Connector: ..... standard RS232 9-pin D female

### Bluetooth communication:

Bluetooth module ..... class 2

Specifications are quoted at a coverage factor of  $k = 2$ , equivalent to a confidence level of approximately 95 %.

Accuracies apply for 1 year in reference conditions. Temperature coefficient outside these limits is 0.2 % of measured value per °C, and 1 digit.