



# COMBITEST422

User manual





**TABLE OF CONTENTS**

1. PRECAUTIONS AND SAFETY MEASURES .....	3
1.1. Preliminary instructions.....	3
1.2. During use.....	4
1.3. After use.....	4
1.4. Definition of measurement (overvoltage) category.....	4
2. GENERAL DESCRIPTION .....	5
2.1. Instrument functions .....	5
3. PREPARATION FOR USE .....	6
3.1. Initial checks.....	6
3.2. Instrument power supply.....	6
3.3. Storage.....	6
4. NOMENCLATURE.....	7
4.1. Instrument description .....	7
4.2. Description of measuring leads.....	7
4.3. Keyboard description.....	8
4.4. Display description .....	8
4.5. Initial screen .....	8
5. GENERAL MENU .....	9
5.1. SET – Instrument settings .....	9
5.1.1. Language .....	9
5.1.2. Country.....	10
5.1.3. Electrical system .....	10
5.1.4. General settings.....	11
5.1.5. Auto Start feature.....	11
5.1.6. Date and time.....	11
5.1.7. Information.....	11
6. OPERATING INSTRUCTIONS.....	12
6.1. AUTO: Automatic test sequence (Ra $\frac{1}{2}$ , RCD, M $\Omega$ ).....	12
6.1.1. Anomalous situations.....	19
6.2. DMM: Digital multimeter function .....	20
6.3. RPE: Continuity of protective conductors.....	22
6.3.1. TMR mode .....	24
6.3.2. > $\phi$ < mode .....	25
6.3.3. Anomalous situations.....	26
6.4. Lo $\Omega$ : Continuity of protective conductors with 10A.....	27
6.4.1. Anomalous situations.....	29
6.5. M $\Omega$ : Measurement of insulation resistance .....	30
6.5.1. TMR mode .....	34
6.5.2. AUTO mode .....	35
6.5.3. Anomalous situations.....	36
6.6. RCD: Test on differential switches.....	38
6.6.1. AUTO mode .....	41
6.6.2. AUTO $\blacksquare$ mode .....	42
6.6.3. x $\frac{1}{2}$ , x1, x5 modes.....	43
6.6.4. $\blacksquare$ mode .....	44
6.6.5. Anomalous situations.....	45
6.7. LOOP: Line/Loop impedance and overall earth resistance .....	48
6.7.1. Test types.....	51
6.7.2. Test leads calibration (ZEROLoop).....	53
6.7.3. STD Mode – Generic test .....	55
6.7.4. Br.Cap mode – Verify of breaking capacity of protection device.....	57
6.7.5. TripT - Verify of protection coordination.....	59
6.7.6. Ra $\frac{1}{2}$ 2-wire test - Verify of protection against indirect contacts.....	61
6.7.7. Ra $\frac{1}{2}$ 3-wire test - Verify of protection against indirect contacts.....	63
6.7.8. Verify of protection against indirect contacts (IT systems) .....	65
6.7.9. Verify of protection against indirect contacts (TT systems) .....	67

6.7.10.	Verify of protection against indirect contacts (TN systems).....	69
6.7.11.	Anomalous situations.....	71
6.8.	LoZ: Line/Loop impedance with high resolution.....	74
6.9.	1,2,3: Phase sequence and phase concordance test.....	75
6.9.1.	Anomalous situations.....	78
6.10.	$\Delta V\%$ : Voltage drop of main lines.....	79
6.10.1.	Anomalous situations.....	82
7.	STORING RESULTS.....	86
7.1.	Saving measures.....	86
7.2.	Recall of data to display and memory deletion.....	87
8.	CONNECTING THE INSTRUMENT TO THE PC.....	88
9.	MAINTENANCE.....	89
9.1.	General information.....	89
9.2.	Replacement of the batteries.....	89
9.3.	Cleaning the instrument.....	89
9.4.	End of life.....	89
10.	TECHNICAL SPECIFICATIONS.....	90
10.1.	Technical characteristics.....	90
10.2.	Reference guidelines.....	93
10.3.	General characteristics.....	93
10.4.	Environment.....	93
10.4.1.	Environmental conditions for use.....	93
11.	SERVICE.....	94
11.1.	Warranty conditions.....	94
11.2.	Service.....	94
12.	THEORETICAL APPENDIXES.....	95
12.1.	Continuity of protective conductors.....	95
12.2.	Insulation resistance.....	95
12.3.	Checking circuit separation.....	96
12.4.	Test on differential switches (RCD).....	99
12.5.	Verify of the breaking capacity of protection devices.....	100
12.6.	Verify of protection against indirect contacts in TN systems.....	101
12.7.	$R_{a\pm}$ test in TN systems.....	103
12.8.	Verify of protection against indirect contacts in TT systems.....	104
12.9.	Verify of protection against indirect contacts in IT systems.....	105
12.10.	Verify of protection coordination L-L, L-N and L-PE.....	106
12.11.	Verification of voltage drop on main lines.....	107

## 1. PRECAUTIONS AND SAFETY MEASURES

The instrument has been designed in compliance with guidelines IEC/EN61557, BS7671 17th and 18th editions and IEC/EN61010, relevant to electronic measuring instruments. Before and after carrying out the measurements, carefully observe the following instructions:

- Do not carry out any voltage or current measurement in humid environments.
- Do not carry out any measurements in case gas, explosive materials or flammables are present, or in dusty environments.
- Avoid any contact with the circuit being measured if no measurements are being carried out.
- Avoid contact with exposed metal parts, with unused measuring leads, etc.
- Do not carry out any measurement in case you find anomalies in the instrument such as deformations, breaks, substance leaks, absence of display on the screen, etc.
- Pay special attention when measuring voltages higher than 25V in special environments (such as construction sites, swimming pools, etc.) and higher than 50V in normal environments, since a risk of electrical shock exists.
- Only use original accessories.

The following symbols are used in this manual:



CAUTION: observe the instructions given in this manual; improper use could damage the instrument, its components or create dangerous situations for the operator.



High voltage danger: electrical shock hazard.



Double insulation



AC voltage or current



DC voltage or current



Connection to earth



The symbol indicates that the instrument must not be connected to systems with phase-to-phase rated delta voltage higher than 415V.

### 1.1. PRELIMINARY INSTRUCTIONS

- This instrument has been designed for use in the environmental conditions specified in § 10.4.1. Do not use in different environmental conditions.
- The instrument may be used for measuring and verifying the safety of electrical systems. Do not use on systems exceeding the limit values specified in § 10.1
- We recommend following the normal safety rules devised to protect the user against dangerous currents and the instrument against incorrect use.
- Only the accessories supplied with the instrument guarantee compliance with safety standards. They must be in good conditions and be replaced with identical models, when necessary.
- Make sure the batteries are correctly installed.
- Before connecting the test leads to the circuit being measured, check that the desired function has been selected

## 1.2. DURING USE

Please carefully read the following recommendations and instructions:



### CAUTION

Failure to comply with the caution notes and/or instructions may damage the instrument and/or its components or be a source of danger for the operator.

- Before changing function, disconnect the test leads from the circuit under test.
- When the instrument is connected to the circuit under test, never touch any terminal, even if unused.
- Avoid measuring resistance if external voltages are present. Even if the instrument is protected, excessive voltage could cause damage.

## 1.3. AFTER USE

When measurements are completed, turn off the instrument by pressing and holding the **ON/OFF** key for some seconds. If the instrument is not to be used for a long time, remove the batteries and follow the instructions given in § 3.3

## 1.4. DEFINITION OF MEASUREMENT (OVERVOLTAGE) CATEGORY

Standard "IEC/EN61010-1: Safety requirements for electrical equipment for measurement, control and laboratory use, Part 1: General requirements" defines what measurement category, commonly called overvoltage category, is. § 6.7.4: Measured circuits, reads: circuits are divided into the following measurement categories:

- **Measurement category IV** is for measurements performed at the source of a low-voltage installation.  
*Examples are electricity meters and measurements on primary overcurrent protection devices and ripple control units.*
- **Measurement category III** is for measurements performed on installations inside buildings.  
*Examples are measurements on distribution boards, circuit breakers, wiring, including cables, bus-bars, junction boxes, switches, socket-outlets in fixed installation, and equipment for industrial use and some other equipment, for example, stationary motors with permanent connection to fixed installation.*
- **Measurement category II** is for measurements performed on circuits directly connected to the low-voltage installation.  
*Examples are measurements on household appliances, portable tools and similar equipment.*
- **Measurement category I** is for measurements performed on circuits not directly connected to MAINS.  
*Examples are measurements on circuits not derived from MAINS, and specially protected (internal) MAINS-derived circuits. In the latter case, transient stresses are variable; for that reason, the standard requires that the transient withstand capability of the equipment is made known to the user*

## 2. GENERAL DESCRIPTION

### 2.1. INSTRUMENT FUNCTIONS

The instrument can perform the following tests:

- **RPE** Continuity test of earth, protective and equipotential conductors with test current higher than 200mA and open-circuit voltage between 4V and 24V
- **MΩ** Measurement of insulation resistance with continuous test voltage of 50V, 100V, 250V, 500V or 1000V DC
- **LOOP** Measurement of line impedance/Loop P-N, P-P, P-E with calculation of the assumed short-circuit current, overall earth resistance without causing the RCD tripping ( $RE_{\Sigma}$ ), check of the interruption capacity of magnetothermal protections (MCB) and fuses, protection check in case of indirect contacts with 2-wire and 3-wire connection
- **LoZ** Measurement of line impedance/Loop P-N, P-P, P-E with calculation of the assumed short-circuit current with high resolution (0.1mΩ) (by means of optional accessory IMP57)
- **ΔV%** Measurement of percentage voltage drop on main lines
- **LoΩ** Continuity test of earth, protective and equipotential conductors with test current higher than 10A (by means of optional accessory 16230)
- **RCD** Test on molded case RCD standard, General and Selective of type A ( $\sim$ ), AC ( $\sim$ ) and B ( $\overline{\sim}$ ) of the following parameters: tripping time, tripping current, contact voltage
- **AUTO** Automatic sequence measurements of  $RA_{\Sigma}$ , RCD, MΩ functions with 3-wire connection
- **1,2,3** Indication of phase sequence with 1-terminal method
- **DMM** Multimeter function for Phase-Neutral, Phase-Phase, Phase-PE voltage measurements and frequency

### **3. PREPARATION FOR USE**

#### **3.1. INITIAL CHECKS**

Before shipping, the instrument has been checked from an electric as well as mechanical point of view. All possible precautions have been taken so that the instrument is delivered undamaged. However, we recommend checking it to detect any damage possibly suffered during transport. In case anomalies are found, immediately contact the Dealer. We also recommend checking that the packaging contains all the components. In case of discrepancy, please contact the Dealer. In case the instrument should be returned, please follow the instructions given in § 11.

#### **3.2. INSTRUMENT POWER SUPPLY**

The instrument is powered by 6x1.5V alkaline batteries of type AA LR06 supplied with the instrument. The “” symbol indicates the charge level of the batteries. To replace the batteries refer to § 9.2.

**The instrument is capable of keeping data stored even without batteries.**

The instrument has an AutoPower OFF function (which can be deactivated) after 5 minutes idling.

#### **3.3. STORAGE**

In order to guarantee precise measurement, after a long storage time under extreme environmental conditions, wait for the instrument to come back to normal condition (see § 10.4.1).



## 4. NOMENCLATURE

### 4.1. INSTRUMENT DESCRIPTION

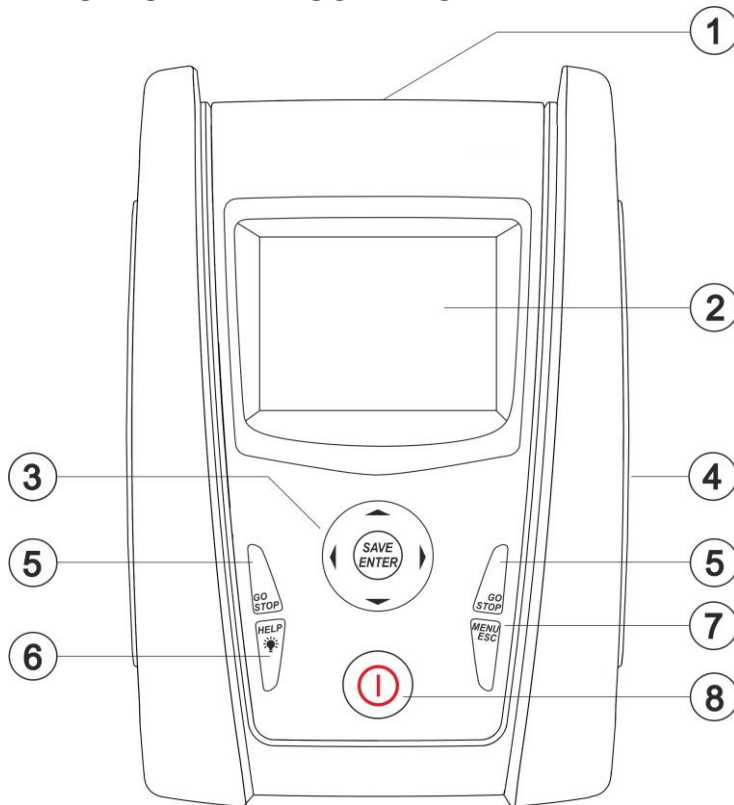

#### CAPTION:

1. Inputs
2. LCD display
3. ▼, ▲, ►, ◀, **SAVE/ENTER** keys
4. Compartment of the connector for optical cable/USB port
5. **GO/STOP** keys
6. **HELP**/ key
7. **ESC/MENU** key
8. **ON/OFF** key

Fig. 1: Description of the front part of the instrument



#### CAPTION:

1. Connector for remote lead
2. **B1, B3, B4** inputs

Fig. 2: Description of the upper part of the instrument

### CAUTION



The instrument performs the check of voltage on PE by comparing the voltage at B4 input and the ground potential induced on instrument side by mean the user's hand, so in order to check voltage on PE, **it's mandatory to hold the instrument case on the left or on the right side**

### 4.2. DESCRIPTION OF MEASURING LEADS

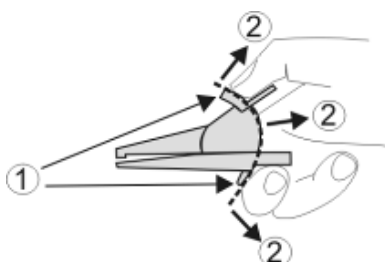

#### CAPTION:

1. Hand protection
2. Safe area

Fig. 3: Description of measuring leads

### 4.3. KEYBOARD DESCRIPTION

The keyboard includes the following keys:



**ON/OFF** key to switch on/off the instrument



**ESC** key to exit the selected menu without confirming  
**MENU** key to back to general Menu on each moment



◀ ▲ ▶ ▼ keys to move the cursor through the different screens in order to select the desired programming parameters  
**SAVE/ENTER** key to save the selected setup parameters (SAVE) and to select from menu the desired function (ENTER)



**GO** key to start the measurement  
**STOP** key to stop the measurement



**HELP** key to access the online help and display the possible connections between the instrument and the system for each selected function  
 key (**continuous pressure**) to adjust the display backlight

### 4.4. DISPLAY DESCRIPTION

The display is an COG LCD module, 128x128 points. The first line of the display indicates the type of active measurement, the date/time and the battery charge indication

RPE	15/10 – 18:04	
R = - - - Ω		
I <sub>test</sub> = - - - mA		
Measuring...		
STD	2.00Ω	0.12Ω
MODE	Lim	> φ<

### 4.5. INITIAL SCREEN

When switching on the instrument, the initial screen appears for a few seconds. It shows:

- The instrument model
- The manufacturer
- The serial number (SN:) of the instrument
- The Firmware version of the two instrument's internal microprocessors (FW and HW)
- The date of instrument calibration (Calibration date:)

<b>COMBITEST422</b>
<b>ELMA</b>
SN: 21010037
HW: 1.03
FW: 1.03
Calibration date: 15/01/2021

After a few seconds, the instrument switches to general menu screen

## 5. GENERAL MENU

Pressing the **MENU/ESC** key in any condition of the instrument allows to go back to the general menu in which internal parameters may be set and the desired measuring function may be selected.

MENU	15/10 – 18:04	MENU	15/10 – 18:04
AUTO	: Ra, RCD, MΩ	LoZ	: H.Resol.Imp.Test
DMM	: Voltage/Freq.	1,2,3	: Phase Sequence
<b>RPE</b>	<b>: Continuity</b>	ΔV%	: Voltage drop
LoΩ	: H.Resol.Res.Test	SET	: Settings
MΩ	: Insulation	MEM	: Data saved
RCD	: Auto, Ramp, Man	PC	: Data transfer
LOOP	: ZE/ZS Impedance		
	▼		▼

Selecting one of the listed measurements with the cursor and confirming with **ENTER** the instrument shows the desired measurement at display.

### 5.1. SET – INSTRUMENT SETTINGS

Move the cursor to **SET** by means of the arrow keys (▲,▼) and confirm with **ENTER**. Subsequently, the displays shows the screen which allows accessing the various instrument settings.

The settings will remain valid also after switching off the instrument.

SET	15/10 – 18:04
<b>Language</b>	
Country	
Electrical system	
General settings	
Date and time	
Information	

#### 5.1.1. Language

Move the cursor to **Language** by means of the arrow keys (▲,▼) and confirm with **ENTER**. Subsequently, the displays shows the screen which allows setting the instrument language.

Select the desired option by means of the arrow keys (▲,▼). To store settings, press the **ENTER** key, to exit the changes made, press the **ESC** key.

SET	15/10 – 18:04
<b>English</b>	
Italian	
Español	
Deutsch	
Français	

### 5.1.2. Country

Move the cursor to **Country** by means of the arrow keys (▲,▼) and confirm with **ENTER**. Subsequently, the displays shows the screen in order to select the reference country which have influence on the LOOP and  $R_{a\pm}$  measurements

Select the desired option by means of the arrow keys (▲,▼). To store settings, press the **ENTER** key, to exit the changes made, press the **ESC** key.



### 5.1.3. Electrical system

Move the cursor to **Electrical system** by means of the arrow keys (▲,▼) and confirm with **ENTER**. Subsequently, the display shows the screen which allows to set the followed parameters:

- **Vnom** → the Phase-Neutral or Phase-PE nominal voltage (110V,115V,120V, 127V,133V,220V,230V,240V) to use in the calculation of prospective short circuit current
- **Frequency** → the system frequency (50Hz, 60Hz)
- **System** → the type of electric power supply system (TT, TN or IT)
- **Contact Volt** → the limit of contact voltage (25V, 50V)
- **I RCD** → the type of trip out RCD current visualization (Real, Nom). With “Nom” option the instrument shows the normalized value of trip out current (referred to the nominal current). **Example:** for RCD type A with  $I_{dn}=30\text{mA}$  the effective value of normalized trip out current can be up to **30mA**. With “Real” option the instrument shows the effective value of the trip out current by considering the coefficients indicated by the IEC/EN61008 and IEC/EN61009 guidelines (1.414 for RCD type A, 1 for RCD type AC, 2 for RCD type B). **Example:** for RCD type A with  $I_{dn}=30\text{mA}$  the effective value of trip out current can be up to **30mA \* 1.414 = 42mA**
- **RCD/RCCB** → Selecting “RCD” option the instrument performs the tripping time test with all multipliers in normally conditions. Selecting “RCCB” option, **only for 30mA devices**, the instrument performs tripping time test with x5 multiplier with test current of 250mA (type AC) and 350mA (type A)
- **Isc Factor** → (**only for Norway country**) possibility to select and **the value of ISC factor (0.01 ÷ 1.00) to use in the calculation of prospective short circuit current**

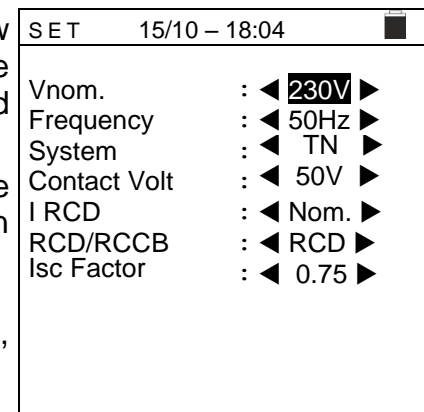

Select the desired option by means of the arrow keys (▲,▼). To store settings, press the **ENTER** key, to exit the changes made, press the **ESC** key.

#### 5.1.4. General settings

Move the cursor to **General settings** by means of the arrow keys (▲,▼) and confirm with **ENTER**. Subsequently, the display shows the screen which allows to enable/disable the auto power off, enable/disable the sound of function key for each pressure and enable/disable the Auto Start function (automatic start) in the RCD and LOOP functions (see § 5.1.5)

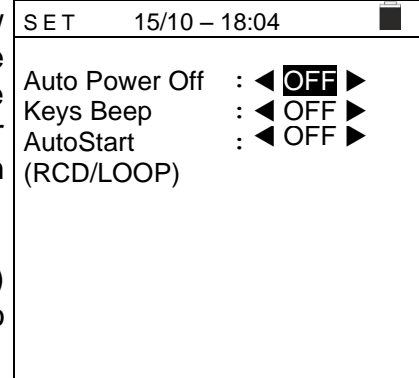

Select the desired option by means of the arrow keys (▲,▼) and the (◀, ▶). To store settings, press the **ENTER** key, to exit the changes made, press the **ESC** key

#### 5.1.5. Auto Start feature

The AutoStart feature allows to run automatically the RCD and LOOP measurements. **In order to correct use the AutoStart mode it is NECESSARY to run the FIRST test by pressing the GO/STOP key on the instrument or the START key on the remote lead.**

After first test completion, as soon as the instrument detects in input a steady voltage within the allowed range, run the test without pressing the **GO/STOP** key on the instrument or the **START** key on the remote lead.

#### 5.1.6. Date and time

Move the cursor to **Date and time** by means of the arrow keys (▲,▼) and confirm with **ENTER**. Subsequently, the display shows the screen which allows to set the system date/time. Select "Format" field to set the European system ("DD/MM/YY, hh:mm" **EU** format) or the American system ("MM/DD/YY hh:mm" **USA** format).

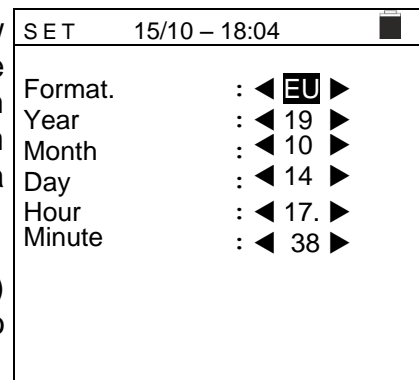

Select the desired option by means of the arrow keys (▲,▼) and the (◀, ▶). To store settings, press the **ENTER** key, to exit the changes made, press the **ESC** key.

#### 5.1.7. Information

Move the cursor to **Info** by means of the arrow keys (▲,▼) and confirm with **ENTER**. Subsequently, the display shows the initial screen as indicated in the screen at side.

Press **ESC** key to return to main menu

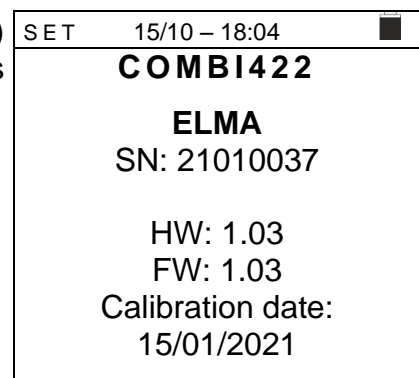

## 6. OPERATING INSTRUCTIONS

### 6.1. AUTO: AUTOMATIC TEST SEQUENCE (RA<sub>T</sub>, RCD, MΩ)

This function allows to perform in automatic sequence the following measurements:

- Overall earth resistance without causing the RCD tripping (Ra<sub>T</sub>)
- Tripping current and tripping time of **General RCD** type A (M), AC (∞) or B (∞)
- **Insulation resistance with test voltages 50,100,250,500,1000VDC**

### CAUTION



Testing the RCD's tripping time causes the RCD's tripping. **Therefore, check that there are NO users or loads connected downstream of the RCD being tested which could be damaged by a system downtime.** Disconnect all loads connected downstream of the RCD as they could produce leakage currents further to those produced by the instrument, thus invalidating the results of the test.

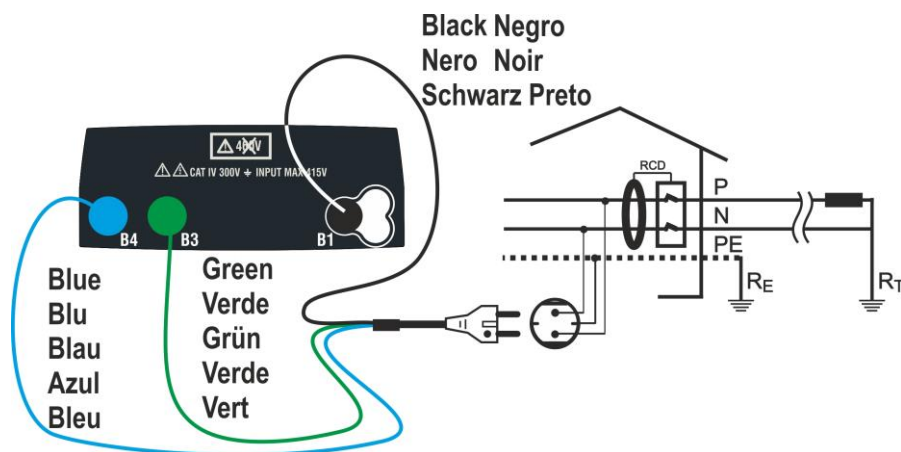

Fig. 4: Instrument connection through Mains Plug

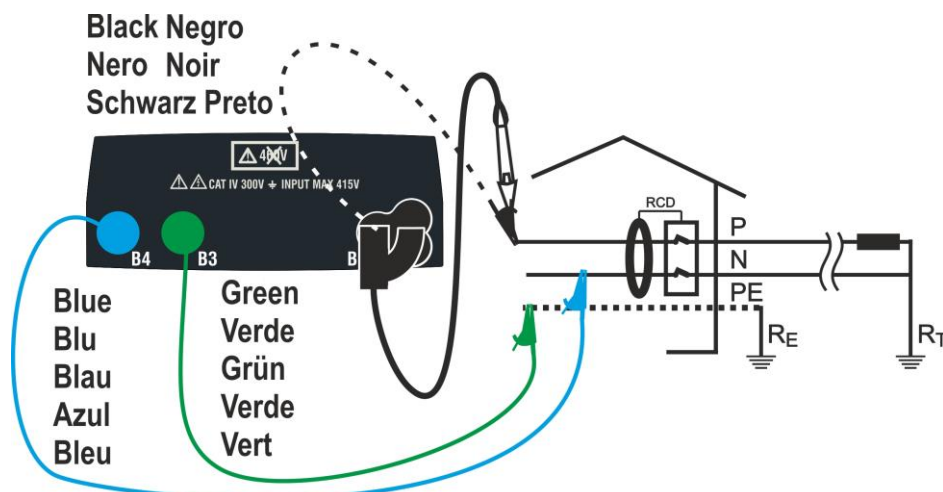

Fig. 5: Instrument connection by means of single cables and remote lead

- Press the **MENU** key, move the cursor to **AUTO** in the main menu by means of the arrow keys (**▲**, **▼**) and confirm with **ENTER**. Subsequently the instrument displays a screen similar to the one reported here to the side.

Select the “UK” country (see § 5.1.2), the options “TN”, “25 or 50V”, “50Hz or 60Hz” and the reference voltage in the general settings of the instrument (see § 5.1.3)

AUTO	15/10 – 18:04	■	
TN	>◀◂◃		
Isc=--- A	ZL-N=--- Ω		
Ifc=--- A	ZL-PE=--- Ω		
Trcd=---ms	Ircd=---mA		
FREQ=0.00Hz	Ut=---V		
VL-PE=0V	VL-N=0V		
30mA		500V	1.00MΩ
IΔn	Type	Vtest	Lim

- Use the **◀**, **▶** keys to select the parameter to be modified, and the **▲**, **▼** keys to modify the parameter value
  - **IΔn** → The virtual key allows setting the nominal value of the RCD’s tripping current, which may be: **6mA**, **10mA**, **30mA**
  - **Type** → The virtual key enables the selection of the RCD type, which may be: **AC** () or **A** ()
  - **Vtest** → This key allows to select the DC test voltage generated during the measurement. The following values are available: **50V**, **100V**, **250V**, **500V**, **1000V**
  - **Lim** → This key allows the selection of the minimum limit threshold in order to consider the insulation measurement correct. The following values are available: **0.05MΩ**, **0.10MΩ**, **0.23MΩ**, **0.25MΩ**, **0.50MΩ**, **1.00MΩ**, **100MΩ**

### CAUTION



- Make sure to select the correct value when setting the RCD’s test current. If setting a current higher than the nominal current of the device being tested, the RCD would be tested at a current higher than the correct one, thus facilitating a faster tripping of the switch
- The “>◀◂◃” symbol indicate that the test cables or the cable with shuko plug is just calibrated in the LOOP section (see § 6.7.2). The AUTO function is referred to this value

- Insert the green, blue and black connectors of the three-pin shuko cable into the corresponding input leads B1, B3 and B4 of the instrument. As an alternative, use the single cables and apply the relevant alligator clips to the free ends of the cables. It is also possible to use the remote lead by inserting its multipolar connector into the input lead B1. Connect the shuko plug, the alligator clips or the remote lead to the electrical mains according to Fig. 4 or Fig. 5
- Note the correct voltage values between L-N and L-PE as shown in the screen to the side

AUTO	15/10 – 18:04	■	
TN	>◀◂◃		
Isc=--- A	ZL-N=--- Ω		
Ifc=--- A	ZL-PE=--- Ω		
Trcd=---ms	Ircd=---mA		
FREQ=50.00Hz	Ut=---V		
VL-PE=231V	VL-N=232V		
30mA		500V	1.00MΩ
IΔn	Type	Vtest	Lim

- Press the **GO/STOP** key on the instrument or the **START** key on remote lead. The

instrument will start the automatic test sequence.



### CAUTION

If message “**Measuring...**” appears on the display, the instrument is performing measurement. During this whole stage, do not disconnect the test leads of the instrument from the mains

6. The **Ra** test starts and the screen to the side appears on the display. After **approx. 20s** the **Ra** ends and instantaneously the values of **Z<sub>L-N</sub>**, **Z<sub>L-PE</sub>**, **I<sub>scMin</sub>**, **I<sub>FCMin</sub>** appears on the display.

In case of **positive** result of the all test sequentially performed as **Ra** (**Z<sub>L-N</sub>** and **Z<sub>L-PE</sub>** < **199Ω**) the instrument proceed with progress of the test on the trip-out current and trip-out time of the RCD

AUTO	15/10 – 18:04		
TN	> φ <		
I <sub>sc</sub> =1437A Z <sub>L-N</sub> = 0.16Ω			
I <sub>fc</sub> =1277A Z <sub>L-PE</sub> =0.18Ω			
Trcd=---ms Ircd=---mA			
FREQ=50.00Hz Ut=---V			
VL-PE=231V VL-N=232V			
<b>Measuring...</b>			
30mA		500V	1.00MΩ
I <sub>Δn</sub>	Type	V <sub>test</sub>	Lim

7. The **RCD** test starts and the screen to the side appears on the display. The trip-out current and the trip-out time values appears on the display.

In case of **positive** result of the all test sequentially performed during RCD test (**Trcd** and **Ircd** parameters) (see § 12.4) the instrument proceed with progress of the test on insulation resistance between L-N, L-PE and N-PE conductors

AUTO	15/10 – 18:04		
TN	> φ <		
I <sub>sc</sub> =1437A Z <sub>L-N</sub> = 0.16Ω			
I <sub>fc</sub> =1277A Z <sub>L-PE</sub> =0.18Ω			
Trcd=25ms Ircd=27.0mA			
FREQ=50.00Hz Ut=1.5V			
VL-PE=231V VL-N=232V			
<b>Measuring...</b>			
30mA		500V	1.00MΩ
I <sub>Δn</sub>	Type	V <sub>test</sub>	Lim

8. The insulation test starts and the screen to the side appears on the display. The **RL-N**, **RL-PE** and **RN-PE** values appears on the display.

In case of **positive** result of the all test sequentially performed during insulation test (insulation resistance > minimum limit threshold) the instrument finish the “OK” message is shown and the screen to the side is displayed by the instrument

AUTO	15/10 – 18:04		
TN	> φ <		
RL-N	>999MΩ	Vt= 523V	
RL-PE	>999MΩ	Vt= 524V	
RN-PE	>999MΩ	Vt=522V	
FREQ	=50.00Hz	Ut=1.5V	
VL-PE	=0V	VL-N=0V	
<b>&lt; OK &gt;</b>			
30mA		500V	1.00MΩ
I <sub>Δn</sub>	Type	V <sub>test</sub>	Lim

Press the (◀, ▶) in order to show the values of the second available page



9. In case of **negative** result of the **Ra<sub>±</sub>** test (**Z<sub>L-N</sub>** and/or **Z<sub>L-PE</sub> >199Ω**), the auto test is automatically blocked, the message “NOT OK” is shown and the screen to the side is displayed.

AUTO		15/10 – 18:04		
TN		>φ<		
Isc=1437A ZL-N= 0.16Ω				
Ifc=---A ZL-PE >199Ω				
Trcd=---ms Ircd=---mA				
FREQ=50.00Hz Ut=---V				
VL-PE=231V VL-N=232V				
◀ NOT OK ▶...				
30mA		500V	1.00MΩ	
IΔn	Type	Vtest	Lim	

10. In case of **negative** result of the **RCD test** (**Trcd >300ms** or **Ircd > 33.0mA**) the auto test is automatically blocked, the message “NOT OK” is shown and the screen to the side is displayed.

AUTO		15/10 – 18:04		
TN		>φ<		
Isc=1437A ZL-N= 0.16Ω				
Ifc=1277A ZL-PE=0.18Ω				
Trcd=>300ms Ircd >33.0mA				
FREQ=50.00Hz Ut=1.5V				
VL-N=232V VL-PE=231V				
◀ NOT OK ▶				
30mA		500V	1.00MΩ	
IΔn	Type	Vtest	Lim	

11. In case of **negative** result of the **Insulation test** (insulation resistance < minimum limit threshold) the auto test is automatically blocked, the message “NOT OK” is shown and the screen to the side is displayed

AUTO		15/10 – 18:04		
TN		>φ<		
RL-N >999MΩ Vt= 523V				
RL-PE=0.03MΩ Vt= 57V				
RN-PE >999MΩ Vt=522V				
FREQ=50.00Hz Ut=1.5V				
VL-PE=0V VL-N=0V				
◀ NOT OK ▶				
30mA		500V	1.00MΩ	
IΔn	Type	Vtest	Lim	

12. Press the **SAVE** key to store the test result in the instrument’s memory (see § 7.1) or the **ESC/MENU** key to exit the screen without saving and go back to the main measuring screen

- Press the **MENU** key, move the cursor to **AUTO** in the main menu by means of the arrow keys (**▲**, **▼**) and confirm with **ENTER**. Subsequently the instrument displays a screen similar to the one reported here to the side.

Select the “UK” country (see § 5.1.2), the options “TN”, “25 or 50V”, “50Hz or 60Hz” and the reference voltage in the general settings of the instrument (see § 5.1.3)

AUTO		15/10 – 18:04		
TT		> ◊ <		
RA=---	Ω	Ut=---	V	
Trcd=---	ms	Ircd=---	mA	
FREQ=0.00Hz		VL-PE=0V VL-N=0V		
30mA		500V	1.00MΩ	
IΔn	Type	Vtest	Lim	

- Use the **◀**, **▶** keys to select the parameter to be modified, and the **▲**, **▼** keys to modify the parameter value
  - **IΔn** → The virtual key allows setting the nominal value of the RCD’s tripping current, which may be: **6mA**, **10mA**, **30mA**
  - **Type** → The virtual key enables the selection of the RCD type, which may be: **AC** () or **A** ()
  - **Vtest** → This key allows to select the DC test voltage generated during the measurement. The following values are available: **50V**, **100V**, **250V**, **500V**, **1000V**
  - **Lim** → This key allows the selection of the minimum limit threshold in order to consider the insulation measurement correct. The following values are available: **0.05MΩ**, **0.10MΩ**, **0.23MΩ**, **0.25MΩ**, **0.50MΩ**, **1.00MΩ**, **100MΩ**

### CAUTION



- Make sure to select the correct value when setting the RCD’s test current. If setting a current higher than the nominal current of the device being tested, the RCD would be tested at a current higher than the correct one, thus facilitating a faster tripping of the switch
- The “> ◊ <” symbol indicate that the test cables or the cable with shuko plug is just calibrated in the LOOP section (see § 6.7). The AUTO function is referred to this value

- Insert the green, blue and black connectors of the three-pin shuko cable into the corresponding input leads B1, B3 and B4 of the instrument. As an alternative, use the single cables and apply the relevant alligator clips to the free ends of the cables. It is also possible to use the remote lead by inserting its multipolar connector into the input lead B1. Connect the shuko plug, the alligator clips or the remote lead to the electrical mains according to Fig. 4 or Fig. 5
- Note the correct voltage values between L-N and L-PE as shown in the screen to the side

AUTO		15/10 – 18:04		
TT		> ◊ <		
RA=---	Ω	Ut=---	V	
Trcd=---	ms	Ircd=---	mA	
FREQ=50.00Hz		Ut=---V		
VL-PE=231V		VL-N=232V		
30mA		500V	1.00MΩ	
IΔn	Type	Vtest	Lim	

- Press the **GO/STOP** key on the instrument or the **START** key on remote lead. The instrument will start the automatic test sequence.

## CAUTION



If message “**Measuring...**” appears on the display, the instrument is performing measurement. During this whole stage, do not disconnect the test leads of the instrument from the mains

6. The **Ra** test starts and the screen to the side appears on the display. After **approx. 20s** the **Ra** ends and instantaneously the values of **RA** (overall earth resistance) and **Ut** (contact voltage) appears on the display.

In case of **positive** result of the **Ra** test (see § 12.8) the instrument proceed with progress of the test on the trip-out current and trip-out time of the RCD

AUTO		15/10 – 18:04		▶◀
TT				▶◀
RA=48.8 Ω		Ut=1.5 V		
Trcd=---ms		Ircd=---mA		
FREQ=50.00Hz		VL-PE=231V VL-N=232V		
Measuring...				
30mA	~	500V	1.00MΩ	
IΔn	Type	Vtest	Lim	

7. The **RCD** test starts and the screen to the side appears on the display. The trip-out current and the trip-out time values appears on the display.

In case of **positive** result of the all test sequentially performed during RCD test (**Trcd** and **Ircd** parameters) (see § 12.4) the instrument proceed with progress of the test on insulation resistance between L-N, L-PE and N-PE conductors

AUTO		15/10 – 18:04		▶◀
TT				▶◀
RA=48.8 Ω		Ut=1.5 V		
Trcd=25ms		Ircd=27.0mA		
FREQ=50.00Hz		VL-PE=231V VL-N=232V		
Measuring...				
30mA	~	500V	1.00MΩ	
IΔn	Type	Vtest	Lim	

8. The insulation test starts and the screen to the side appears on the display. The RL-N, RL-PE and RN-PE values appears on the display.

In case of **positive** result of the all test sequentially performed during insulation test test (insulation resistance > minimum limit threshold) the instrument finish the “OK” message is shown and the screen to the side is displayed by the instrument

Press the (◀, ▶) in order to show the values of the second available page

AUTO		15/10 – 18:04		▶◀
TT				▶◀
RL-N	>999MΩ	Vt=	523V	
RL-PE	>999MΩ	Vt=	524V	
RN-PE	>999MΩ	Vt=	522V	
FREQ=50.00Hz		VL-PE=0V VL-N=0V		
◀ OK ▶				
30mA	~	500V	1.00MΩ	
IΔn	Type	Vtest	Lim	

9. In case of **negative** result of the **Ra** test (see § 12.8),

AUTO		15/10 – 18:04		▶◀
------	--	---------------	--	----

the auto test is automatically blocked, the message “NOT OK” is shown and the screen to the side is displayed.

TT <span style="float: right;">&gt;φ&lt;</span>			
RA=1824 Ω Ut=54.7 V			
Trcd=---ms Ircd=---mA			
FREQ=50.00Hz			
VL-PE=231V VL-N=232V			
◀ NOT OK ▶...			
30mA		500V	1.00MΩ
IΔn	Type	Vtest	Lim

10. In case of **negative** result of the **RCD test (Trcd >300ms or Ircd > 33.0mA)** the auto test is automatically blocked, the message “NOT OK” is shown and the screen to the side is displayed.

AUTO 15/10 – 18:04 <span style="float: right;">■</span>			
TT <span style="float: right;">&gt;φ&lt;</span>			
RA=48.8 Ω Ut=1.5 V			
Trcd=>300ms Ircd >33.0mA			
FREQ=50.00Hz			
VL-PE=231V VL-N=232V			
◀ NOT OK ▶			
30mA		500V	1.00MΩ
IΔn	Type	Vtest	Lim

11. In case of **negative** result of the **Insulation test** (insulation resistance < minimum limit threshold) the auto test is automatically blocked, the message “NOT OK” is shown and the screen to the side is displayed

AUTO 15/10 – 18:04 <span style="float: right;">■</span>			
TT <span style="float: right;">&gt;φ&lt;</span>			
RL-N >999MΩ Vt= 523V			
RL-PE=0.03MΩ Vt= 57V			
RN-PE >999MΩ Vt=522V			
FREQ=50.00Hz Ut=1.5V			
VL-PE=0V VL-N=0V			
◀ NOT OK ▶			
30mA		500V	1.00MΩ
IΔn	Type	Vtest	Lim

12. Press the **SAVE** key to store the test result in the instrument’s memory (see § 7.1) or the **ESC/MENU** key to exit the screen without saving and go back to the main measuring screen

### 6.1.1. Anomalous situations

1. If the instrument detects an L-N or L-PE voltage higher than the maximum limit (265V), it does not carry out the test and displays a screen like the one to the side. Check the connection of measuring cables

AUTO		15/10 – 18:04		
TN				
Isc=---	A	ZL-N=---	Ω	
Ifc=---	A	ZL-PE=---	Ω	
Trcd=---ms Ircd=---mA				
FREQ=50.00Hz Ut=---V				
VL-PE=270V VL-N=272V				
<b>Voltage &gt; 265V</b>				
30mA		500V	1.00MΩ	
IΔn	Type	Vtest	Lim	

2. If the instrument detects an L-N or L-PE voltage lower than the minimum limit (100V), it does not carry out the test and displays a screen like the one to the side. Check that the system being tested is supplied

AUTO		15/10 – 18:04		
TN				
Isc=---	A	ZL-N=---	Ω	
Ifc=---	A	ZL-PE=---	Ω	
Trcd=---ms Ircd=---mA				
FREQ=50.00Hz Ut=---V				
VL-PE=15V VL-N=15V				
<b>Voltage &lt; 100V</b>				
30mA		500V	1.00MΩ	
IΔn	Type	Vtest	Lim	

3. If the instrument detects that the phase and neutral leads are inverted, it does not carry out the test and a screen similar to the one reported to the side is displayed. Rotate the Mains Plug or check the connection of measuring cables

AUTO		15/10 – 18:04		
TN				
Isc=---	A	ZL-N=---	Ω	
Ifc=---	A	ZL-PE=---	Ω	
Trcd=---ms Ircd=---mA				
FREQ=--- Hz Ut=---V				
VL-PE=--- V VL-N=--- V				
<b>Exchange L-N</b>				
30mA		500V	1.00MΩ	
IΔn	Type	Vtest	Lim	

4. If the instrument detects a danger voltage on PE conductor, it does not carry out the test and displays a screen like the one to the side

AUTO		15/10 – 18:04		
TN				
Isc=---	A	ZL-N=---	Ω	
Ifc=---	A	ZL-PE=---	Ω	
Trcd=---ms Ircd=---mA				
FREQ=--- Hz Ut=---V				
VL-PE=--- V VL-N=--- V				
<b>Voltage on PE</b>				
30mA		500V	1.00MΩ	
IΔn	Type	Vtest	Lim	

## 6.2. DMM: DIGITAL MULTIMETER FUNCTION

This function allows to read the real time TRMS values of P-N Voltage, P-PE Voltage, N-PE Voltage and Frequency (@ P-N inputs) when the instrument is connected to an installation.

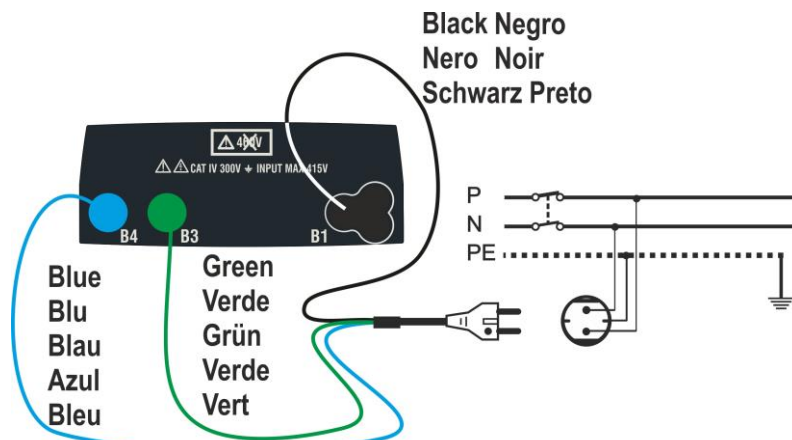

Fig. 6: Instrument connection through Mains Plug

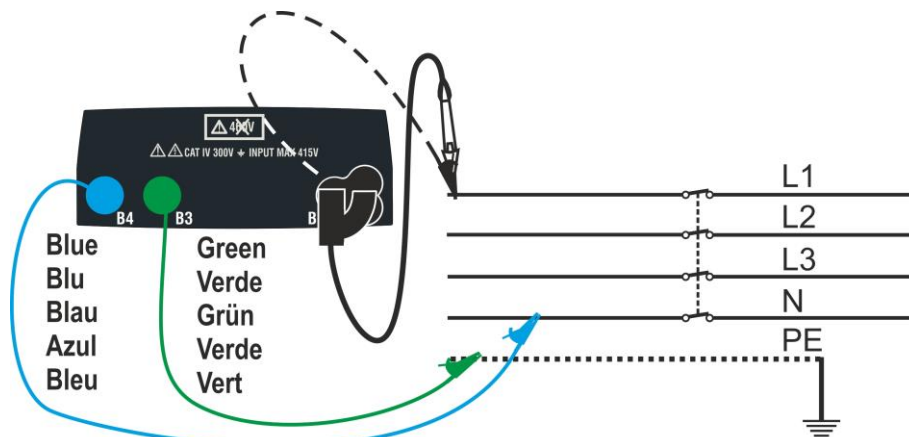

Fig. 7: Instrument connection by means of single cables and remote lead

1. Press the **MENU** key, move the cursor to **DMM** in the main menu by means of the arrow keys (**▲**, **▼**) and confirm with **ENTER**. Subsequently the instrument displays a screen similar to the one reported here to the side.

DMM		15/10 – 18:04	
FREQ.	= 0.00	Hz	
VL-N	= 0	V	
VL-PE	= 0	V	
VN-PE	= 0	V	

2. Insert the green, blue and black connectors of the three-pin shuko cable into the corresponding input leads B1, B3 and B4 of the instrument. As an alternative, use the single cables and apply the relevant alligator clips to the free ends of the cables. It is also possible to use the remote lead by inserting its multipolar connector into the input lead B1. Connect the shuko plug, the alligator clips or the remote lead to the electrical mains according to Fig. 6 or Fig. 7

3. The TRMS values of L-N voltage, L-PE voltage, N-PE voltage and the frequency of L-N voltage is show on the display.

Press **GO/STOP** key to enable/disable the "HOLD" function in order to fix the value on the display.

DMM	15/10 – 18:04	
FREQ.	= 50.00	Hz
VL-N	= 230	V
VL-PE	= 230	V
VN-PE	= 2	V
<b>HOLD</b>		



### CAUTION

This data cannot be saved in the internal memory

### 6.3. RPE: CONTINUITY OF PROTECTIVE CONDUCTORS

This function is performed in compliance with standards IEC/EN61557-4, BS7671 17th/18th edition and allows measuring the resistance of protective and equipotential conductors.



#### CAUTION

- The instrument can be used for measurements on installations with overvoltage category CAT IV 300V to earth and max 415V between inputs
- We recommend holding the alligator clip respecting the safety area created by the hand protection (see § 4.2).
- Check that no voltage is present at the ends of the item to be tested before carrying out a continuity test.  
The results may be influenced by the presence of auxiliary circuits connected in parallel with the item to be tested or by transient currents.

The following operating modes are available:

- **STD** the test is activated by pressing the **GO/STOP** key (or **START** on the remote lead). Recommended mode
- **TMR** the user can set a sufficiently long time to be able to move the tip on the conductors being examined while the instrument performs the test. For all the duration of the measurement the instrument emits a short acoustic signal every 3 seconds elapsed. The user shall touch the metal part under test while the instrument beeps. If, during the measurement, a result assumes a value higher than the set limit, the instrument emits a continuous acoustic signal. To stop the test, press the **GO/STOP** key or the **START** key on the remote lead again
- **>φ<** Compensation of the resistance of the cables used for measurement. The instrument automatically subtracts the value of cable resistance from the measured resistance value. **Therefore, it is necessary that this value is measured (by the >φ< function) each time the measuring cables are changed or extended**



#### CAUTION

Continuity test is carried out by supplying a current higher than 200mA in case the resistance does not exceed ca. 5Ω (including resistance of the test cables). For higher resistance values, the instrument carries out the test with a current lower than 200mA.

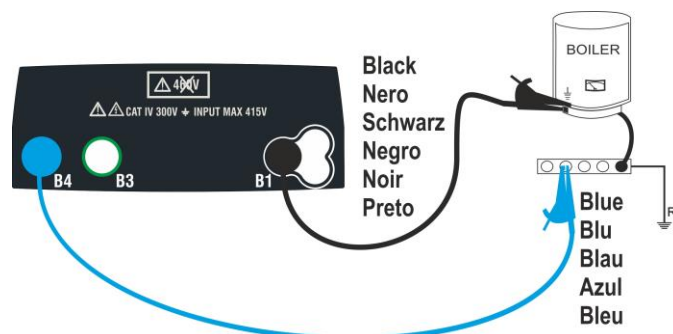

Fig. 8: Continuity test by means of single cables



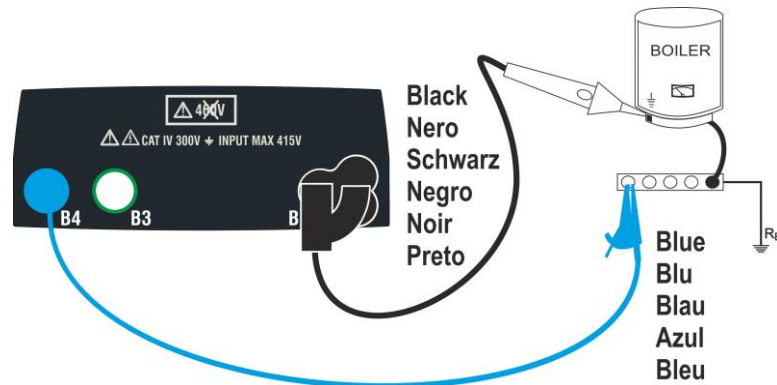

Fig. 9: Continuity test by means of remote lead

1. Press the **MENU** key, move the cursor to **RPE** in the main menu by means of the arrow keys (**▲**, **▼**) and confirm with **ENTER**. Subsequently the instrument displays a screen similar to the one reported here to the side.

RPE	15/10 – 18:04	■
R	=	--- Ω
I test	=	--- mA
STD	2.00Ω	--- Ω
<b>MODE</b>	Lim	> φ <

2. Use the **◀**, **▶** keys to select the parameter to be modified, and the **▲**, **▼** keys to modify the parameter value:
  - **MODE** → this virtual key allows setting the test mode. The following options are available: **STD**, **TMR**
  - **Lim** → this virtual key allows the selection of the maximum limit to consider the measured value correct. It is possible to set a limit included in the range: **0.01Ω ÷ 9.99Ω** in passi da 0.01Ω
  - **Time (TMR mode)** → this virtual key allows you to set the duration of the measurement in the range: **3s ÷ 99s** in passi da 3s
3. Insert the blue and black connectors of the single cables into the corresponding input leads B4 and B1 of the instrument. Apply the relevant alligator clips to the free ends of the cables. It is also possible to use the remote lead by inserting its multipolar connector into the input lead B1
4. Should the length of the cables provided be insufficient for the measurement to be performed, extend the blue cable
5. Select the **> φ <** mode to compensate the resistance of the cables used for measuring according to the instructions given in 6.3.2

### CAUTION



Before connecting the test leads, make sure that there is no voltage at the ends of the conductor to be tested.

6. Connect the test leads to the ends of the conductor to be tested as in Fig. 8 o Fig. 9

### CAUTION



Always make sure, before any test, that the compensation resistance value of the cables is referred to the cables currently used. In case of doubt, repeat the cable calibration procedure as in § 6.3.2

7. Press the **GO/STOP** key on the instrument or the **START** key on remote lead. The instrument will start the measurement

**CAUTION**

If message "**Measuring...**" appears on the display, the instrument is performing measurement. During this whole stage, do not disconnect the test leads of the instrument from the conductor under test

8. At the end of the measurement the instrument shows on the display the message "OK" in case of a positive result (value lower than the set limit threshold) or "NOT OK" in case of negative result (value higher than the set limit threshold)

RPE	15/10 – 18:04		
R	=	0.22 Ω	
I <sub>test</sub>	=	212 mA	
<b>OK</b>			
STD	2.00Ω	0.21 Ω	
MODE	Lim		> φ <

### 6.3.1. TMR mode

1. With the arrow keys (▲, ▼) select the "TMR" option in the "**Mode**" section. The instrument displays a screen like the one shown to the side, set the measurement duration in the "**Time**" section and follow the steps from point 2 to point 6 of § 6.2

RPE	15/10 – 18:04		
R	=	- - - Ω	
I <sub>test</sub>	=	- - - mA	
T	=	- - - s	
TMR	2.00Ω	12s	- - - Ω
MODE	Lim	Time	> φ <

2. Press **GO/STOP** key on the instrument or the **START** key on the remote lead. The instrument starts a series of continuous measurements for the entire duration set with a countdown by giving a short beep every 3 seconds and alternating the words "**Measuring...**" and "**Please wait...**"

RPE	15/10 – 18:04		
R	=	0.23 Ω	
I <sub>test</sub>	=	209 mA	
T	=	11 s	
<b>Please wait...</b>			
TMR	2.00Ω	12s	0.01 Ω
MODE	Lim	Time	> φ <

3. At the end of the set duration time, the instrument shows

RPE	15/10 – 18:04		
-----	---------------	--	--

on the display the maximum value between all the partial measurements performed and the message "OK" in case of a positive result (value lower than the set limit threshold) or "NOT OK" in case of negative result (value higher than the set limit threshold)

R	=	0.54	Ω
I <sub>test</sub>	=	209	mA
T	=	0	s
<b>OK</b>			
TMR	2.00Ω	12s	0.01 Ω
<b>MODE</b>	Lim	Time	> φ <

- Press the **SAVE** key to store the test result in the instrument's memory (see § 7.1) or the **ESC/MENU** key to exit the screen without saving and go back to the main measuring screen

### 6.3.2. > φ < mode

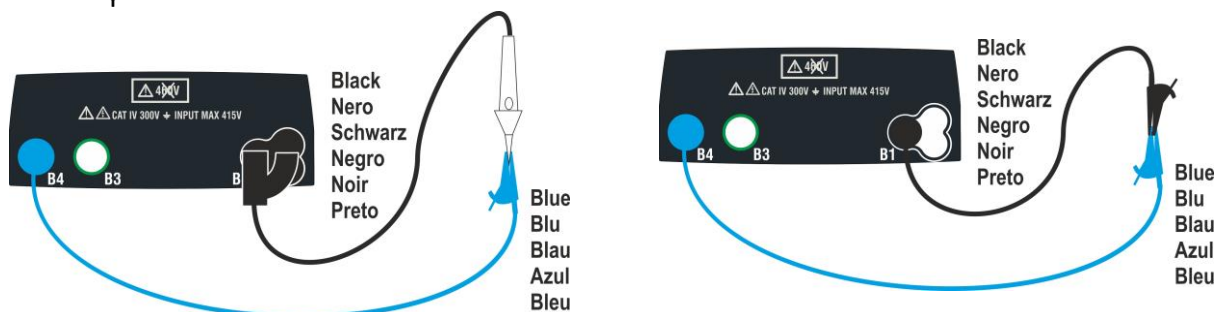

Fig. 10: Compensation of single cables and remote lead resistance

- Use the ◀, ▶ keys to select the the virtual key > φ <
- Connect the alligator clips and/or test leads and/or remote probe to the conductor to be tested as in in Fig. 10.
- Press the **GO/STOP** key on the instrument or the **START** key on remote lead. The instrument starts the calibration procedure of the cables immediately followed by the verification of the compensated value

### CAUTION



If message "Measuring..." appears on the display, the instrument is performing measurement. If message "Verify" appears on the display, the instrument is verifying the calibrated value. During this whole stage, do not unshort the test leads of the instrument.

- Once calibration is comple-ted, in case the detected value is lower than 5Ω, the instrument gives a double acoustic signal which signals the positive result of the test and displays a screen similar to the one reported here to the side

RPE	15/10 – 18:04	
R	=	- - - Ω
I <sub>test</sub>	=	- - - mA
STD	2.00Ω	0.01 Ω
<b>MODE</b>	Lim	> φ <

- In order to delete the compensation resistance value of the cables, it is necessary to perform a cable calibration procedure with a resistance higher than 5Ω at test leads (e.g. with open test leads).

### 6.3.3. Anomalous situations

1. In case the detected value is higher than the set limit, the instrument gives a long acoustic signal and displays a screen similar to the one reported here to the side

RPE	15/10 – 18:04	■
R	=	4.54 $\Omega$
Itest	=	212 mA
<b>NOT OK</b>		
STD	2.00 $\Omega$	0.01 $\Omega$
MODE	Lim	> $\phi$ <

2. If the instrument detects a resistance higher than the full scale it emits a prolonged acoustic signal and displays a screen like the one to the side

RPE	15/10 – 18:04	■
R	=	>1999 $\Omega$
Itest	=	- - - mA
<b>NOT OK</b>		
STD	2.00 $\Omega$	0.01 $\Omega$
MODE	Lim	> $\phi$ <

3. By using the > $\phi$ < mode, in case the instrument detects a calibration reset (performing the operation with open terminals), it gives out a long sound and displays a screen like the one to the side

RPE	15/10 – 18:04	■
R	=	- - - $\Omega$
Itest	=	- - - mA
<b>Zero Reset</b>		
STD	2.00 $\Omega$	- - - $\Omega$
MODE	Lim	> $\phi$ <

4. By using the > $\phi$ < mode, the instrument detects at its terminals a resistance higher than 5 $\Omega$  emits a prolonged acoustic signal, resets the compensated value and displays a screen like the one to the side

RPE	15/10 – 18:04	■
R	=	- - - $\Omega$
Itest	=	- - - mA
<b>Calib. not OK</b>		
STD	2.00 $\Omega$	- - - $\Omega$
MODE	Lim	> $\phi$ <

5. If the instrument detects at its terminals a voltage higher than 3V it does not perform the test, it emits a prolonged acoustic signal and displays a screen like the one on the side

RPE	15/10 – 18:04	■
R	=	- - - $\Omega$
Itest	=	- - - mA
<b>Vin &gt; 3V</b>		
STD	2.00 $\Omega$	- - - $\Omega$
MODE	Lim	> $\phi$ <

#### 6.4. $Lo\Omega$ : CONTINUITY OF PROTECTIVE CONDUCTORS WITH 10A

This function allows measuring the resistance of protective and equipotential conductors with a test current  $>10A$  by using **the 16230 optional accessory** connected to the instrument through the C2050 cable. The 16230 must be directly powered by the mains on which measurements are performed. For detailed information, please refer to the user manual of the accessory 16230.



### CAUTION

- The instrument can be used for measurements on installations with overvoltage category CAT IV 300V to earth and max 415V between inputs
- We recommend holding the alligator clip respecting the safety area created by the hand protection (see § 4.2).
- Check that no voltage is present at the ends of the item to be tested before carrying out a continuity test.  
The results may be influenced by the presence of auxiliary circuits connected in parallel with the item to be tested or by transient currents
- Continuity test is carried out by supplying a current **higher than 10A** in case the resistance does not exceed ca.  $0.7\Omega$  (including resistance of the test cables). **The 4-wire method allows to extend the test leads without any preliminary calibration**

1. Press the **MENU** key, move the cursor to  **$Lo\Omega$**  in the main menu by means of the arrow keys (**▲**, **▼**) and confirm with **ENTER**. Subsequently the instrument displays a screen similar to the one reported here to the side.

$Lo\Omega$	15/10 – 18:04	
R	= - - - $\Omega$	
$I_{test}$	= - - - A	
0.500 $\Omega$		
Lim.	INFO	

2. Use the **▲**, **▼** keys to modify the parameter value **Lim** → this virtual key allows the selection of the maximum limit to consider the measured value correct. It is possible to set a limit included in the range:  **$0.003\Omega \div 0.500\Omega$**  in steps of  $0.001\Omega$

3. Connect the 16230 accessory to the main supply (230/240V – 50/60Hz) and note the switch on of LED green. Connect the accessory to the instrument through the C2050 cable. Subsequently the “Conn.” message is shown indicating the correct detection by the instrument

$Lo\Omega$	15/10 – 18:04	
R	= - - - $\Omega$	
$I_{test}$	= - - - A	
0.500 $\Omega$ Conn.		
Lim.	INFO	

4. Use the ◀, ▶ keys to select the "INFO" item. The screen to the side is shown on the display indicating the information relative to 16230 accessory

LoΩ	15/10 – 18:04	■
LOW 10A		
SN:	20090011	
FW:	1.00	
HW:	1.00	
CalDate:	15/01/21	
Status:	Connected	
0.500 Ω Conn.		
Lim.	INFO	

5. Connect the alligator clips to the conductor to be tested as indicated in **Fejl! Henvisningskilde ikke fundet..**

6. Press the **GO/STOP** key on the instrument. The instrument will start the measurement. At the end of the measurement the instrument shows on the display the message "OK" in case of a positive result (value lower than the set limit threshold) or "NOT OK" in case of negative result (value higher than the set limit threshold)

LoΩ	15/10 – 18:04	■
R	= 0.328 Ω	
Itest	= 14.76 A	
OK		
0.500 Ω Conn.		
Lim.	INFO	

7. Press the **SAVE** key to store the test result in the instrument's memory (see § 7.1) or the **ESC/MENU** key to exit the screen without saving and go back to the main measuring screen

### 6.4.1. Anomalous situations

1. If the instrument detects at its terminals a voltage higher than 3V it does not perform the test, it emits a prolonged acoustic signal and displays a screen like the one on the side

LoΩ		15/10 – 18:04		
R	=	- - -	Ω	
I <sub>test</sub>	=	- - -	A	
<b>V<sub>in</sub> &gt; 3V</b>				
0.500 Ω		Conn.		
Lim.	INFO			

2. If the instrument not detects the 16230 accessory displays a screen like the one on the side. Check the connections with the accessory

LoΩ		15/10 – 18:04		
R	=	- - -	Ω	
I <sub>test</sub>	=	- - -	A	
<b>16230 not detected</b>				
0.500 Ω		Conn.		
Lim.	INFO			

3. The instrumen shows on the display the message "**NOT OK**" in case of a positive result (value lower than the set limit threshold) but with test current lower than 10A as indicated in the screen like the one on the side

LoΩ		15/10 – 18:04		
R	=	0.119	Ω	
I <sub>test</sub>	=	8.05	A	
<b>NOT OK</b>				
0.500Ω		Conn.		
Lim.	INFO			

### 6.5. MΩ: MEASUREMENT OF INSULATION RESISTANCE

This function is performed in compliance with standards IEC/EN61557-2, BS7671 17th/18th edition and allows measuring the insulation resistance between the active conductors and between each active conductor and the earth. The following operating modes are available:

- **MAN** the test can be carried out between the L-N, L-PE or N-PE conductors and has a fixed duration of 3s when the **GO/STOP** key is pressed on the instrument (or **START** on the remote lead). Recommended mode
- **TMR** the test is carried out between the L-PE conductors and has a programmable duration in the **3s ÷ 999s** range in steps from 1s to the pressing of the **GO/STOP** key on the instrument (or **START** of the remote lead). It is possible to perform **DAR** (Dielectric Absorption Ratio) duration test for test time >60s and **PI** (Polarization Index) for test time > 600s (10min)
- **AUTO** the instrument performs an automatic sequence test between the L-N, L-PE and N-PE conductors when the **GO/STOP** key is pressed on the instrument (or **START** of the remote lead)

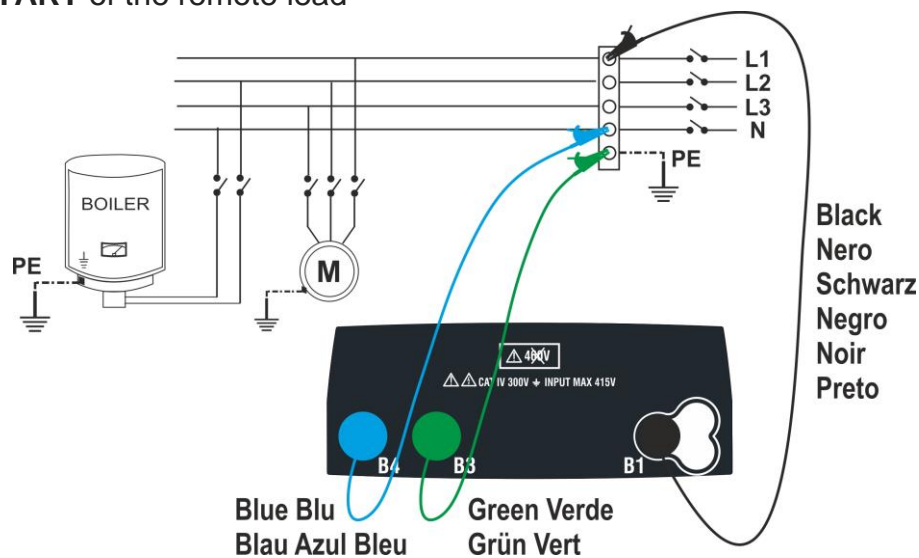

Fig. 11: Insulation test between L-N-PE by means of single cables(MAN and AUTO modes)

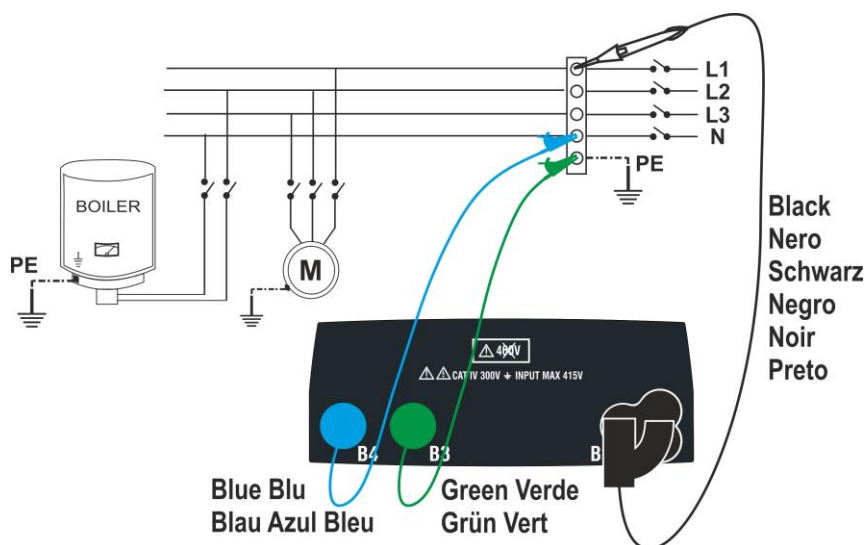

Fig. 12: Insulation between L-N-PE with single cables and remote lead (MAN and AUTO)



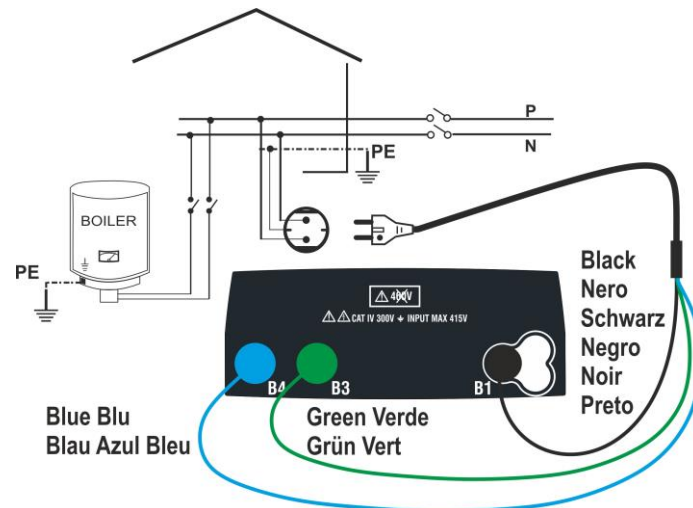

Fig. 13: Insulation between L-N-PE by means of Mains plug (MAN and AUTO)

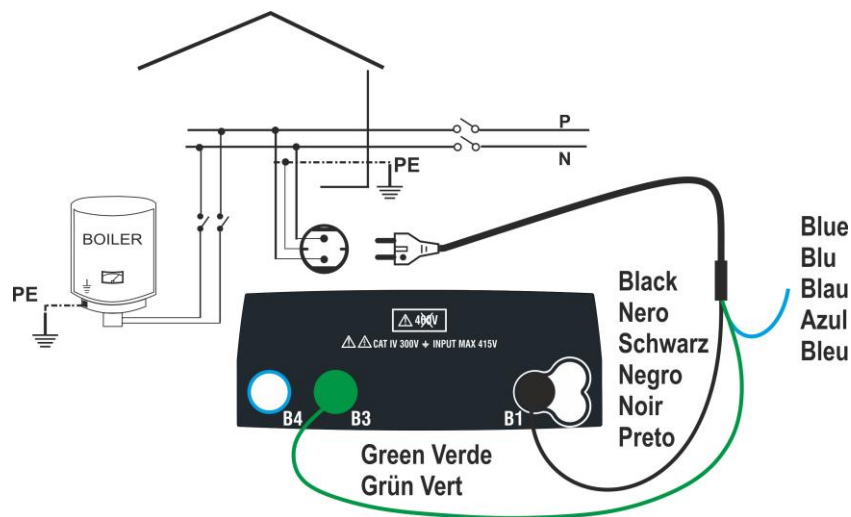

Fig. 14: Insulation between L-PE by means of Mains plug (TMR mode)

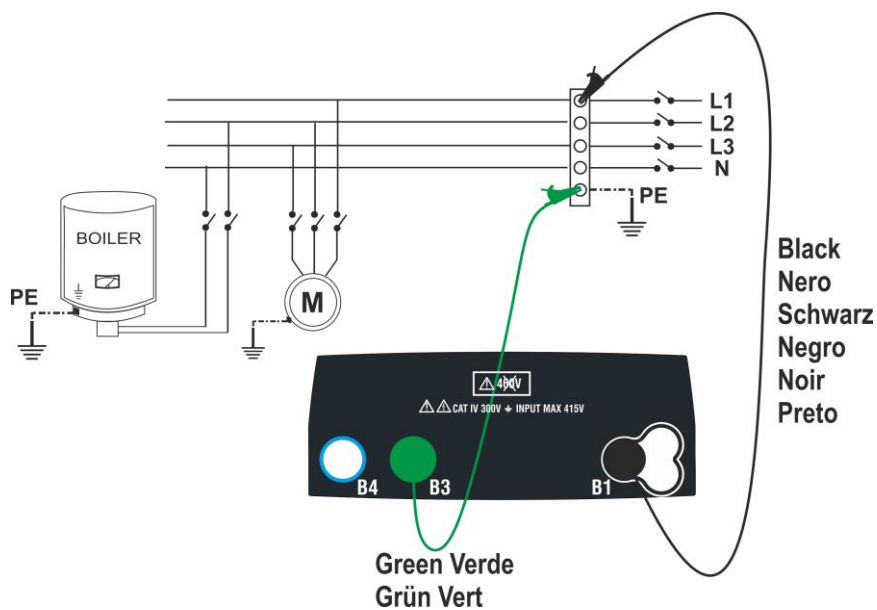

Fig. 15: Insulation between L-PE by means of single cables (TMR mode)

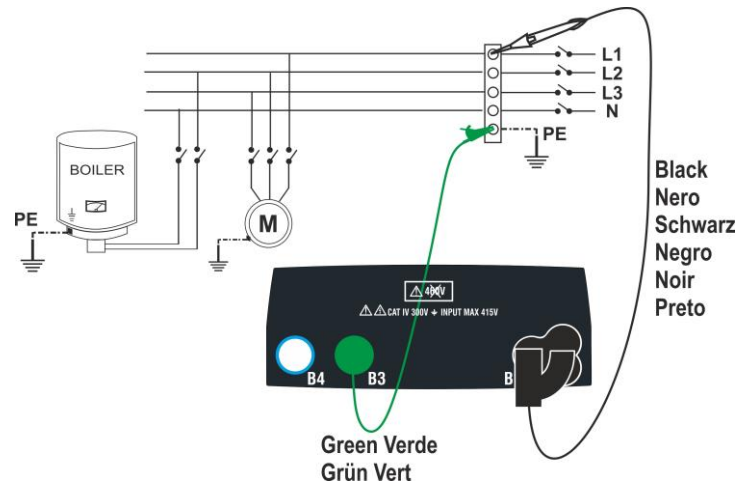

Fig. 16: Insulation between L-PE by means of single cable and remote lead (TMR mode)

1. Press the **MENU** key, move the cursor to **MΩ** in the main menu by means of the arrow keys (▲, ▼) and confirm with **ENTER**. Subsequently the instrument displays a screen similar to the one reported here to the side

M.Ω	15/10 – 18:04		
R	=	- - -	M.Ω
Vt	=	- - -	V
T	=	- - -	s
MAN	500V	1.00MΩ	L-PE
<b>MODE</b>	Vtest	Lim.	<b>FUNC</b>

2. Use the ◀, ▶ keys to select the parameter to be modified, and the ▲, ▼ keys to modify the parameter value:
  - **MODE** → This key allows setting the test mode. The following options are available: **MAN, TMR, AUTO**
  - **Vtest** → This key allows to select the DC test voltage generated during the measurement. The following values are available: **50V, 100V, 250V, 500V, 1000V**
  - **Lim** → This key allows the selection of the minimum limit threshold in order to consider the measurement correct. The following values are available: **0.05MΩ, 0.10MΩ, 0.23MΩ, 0.25MΩ, 0.50MΩ, 1.00MΩ, 100MΩ**
  - **FUNC** → This key allows to set the connection type L-N, L-PE or N-PE in MAN mode
  - **Temp** → only in TMR mode, this virtual key allows to set the duration time of test in the range: **3s ÷ 999s**
3. We suggest setting the value of the voltage supplied while measuring and the minimum limit to consider the measure correct according to the prescriptions of the reference standard (see § 12.2)
4. Insert the green and black connectors of the single cables into the corresponding input leads B1, B3, B4 (MAN and AUTO modes) or B1, B3 (TMR mode) of the instrument. Apply the relevant alligator clips to the free ends of the cables. It is also possible to use the remote lead by inserting its multipolar connector into the input lead B1. Should the length of the cables provided be insufficient for the measurement to be performed, extend the green cable

### CAUTION



- Disconnect any cable not strictly involved in measurement
- Before connecting the test leads, make sure that there is no voltage at the ends of the conductors to be tested

5. Connect the test leads and remote lead to the ends of the conductors to be tested as Fig. 11, Fig. 12, Fig. 13, Fig. 14, Fig. 15, or Fig. 16
6. Press the **GO/STOP** key for few seconds on the instrument or the **START** key on remote lead. The instrument will start the measurement

### CAUTION



If message "**Measuring...**" appears on the display, the instrument is performing measurement. During this whole stage, do not disconnect the test leads of the instrument from the conductors under test, as the circuit being tested could remain charged with a dangerous voltage due to the stray capacitances of the system

7. Regardless of the operating mode selected, the instrument, at the end of each test, applies a resistance to the output leads to discharge the stray capacitances in the circuit

8. At the end of the measurement (fixed duration of 3s) the instrument shows on the display the message "**OK**" in case of a positive result (value higher than the set minimum limit threshold) or "**NOT OK**" in case of negative result (value lower than the minimum limit threshold set). The indication "**>999MΩ**" indicates the out of scale of the instrument which, normally, appears to be the best possible result

MΩ	15/10 – 18:04			
R	>	999 MΩ		
Vt	=	512 V		
T	=	3	s	
<b>OK</b>				
MAN	500V	1.00MΩ	L-PE	
MODE	Vtest	Lim.	FUNC	

9. Press the **SAVE** key to store the test result in the instrument's memory (see § 7.1) or the **ESC/MENU** key to exit the screen without saving and go back to the main measuring screen

### 6.5.1. TMR mode

- With the arrow keys ( $\blacktriangle$ ,  $\blacktriangledown$ ) select the "TMR" option in the "Mode" section. The instrument displays a screen like the one shown on the side. Set the duration of the measurement in the "Time" section and follow the steps from point 2 to point 5 of § 6.4

MΩ	15/10 – 18:04		
R	=	---	MΩ
Vt = --- V		T = --- s	
PI = ---		DAR = ---	
TMR	500V	1.00MΩ	10s
MODE	Vtest	Lim.	Time

- Press the **GO/STOP** key for few seconds on the instrument or the **START** key on the remote lead. The instrument starts the measurement for the entire duration set showing the "Measuring..." message. The instrument shows the message "OK" on the display in case of a positive result (value higher than the set minimum threshold) or "NOT OK" in case of negative result (value lower than the minimum limit set)

MΩ	15/10 – 18:04		
R	=	102	MΩ
Vt = 523V		T = 10 s	
PI = ---		DAR = ---	
OK			
TMR	500V	1.00MΩ	10s
MODE	Vtest	Lim.	Time

- With a measurement duration  $\geq 60s$  the instrument shows the indication of the DAR parameter (Dielectric Absorbtion Ratio) as shown in the screen to the side

MΩ	15/10 – 18:04		
R	=	102	MΩ
Vt = 523V		T = 60 s	
PI = ---		DAR = 1.03	
OK			
TMR	500V	1.00MΩ	60s
MODE	Vtest	Lim.	Time

- With a measurement duration  $\geq 600s$  the instrument shows the indication of the DAR parameter (Dielectric Absorbtion Ratio) and of the PI parameter (Polarisation Index) as shown in the screen to the side

MΩ	15/10 – 18:04		
R	=	102	MΩ
Vt = 523V		T = 600 s	
PI = 1.00		DAR = 1.03	
OK			
TMR	500V	1.00MΩ	600s
MODE	Vtest	Lim.	Time

### 6.5.2. AUTO mode

- With the arrow keys (**▲**, **▼**) select the "AUTO" option in the "**Mode**" section. The instrument displays a screen like the one shown on the side. Set the duration of the measurement in the "**Time**" section and follow the steps from point 2 to point 5 of § 6.4.

The instrument performs the insulation test between: L-N, L-PE and N-PE. Since some loads could be still connected between L-N, the instrument performs a preliminary test by using 50V as test voltage. If the RL-N is higher than 50kΩ a new insulation test between L-N is performed by using the Vtest value. Finally the instrument performs L-PE and N-PE insulation test

MΩ	15/10 – 18:04		
RL-N	= --- MΩ	Vt = --- V	
RL-PE	= --- MΩ	Vt = --- V	
RN-PE	= --- MΩ	Vt = --- V	
AUTO	500V	1.00MΩ	
<b>MODE</b>	Vtest	Lim.	

- Press the **GO/STOP** key on the instrument or the **START** key on the remote lead. The instrument starts the automatic sequential measurement of the insulation resistance between L-N, L-PE and N-PE respectively by showing the "**Measuring...**" message. the instrument shows the message "**OK**" on the display in case of positive result of each test (value higher than the set minimum limit threshold) or "**NOT OK**" in case of negative result of at least one test (value lower than the set minimum limit threshold)

MΩ	15/10 – 18:04		
RL-N	> 999 MΩ	Vt = 523 V	
RL-PE	= 250 MΩ	Vt = 525 V	
RN-PE	> 999 MΩ	Vt = 524 V	
<b>OK</b>			
AUTO	500V	1.00MΩ	
<b>MODE</b>	Vtest	Lim.	

- Press the **SAVE** key to store the test result in the instrument's memory (see § 7.1) or the **ESC/MENU** key to exit the screen without saving and go back to the main measuring screen

### 6.5.3. Anomalous situations

1. If the instrument fails to generate the nominal voltage, it emits a long acoustic signal to indicate the negative result of the test and displays a screen like the one on the side

MΩ	15/10 – 18:04		
R	=	0.01	MΩ
Vt	=	0	V
T	=	3	s
<b>NOT OK</b>			
MAN	500V	1.00MΩ	L-PE
<b>MODE</b>	Vtest	Lim.	FUNC

2. At the end of the test, if the measured resistance value is lower than the set limit, the instrument emits a long acoustic signal to indicate the negative result of the test and displays a screen like the one on the side

MΩ	15/10 – 18:04		
R	=	0.29	MΩ
Vt	=	534	V
T	=	3	s
<b>NOT OK</b>			
MAN	500V	1.00MΩ	L-PE
<b>MODE</b>	Vtest	Lim.	FUNC

3. In AUTO mode if the insulation measurement L-N is  $<50\text{k}\Omega = 0.05\text{M}\Omega$ , all the tests are completed or if the **STOP** key has been pressed, if  $\text{RL-PE}$  and  $\text{RN-PE} > \text{Lim}$  and  $\text{Vt} > \text{Vnom}$  the instrument shows the screen like the one on the side. Disconnect the loads and resume the test

MΩ	15/10 – 18:04		
RL-N	=	0.01MΩ	Vt = 15 V
RL-PE	>	999 MΩ	Vt = 525 V
RN-PE	>	999 MΩ	Vt = 524 V
<b>Not OK – Check loads</b>			
AUTO	500V	1.00MΩ	
<b>MODE</b>	Vtest	Lim.	



4. At the end of the test, if the value of the test voltage is lower than the nominal value, the instrument displays a screen like the one on the side

MΩ	15/10 – 18:04		
R	=	0.12	MΩ
Vt	=	485	V
T	=	3	s
<b>Vtest not correct</b>			
MAN	500V	1.00MΩ	L-PE
<b>MODE</b>	Vtest	Lim.	FUNC

5. If the instrument detects at its terminals a voltage **higher than 10V** it does not perform the test, it emits a prolonged acoustic signal and displays a screen like the one on the side

MΩ	15/10 – 18:04			
R	=	- - -	MΩ	
Vt	=	- - -	V	
T	=	- - -	s	
<b>Vin &gt;10V</b>				
MAN	500V	1.00MΩ	L-PE	
<b>MODE</b>	Vtest	Lim.	FUNC	

## 6.6. RCD: TEST ON DIFFERENTIAL SWITCHES

This function is performed in compliance with standard IEC/EN61557-6, BS7671 17th/18th edition and allows measuring the tripping time and current of molded case differential switches of type A () and AC () being General (G) and Selective (S).

### CAUTION





The instrument performs the check of voltage on PE by comparing the voltage at B4 input and the ground potential induced on instrument side by mean the user's hand, so in order to check voltage on PE, **it's mandatory to hold the instrument case on the left or on the right side**

### CAUTION



Some combinations of test parameters can be not available in compliance with the technical specification of the instrument and the RCD tables (see § 10.1 – the empty cells of RCD tables means not available situations)

The following operating modes are available:

- **AUTO** the instrument performs tripping time measurement automatically with a leakage current equal to half, once or five times the set value of nominal current and with a leakage current in phase with the positive (+) and negative (-) half-wave of the mains voltage. Recommended mode for RDC test
- **AUTO**  the instrument performs tripping time measurement automatically with a leakage current equal to half, once or five times the set value of nominal current and with a leakage current in phase with the positive (+) and negative (-) half-wave of the mains voltage and also real tripping current
- **x $\frac{1}{2}$**  the instrument performs tripping time measurement with a leakage current equal to half the set value of nominal current with the positive (+) and negative (-) half-wave of the mains voltage
- **x1** the instrument performs tripping time measurement with a leakage current equal to once the set value of nominal current with the positive (+) and negative (-) half-wave of the mains voltage
- **x5** the instrument performs tripping time measurement with a leakage current equal to five times the set value of nominal current with the positive (+) and negative (-) half-wave of the mains voltage
-  the instrument performs measurement with an increasing leakage current. This test could be performed to determine the real tripping current of the RCD with the positive (+) and negative (-) half-wave of the mains voltage

### CAUTION



Testing an RCD causes the RCD's tripping. **Therefore, check that there are NO users or loads connected downstream of the RCD being tested which could be damaged by a system downtime.**

If possible, disconnect all loads connected downstream of the RCD as they could produce leakage currents further to those produced by the instrument, thus invalidating the results of the test.



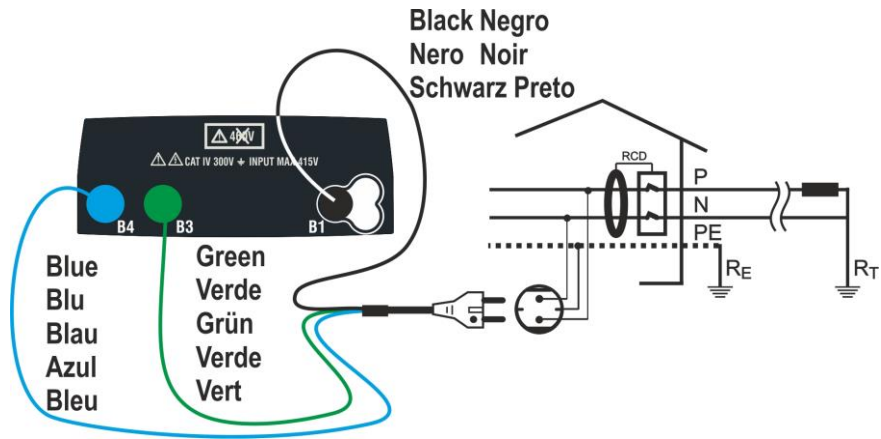

Fig. 17: Connection for single-phase 230V system by means of Mains Plug

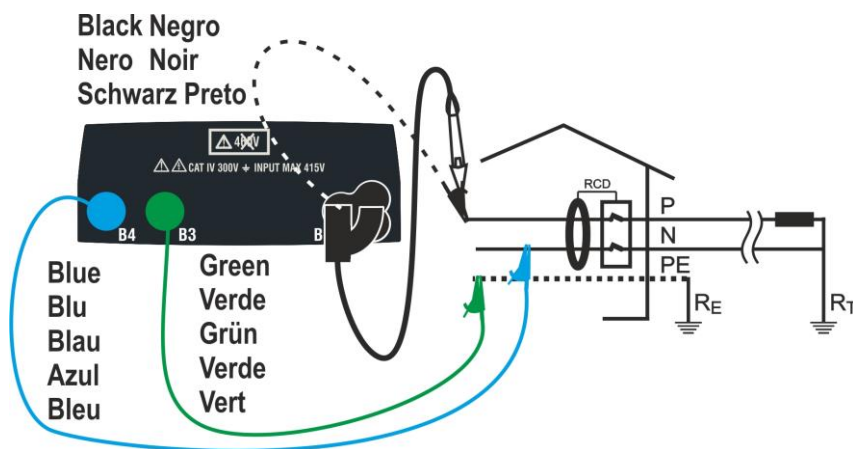

Fig. 18: Connection for single-phase 230V system with single cables and remote lead

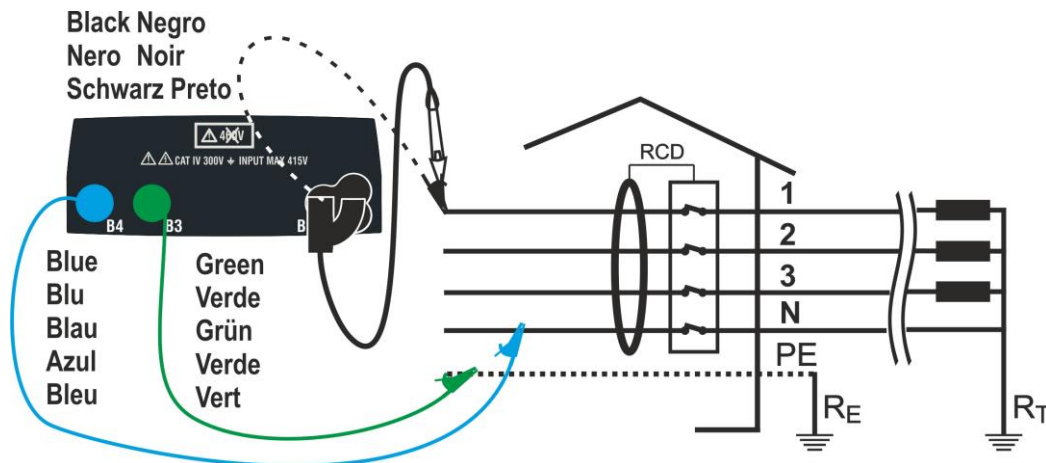

Fig. 19: Connection for 400V + N + PE three-phase system by means of single cables and remote lead

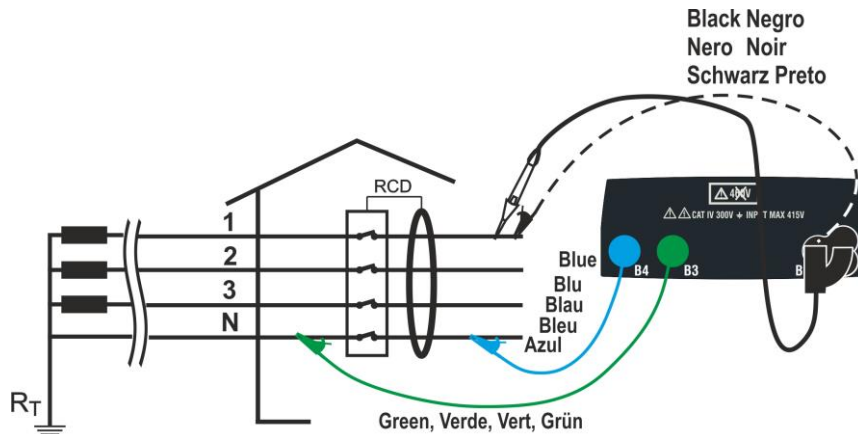

Fig. 20: Connection for a 400V + N (no PE) three-phase system by means of single cables and remote lead

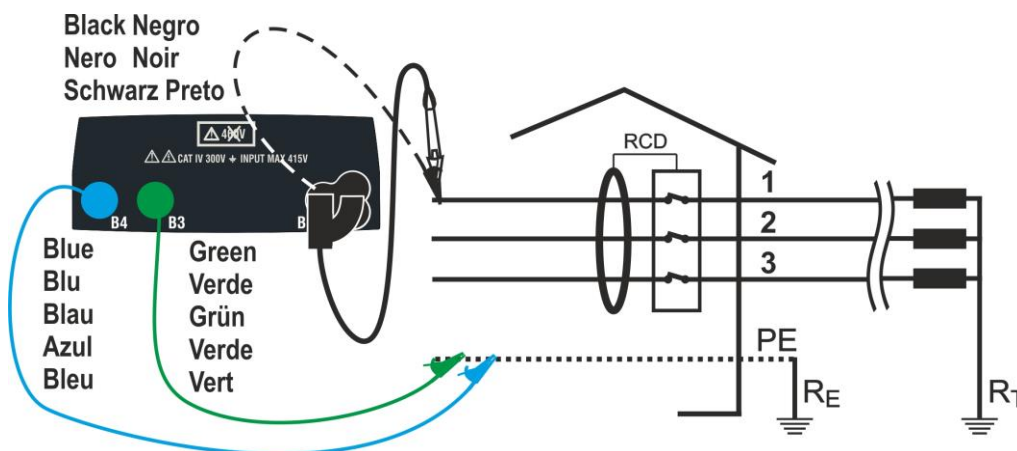

Fig. 21: Connection for a 400V + PE (no N) system with single cables and remote lead

1. Press the **MENU** key, move the cursor to **RCD** in the main menu by means of the arrow keys (**▲**, **▼**) and confirm with **ENTER**. Subsequently the instrument displays a screen similar to the one reported here to the side.

Select the “UK” country (see § 5.1.2), the options “TN, TN or IT”, “25 or 50V”, “50Hz or 60Hz” and the reference voltage in the general settings of the instrument (see § 5.1.3).

RCD	15/10 – 18:04	■	
TT			
T	= ---	ms	
Ut	= ---	V	
FREQ.	= 0.00Hz		
VL-PE=0V	VL-N=0V		
X1	30mA	~+	
MODE	IΔn	Type	Ut

2. Use the **◀**, **▶** keys to select the parameter to be modified, and the **▲**, **▼** keys to modify the parameter value:
  - **MODE** → The virtual key allows setting the measuring mode of the instrument, which may be: **AUTO**, **x<sup>1/2</sup>**, **x1**, **x5**, **■**
  - **IΔn** → The virtual key allows setting the nominal value of the RCD's tripping current, which may be: **6mA**, **10mA**, **30mA**, **100mA**, **300mA**, **500mA**, **650mA**, **1000mA**
  - **Type** → The virtual key enables the selection of the RCD type, which may be: **AC** (⌚), **ACS** (⌚S), **A** (M), **AS** (MS) with polarity positive (+) or negative (-)
  - **Ut** → The virtual key allows setting the possible visualization of the contact voltage value at the end of measurement. Options: **Ut** or **NoUt**

- Insert the green, blue and black connectors of the three-pin shuko cable into the corresponding input leads B3, B4 and B1 of the instrument. As an alternative, use the single cables and apply the relevant alligator clips to the free ends of the cables. It is also possible to use the remote probe by inserting its multipolar connector into the input lead B1. Connect the shuko plug, the alligator clips or the remote probe to the electrical mains according to Fig. 17, Fig. 18, Fig. 19, Fig. 20, Fig. 21
- Note the correct voltage values between L-N and L-PE as shown in the screen to the side

RCD	15/10 – 18:04	■	
TT			
T	=	---	ms
Ut	=	---	V
FREQ. = 50.00Hz			
VL-PE=232V		VL-N=231V	
X1	30mA	~+	
MODE	IΔn	Type	Ut

### 6.6.1. AUTO mode

- Press the **GO/STOP** key on the instrument, the **START** key on remote lead or the AutoStart feature (see § 5.1.5). The instrument will start the measurement

RCD	15/10 – 18:04	■	
TT			
	0°	180°	
X1	38ms	---ms	
X5	---ms	---ms	
X½	---ms	---ms	
FREQ=50.00Hz Ut=---V			
VL-N=232V		VL-PE=231V	
Measuring...			
AUTO	30mA	~	
MODE	IΔn	Type	Ut

## CAUTION



If message **“Measuring...”** appears on the display, the instrument is performing measurement. During this whole stage, do not disconnect the test leads of the instrument from the mains.

- The **AUTO** mode foresees the automatic execution of 6 measurements in a sequence:
  - IdN x 1 with phase 0° (the RCD must trip, reset the switch, message “Resume RCD” is shown)
  - IdN x 1 with phase 180° (the RCD must trip, reset the switch, message “Resume RCD” is shown)
  - IdN x 5 with phase 0° (the RCD must trip, reset the switch, message “Resume RCD” is shown)
  - IdN x 5 with phase 180° (the RCD must trip, reset the switch, message “Resume RCD” is shown)
  - IdN x ½ with phase 0° (RCD must not trip)
  - IdN x ½ with 180° (RCD must not trip, end test)

RCD	15/10 – 18:04	■	
TT			
	0°	180°	
X1	38ms	---ms	
X5	---ms	---ms	
X½	---ms	---ms	
FREQ=50.00Hz Ut=---V			
VL-N=232V		VL-PE=231V	
Resume RCD			
AUTO	30mA	~	
MODE	IΔn	Type	Ut

7. In case of **positive** result (all tripping times comply with what indicated in 12.4) of the all test sequentially performed the “OK” message is shown and the screen to the side is displayed by the instrument.

RCD	15/10 – 18:04			
TN	0°	180°		
X1	38ms	35ms		
X5	22ms	27ms		
X½	>999ms	>999ms		
FREQ=50.00Hz Ut=0.0V				
VL-N=232V VL-PE=231V				
OK				
AUTO	30mA			
MODE	IΔn	Type	Ut	

8. Press the **SAVE** key to store the test result in the instrument’s memory (see § 7.1) or the **ESC/MENU** key to exit the screen without saving and go back to the main measuring screen

### 6.6.2. AUTO mode

5. Press the **GO/STOP** key on the instrument, the **START** key on remote lead or the AutoStart feature (see § 5.1.5). The instrument will start the measurement

RCD	15/10 – 18:04			
TT	0°	180°		
	---	mA	---	mA
X1	---	ms	---	ms
X5	---	ms	---	ms
X½	---	ms	---	ms
FREQ.=50.0Hz Ut = - - - V				
VL-PE= 231V VL-N = 232V				
Measuring...				
AUTO		30mA		
MODE	IΔn	Type	Ut	

## CAUTION



If message “**Measuring...**” appears on the display, the instrument is performing measurement. During this whole stage, do not disconnect the test leads of the instrument from the mains.

6. The **AUTO** mode foresees the automatic execution of 8 measurements in a sequence:

- (Ramp) with phase 0° (the RCD must trip, reset the switch, message “Resume RCD” is shown)
- (Ramp) with phase 180° (the RCD must trip, reset the switch, message “Resume RCD” is shown)
- IdN x 1 with phase 0° (the RCD must trip, reset the switch, message “Resume RCD” is shown)
- IdN x 1 with phase 180° (the RCD must trip, reset the switch, message “Resume RCD” is shown)
- IdN x 5 with phase 0° (the RCD must trip, reset the switch, message “Resume RCD” is shown)
- IdN x 5 with phase 180° (the RCD must trip, reset the switch, message “Resume RCD” is shown)
- IdN x½ with phase 0° (RCD must not trip)
- IdN x½ with 180° (RCD must not trip, end test)

RCD	15/10 – 18:04			
TT	0°	180°		
	23	mA	---	mA
X1	---	ms	---	ms
X5	---	ms	---	ms
X½	---	ms	---	ms
FREQ.=50.0Hz Ut = - - - V				
VL-PE= 231V VL-N = 232V				
Resume RCD.				
AUTO		30mA		
MODE	IΔn	Type	Ut	

7. In case of **positive** result (all tripping times comply with

RCD	15/10 – 18:04			
-----	---------------	--	--	--

what indicated in 12.4) of the all test sequentially performed the “OK” message is shown and the screen to the side is displayed by the instrument

TT	0°	180°		
	23	mA	23	mA
X1	23	ms	23	ms
X5	15	ms	15	ms
X½	>999	ms	>999	ms
FREQ.=50.0Hz		Ut = 1 V		
VL-PE= 231V		VL-N = 232V		
<b>OK.</b>				
AUTO.	30mA			
<b>MODE</b>	IΔn	Type	Ut	

- Press the **SAVE** key to store the test result in the instrument’s memory (see § 7.1) or the **ESC/MENU** key to exit the screen without saving and go back to the main measuring screen

### 6.6.3. x½, x1, x5 modes

- Press the **GO/STOP** key on the instrument, the **START** key on remote lead or the AutoStart feature (see § 5.1.5). The instrument will start the measurement

RCD	15/10 – 18:04		
TT			
T	=	---	ms
Ut	=	---	V
FREQ. = 0.00Hz			
VL-PE=0V		VL-N=0V	
<b>Measuring...</b>			
X1	30mA		
<b>MODE</b>	IΔn	Type	Ut



## CAUTION

If message “**Measuring...**” appears on the display, the instrument is performing measurement. During this whole stage, do not disconnect the test leads of the instrument from the mains.

- When the RCD trips and separates the circuit, if the tripping time is within the limits reported in 12.4, the instrument gives a double acoustic signal which signals the “OK” message is shown and the screen to the side is displayed by the instrument

RCD	15/10 – 18:04		
TT			
T	=	38	ms
Ut	=	1	V
FREQ. = 50.00Hz			
VL-PE=231V		VL-N=234V	
<b>OK</b>			
X1	30mA		
<b>MODE</b>	IΔn	Type	Ut

- Press the **SAVE** key to store the test result in the instrument’s memory (see § 7.1) or the **ESC/MENU** key to exit the screen without saving and go back to the main measuring screen

#### 6.6.4. mode

The standard defines the tripping times for RCDs at nominal current. The mode is used to detect the tripping time at tripping current (which could also be lower than the nominal voltage).

- Press the **GO/STOP** key on the instrument, the **START** key on remote lead or the AutoStart feature (see § 5.1.5). The instrument will start the measurement

RCD 15/10 – 18:04			
TT			
I = --- mA			
T = --- ms Ut = --- V			
FREQ. = 50.00Hz			
VL-PE=231V VL-N=234V			
Measuring...			
30mA			
MODE	IΔn	Type	Ut



### CAUTION

If message “**Measuring...**” appears on the display, the instrument is performing measurement. During this whole stage, do not disconnect the test leads of the instrument from the mains.

- According to standard EN61008, the test for selective RCDs requires an interval of 60 seconds between the tests. **The mode is therefore unavailable for selective RCDs, both of A and of AC type.**
- When the RCD trips and separates the circuit, if the tripping current and tripping time are within the limits reported in 12.4, the instrument gives a double acoustic signal which signals the “**OK**” message is shown and the screen to the side is displayed by the instrument

RCD 15/10 – 18:04			
TT			
I = 24 mA			
T = 38 ms Ut = 1 V			
FREQ. = 50.00Hz			
VL-PE=231V VL-N=234V			
OK			
30mA			
MODE	IΔn	Type	Ut

- Press the **SAVE** key to store the test result in the instrument’s memory (see § 7.1) or the **ESC/MENU** key to exit the screen without saving and go back to the main measuring screen

### 6.6.5. Anomalous situations

1. If the instrument detects a frequency higher than the maximum limit (63Hz), it does not carry out the test and displays a screen like the one to the side

RCD	15/10 – 18:04		
TT			
T	=	---	ms
Ut	=	---	V
FREQ. = >63Hz			
VL-PE=231V VL-N=234V			
<b>Freq. out of range</b>			
X1	30mA		
<b>MODE</b>	IΔn	Type	Ut

2. If the instrument detects an L-N or L-PE voltage lower than the minimum limit (100V), it does not carry out the test and displays a screen like the one to the side. Check that the system being tested is supplied

RCD	15/10 – 18:04		
TT			
T	=	---	ms
Ut	=	---	V
FREQ. = 0.00 Hz			
VLPE=<100V VL-N=<100V			
<b>Voltage &lt;100V</b>			
X1	30mA		
<b>MODE</b>	IΔn	Type	Ut

3. If the instrument detects an L-N or L-PE voltage higher than the maximum limit (265V), it does not carry out the test and displays a screen like the one to the side. Check the connection of measuring cables

RCD	15/10 – 18:04		
TT			
T	=	---	ms
Ut	=	---	V
FREQ. = 50.00 Hz			
VLPE=>265V VL-N=>265V			
<b>Voltage &gt;265V</b>			
X1	30mA		
<b>MODE</b>	IΔn	Type	Ut

4. If the instrument detects a dangerous voltage on PE conductor it provides the warning screen shown to the side and blocks the execution of the tests. Check the PE conductor and earth plant efficiency

RCD	15/10 – 18:04		
TT			
T	=	---	ms
Ut	=	---	V
FREQ. = 0.00Hz			
VL-PE=- - -V VL-N=- - -V			
<b>Voltage on PE</b>			
X1	30mA		
<b>MODE</b>	IΔn	Type	Ut

5. If the instrument detects that the phase L and neutral N leads are inverted, it does not carry out the test and a screen similar to the one reported to the side is displayed. Rotate the Mains Plug or check the connection of measuring cables

RCD	15/10 – 18:04		
TT			
T	=	---	ms
Ut	=	---	V
FREQ. = 50.00Hz			
VL-PE= 1V		VL-N=231V	
<b>Exchange L-N</b>			
X1	30mA	~+	
<b>MODE</b>	IΔn	Type	Ut

6. If the instrument detects that the phase and PE leads are inverted, it does not carry out the test and a screen similar to the one reported to the side is displayed. Check the connection of measuring cables

RCD	15/10 – 18:04		
TT			
T	=	---	ms
Ut	=	---	V
FREQ. = 50.00Hz			
VL-PE=231V		VL-N=1V	
<b>Exchange L-PE</b>			
X1	30mA	~+	
<b>MODE</b>	IΔn	Type	Ut

7. If the instrument detects the absence of the signal to terminal B3 (PE conductor), it provides the warning screen shown to the side and blocks the execution of the tests

RCD	15/10 – 18:04		
TT			
T	=	---	ms
Ut	=	---	V
FREQ. = 50.00 Hz			
VL-PE= 114V		VL-N=231V	
<b>Missing PE</b>			
X1	30mA	~+	
<b>MODE</b>	IΔn	Type	Ut

8. If the instrument detects the absence of the signal to terminal B4 (neutral conductor), it provides the warning screen shown to the side and blocks the execution of the tests

RCD	15/10 – 18:04		
TT			
T	=	---	ms
Ut	=	---	V
FREQ. = 50.00 Hz			
VL-PE= 231V		VL-N=115V	
<b>Missing N</b>			
X1	30mA	~+	
<b>MODE</b>	IΔn	Type	Ut



9. If the instrument detects the absence of the signal to terminal B1 (phase conductor), it provides the warning screen shown to the side and blocks the execution of the tests

RCD	15/10 – 18:04	
TT		
T	= --- ms	
Ut	= --- V	
FREQ. = 50.00 Hz		
VL-PE= 0V VL-N=0V		
<b>Missing P</b>		
X1	30mA	
MODE	IΔn	Type Ut

10. If the instrument detects a dangerous contact voltage  $U_t$  (over the set limit 25V or 50V) in the starting pre-test, it provides the warning screen shown to the side and blocks the execution of the tests. Check the PE conductor and earth plant efficiency

RCD	15/10 – 18:04	
TT		
T	= --- ms	
Ut	= --- V	
FREQ. = 50.00 Hz		
VL-PE= 231V VL-N=232V		
<b>Cont. Voltage &gt; Lim</b>		
X1	30mA	
MODE	IΔn	Type Ut

11. If the RCD does not trip within the maximum duration of the test, the instrument gives a long acoustic signal which signals the negative result of the test and then displays a screen similar to the one reported here to the side. Check that the set type of RCD matches the type of RCD being tested

RCD	15/10 – 18:04	
TT		
T	= > 999 ms	
Ut	= 1 V	
FREQ. = 50.00 Hz		
VL-PE= 231V VL-N=232V		
<b>NOT OK</b>		
X1	30mA	
MODE	IΔn	Type Ut

12. If the instrument detects in the input terminals a too high external impedance such that it can not provides the nominal current, it provides the warning screen shown to the side and blocks the test. Disconnect the possible loads downstream the LCD before perform the test

RCD	15/10 – 18:04	
TT		
T	= --- ms	
Ut	= --- V	
FREQ. = 50.00 Hz		
VL-PE= 231V VL-N=232V		
<b>Ext. Impedance too high</b>		
X1	30mA	
MODE	IΔn	Type Ut

## 6.7. LOOP: LINE/LOOP IMPEDANCE AND OVERALL EARTH RESISTANCE

This function is performed in compliance with standard IEC/EN61557-3, BS7671 17th/18th edition and allows measuring the line impedance, the fault loop impedance and the prospective short-circuit current.



### CAUTION

Depending on the selected electrical system (TT, TN or IT) some kind of connection and function modes are disabled by the instruments (see Table 1)

The following operating modes are available:

- **L-N** Standard (STD) measurement of the line impedance between the phase conductor and the neutral conductor and calculation of the assumed phase-to-neutral short-circuit current
- **L-L** Standard (STD) measurement of the line impedance between the two phase conductors and calculation of the assumed phase-to-phase short-circuit current
- **L-PE** Standard (STD) measurement of the fault loop impedance between the phase conductor and the earth conductor and calculation of the assumed phase-to-earth short-circuit current
- **Ra**  $\frac{1}{3}$  Loop impedance without causing the protections tripping in TN systems (see § 12.7) and Global earth resistance (TT systems) with neutral (3-wire) and without neutral (2-wire) (see § 12.8)

### CAUTION



The instrument performs the check of voltage on PE by comparing the voltage at B4 input and the ground potential induced on instrument side by mean the user's hand, so in order to check voltage on PE, **it's mandatory to hold the instrument case on the left or on the right side**

### CAUTION



The measurement of line impedance or fault loop impedance involves the circulation of a maximum current according to the technical specifications of the instrument (see § 10.1). This could cause the tripping of possible magnetothermal or differential protections at lower tripping currents

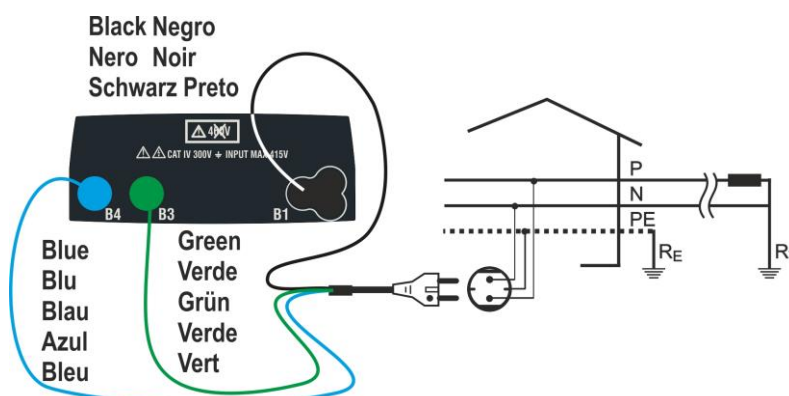

Fig. 22: P-N/P-PE test for single-phase/two-phase 230V systems with Mains Plug

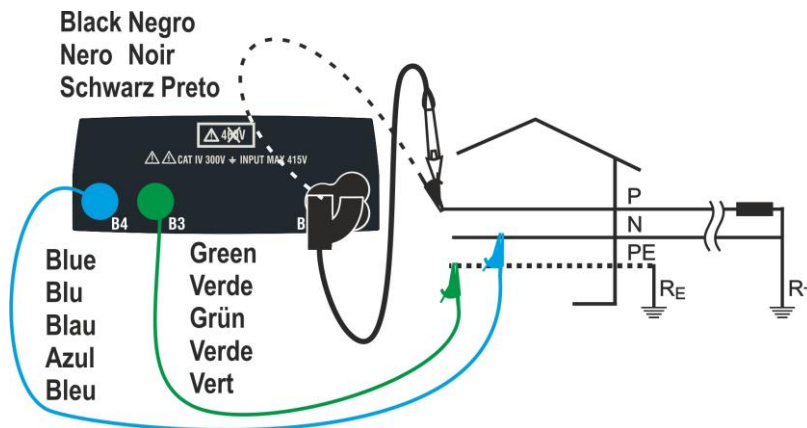

Fig. 23: P-N/P-PE test for single-phase/two-phase systems with cables and remote lead

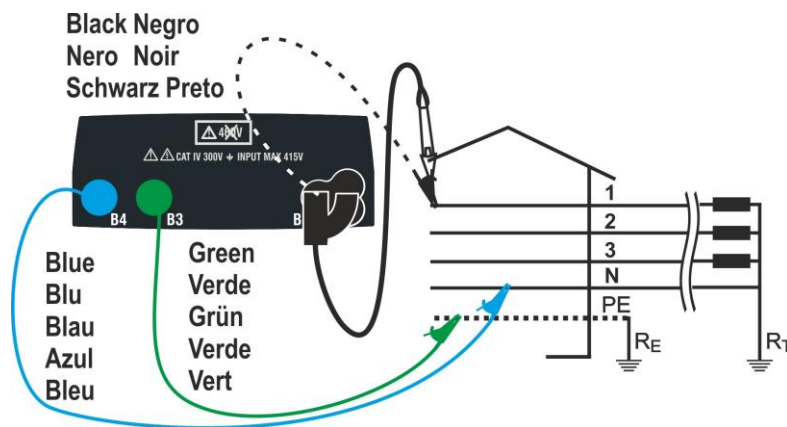

Fig. 24: P-N/P-PE test for 400V+N+PE three-phase with single cables and remote lead

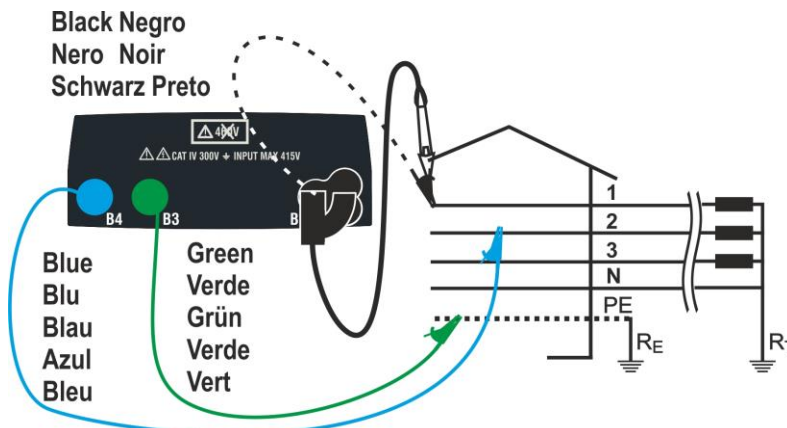

Fig. 25: P-P measurement for 400V+N+PE three-phase systems

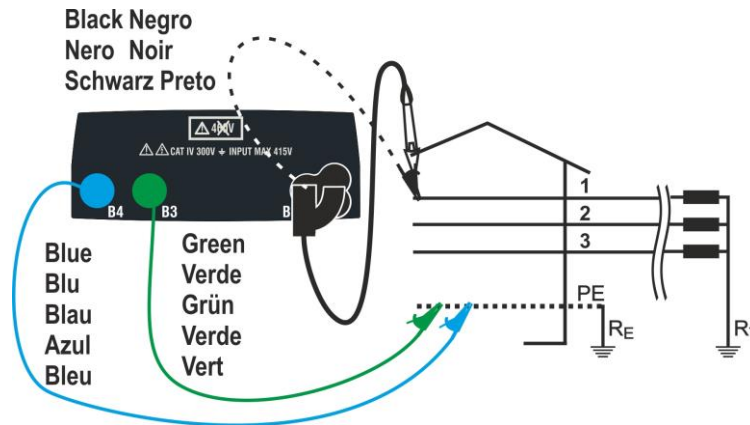

Fig. 26: P-PE/P-N test for 400V + PE systems by means of single cables and remote lead

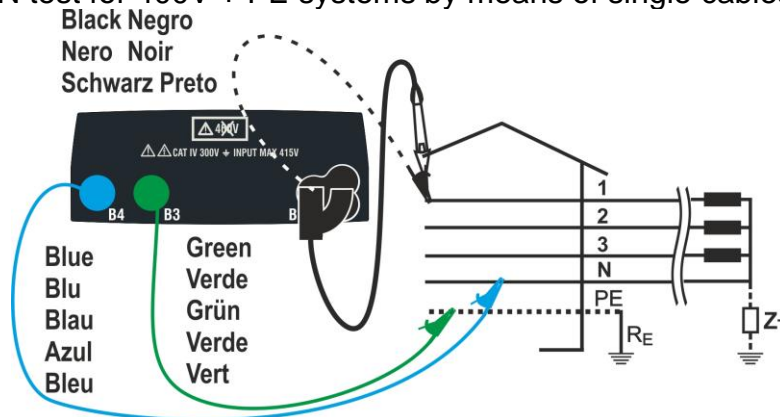

Fig. 27: P-PE measurement for IT systems by means of single cables and remote lead

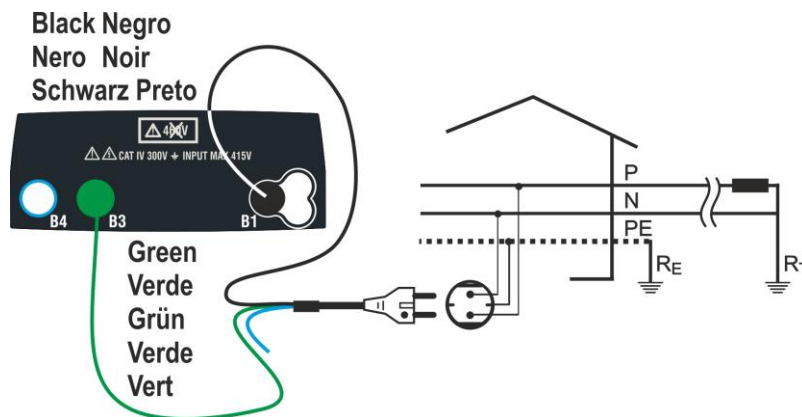

Fig. 28: P-PE 2-wire test for single-phase/two-phase 230V systems with Mains Plug

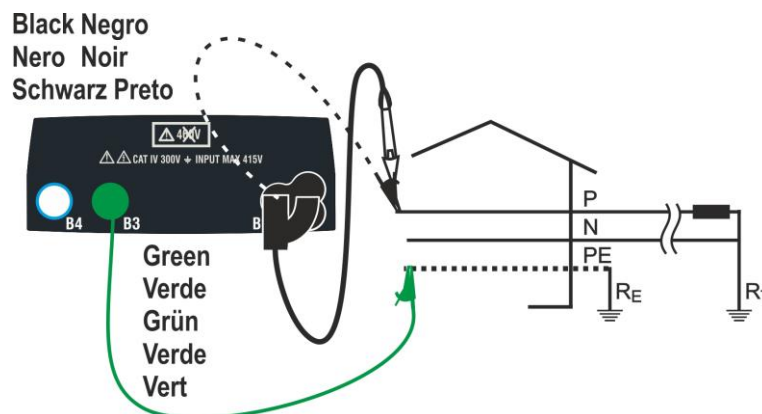

Fig. 29: P-PE 2-wire test for single-phase/two-phase systems with cables and remote lead

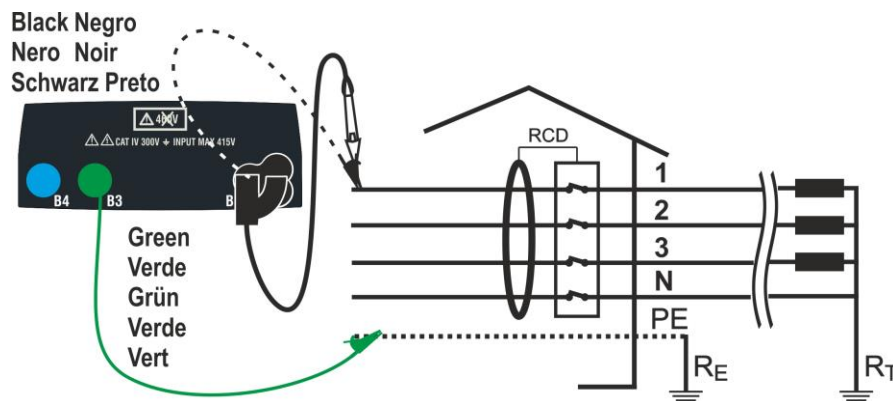

Fig. 30: P-PE 2-wire test for three-phase with single cables and remote lead

### 6.7.1. Test types

The protection of electrical lines is the essential part of a project so as to guarantee the correct functionality and avoid damages to persons or property. To this purpose, the safety guidelines impose on electrical designers also to design the electrical installation in order to reach:

1. The protection from short-circuits, that's to say the breaking capacity of the protection device must be not lower than the supposed short-circuit current in the point in which the device is installed
2. The protection from indirect contacts.

In order to verify the a.m. conditions, the instrument performs the following functions:

**Ra  $\frac{1}{3}$  (Ut) Check of protection from indirect contact** – According to the type of distribution system (TT, TN, IT) set by the user, the instrument performs the measurement and verifies the condition imposed by the guidelines. Should it be reached, the instrument gives a positive outcome (see § 12.6, 12.8, 12.9)

**Br.Cap Check of protection's breaking capacity** – The instrument detects the value of the line impedance upstream to the measurement point, calculates the maximum value of short-circuit current and gives a positive outcome if the value is lower than the limit set by the user (see § 12.5)

**TripT Check of the coordination of protections** – The instrument detects the value of the line impedance upstream to the measurement point, calculates the minimum value of short-circuit current and the corresponding value of the trip out time (t) of the protection device and gives a positive outcome if the value is lower than the limit set by the user (see § 12.10)

**STD** Generic test

The following table summarizes the possible measures executable depending on the type of system (TT, TN and IT), of selected modes and the relationships that define limit values

Mode	TT	TN	IT
	Condition x OK outcome	Condition x OK outcome	Condition x OK outcome
L-L	STD	No outcome	No outcome
	Br.Cap	Isc L-L max < BC	Isc L-L max < BC
	TripT	(IscL-Lmin 2P) → Tmax → Tmax < Tlim	(IscL-L min 2P) → Tmax → Tmax < Tlim
	Ut		(IscL-Lmin 2F) → Tmax → Tmax < Tlim
L-N	STD	No outcome	No outcome
	Br.Cap	Isc L-N max < BC	Isc L-N max < BC
	TripT	(Isc L-N min ) → Tmax → Tmax < Tlim	(Isc L-N min ) → Tmax → Tmax < Tlim
	Ut		(Isc L-N min ) → Tmax → Tmax < Tlim
L-PE	STD	No outcome	No outcome
	Br.Cap		Isc L-PE max < BC
	TripT		(I <sub>pf</sub> c L-PE min ) → Tmax → Tmax < Tlim
	Ut		ZL-PE < ZLimit (UK)
Ra 	Ut 2W	Utlim/Ra meas = Isc L-PE MIN > Idn (RCD)	ZLPEmeas < ZLIM (Table UK) ZLPEmeas < ZLIM (Table UK) Ra meas x Idn < Ut lim (**)
	Ut 3W		ZLPEmeas < ZLIM (Table UK) ZLPEmeas < ZLIM (Table UK) Ra meas x Idn < Ut lim (**)

Table 1: Conditions of positive outcome depending on the test parameters (UK country)

Where:

Empty cells	Not available mode for this particular combination of electric system
Isc L-L_Min2P	Prospective short circuit current minimum two-phase Phase-Phase
Isc L-N_Max	Prospective short circuit current maximum Phase-Neutral
Isc L-N_Min	Prospective short circuit current minimum Phase-Neutral
Isc L-PE_Max	Prospective short circuit current maximum Phase-PE
Isc L-PE_Min	Prospective short circuit current minimum Phase-PE
BC	Breaking Capacity of the protection device - kA)
Z Limit	Max allowed limit impedance compliance with type of protection
Tmax	Maximum trip out time of the protection device
Tlim	Limit time of fault extinction by the protection set by the user
Ut meas	Contact voltage measured
Ut lim	Contact voltage limit (25V or 50V)
Ra meas	Global earth resistance measured
Idn	Trip out current of RCD devices

Ip <sub>sc</sub>	Prospective short circuit current
Ip <sub>fc</sub>	Prospective fault current

### 6.7.2. Test leads calibration (ZEROLOOP)

In order to obtain better results, it is strongly recommended to perform the preliminary calibration of the test cables or the cable with Mains Plug by using the **ZEROLOOP** accessory before performing the test. In this way the instrument automatically subtracts the resistance of the test cables, providing the effective result on the display. By way of example, the procedure for the LOOP STD Generic mode is described as follows and can be extended to all other cases.

1. Press the **MENU** key, move the cursor to **LOOP** in the main menu by means of the arrow keys (**▲**, **▼**) and confirm with **ENTER**. Select the function "**CAL**". Subsequently the instrument displays a screen similar to the one reported here to the side

LOOP	15/10 – 18:04	■
TN	RL = --- Ω	
	RN = --- Ω	
	RPE = --- Ω	
	FREQ. = 0.00Hz	
	VL-PE=0V	VL-N=0V
	CAL	
	<b>FUNC</b>	

2. Insert the **ZEROLOOP** metallic accessory into the three banana connectors of the measurement cables (L-N-PE) or into the metal connectors of the Mains Plug (differently in the various types depending on the country of use) as shown in the following Table 2

Test leads	SHUKO plug	UK Mains plug	ITA plug	SWI plug	DEN plug	AUS/CHN plug	USA plug

Table 2: Connection of ZEROLOOP accessory

3. Press **GO/STOP** key to start the calibration. In the **RL**, **RN**

LOOP	15/10 – 18:04	■
TN		▶◀

and **RPE** field the resistance of test leads is shown for few seconds. This value will be automatically subtracted by the instrument at the end of Loop measurement.

The instrument displays the “▶◊◀” symbol to indicate the positive outcome of test leads calibration (**Rcal <1Ω**) and the screen to the side appears on the display.

Turn back to the measurement main screen. Note the “▶◊◀” symbol which means the successful test leads calibration and proceed with the measurements described in the following paragraphs

RL	=	0.051	Ω
RN	=	0.013	Ω
RPE	=	0.068	Ω
FREQ. = 0.00Hz			
VL-PE=0V		VL-N=0V	
<b>Zeroing OK</b>			
CAL			
<b>FUNC</b>			

4. The value of the test leads/Mains Plug resistance is maintained by the instrument up to the reset operation performed by the user (for example for the insertion of cables with different lengths).

To perform the reset of saved calibration value, remove the ZEROLOOP accessory and press **GO/STOP** key. The “▶◊◀” symbol is removed and the screen to the side appears on the display

LOOP	15/10	18:04	
TN			
RL	=	---	Ω
RN	=	---	Ω
RPE	=	---	Ω
FREQ. = 0.00Hz			
VL-PE=0V		VL-N=0V	
<b>Zero reset</b>			
CAL			
<b>FUNC</b>			



### 6.7.3. STD Mode – Generic test

This mode performs the impedance measurement and the calculation of prospective short circuit current without applying any evaluation. Therefore, at the end of the test, no outcome is given by the instrument.

1. Press the **MENU** key, move the cursor to **LOOP** in the main menu by means of the arrow keys (**▲**, **▼**) and confirm with **ENTER**. Subsequently the instrument displays a screen similar to the one reported here to the side.  
Select the “**Europe**” country (see § 5.1.2), the options “TN, TN or IT”, “25 or 50V”, “50Hz or 60Hz” and the reference voltage in the general settings of the instrument (see § 5.1.3).

LOOP	15/10 – 18:04	■
TN	Ipfc = ---	A
ZL-PE	= ---	Ω
FREQ.	= 0.00Hz	
VL-PE=0V	VL-N=0V	
L-PE	STD	
<b>FUNC</b>	MODE	

2. Use the **◀**, **▶** keys to select the parameter to be modified, and the **▲**, **▼** keys to modify the parameter value
  - **FUNC** → the virtual key allows setting the measuring mode of the instrument, which may be: **L-N**, **L-L** or **L-PE**
  - **MODE** → the virtual key allows setting the instrument’s operating mode. Select the **STD** option
3. If possible, disconnect all loads connected downstream of the measured point, as the impedance of these users could distort the test results. Perform the preliminary calibration of the test leads as described in § 6.7.2
4. Insert the green, blue and black connectors of the three-pin shuko cable into the corresponding input leads B3, B4 and B1 of the instrument. As an alternative, use the single cables and apply the relevant alligator clips to the free ends of the cables. It is also possible to use the remote lead by inserting its multipolar connector into the input lead B1. Connect the Mains Plug, the alligator clips or the remote lead to the electrical mains according to Fig. 22, Fig. 23, Fig. 24, Fig. 25 or Fig. 26
5. Note the presence of the correct voltage values between 

LOOP	15/10 – 18:04	■
------	---------------	---

L-N and L-PE corresponding to the selections carried out in the initial phase (see § 5.1.3) as shown in the screen to the side.

TN		▶◀	
Ipfc	=	---	A
ZL-PE	=	---	Ω
FREQ. = 50.00Hz			
VL-PE=231V		VL-N=232V	
L-PE	STD		
<b>FUNC</b>	<b>MODE</b>		

6. Press the **GO/STOP** key on the instrument, the **START** key on remote lead or the AutoStart feature (see § 5.1.5). The instrument will start the measurement and the “**Measuring...**” message is shown at display

LOOP		15/10 – 18:04		■
TN		▶◀		
Ipfc	=	---	A	
ZL-PE	=	---	Ω	
FREQ. = 50.00Hz				
VL-PE=231V		VL-N=232V		
<b>Measuring...</b>				
L-PE	STD			
<b>FUNC</b>	<b>MODE</b>			

7. During this whole stage, do not disconnect the measuring leads of the instrument from the system under test. The following screen appears on the instrument's display.

The value of the assumed short-circuit current (Ipfc) is shown in the upper part of the display, while the Line/Loop ZL-PE impedance is shown in the bottom part of the display.

RCD		15/10 – 18:04		■
TN		▶◀		
Ipfc	=	163	A	
ZL-PE	=	1.41	Ω	
FREQ. = 50.00Hz				
VL-PE=231V		VL-N=232V		
L-PE	STD			
<b>FUNC</b>	<b>MODE</b>			

The Standard (Std) assumed short-circuit current (Isc) is calculated using the following formulas:

$$I_{SCL-PE} = \frac{U_{NOM}}{Z_{L-PE}} \quad I_{SCL-N} = \frac{U_{NOM}}{Z_{L-N}} \quad I_{SCL-L} = \frac{\sqrt{3} U_{NOM}}{Z_{L-L}}$$

Z<sub>MEAS</sub> = measured L-L,L-N,L-PE loop impedance

U<sub>NOM</sub> = nominal voltage (depend on the system)

8. Press the **SAVE** key to store the test result in the instrument's memory (see § 7.1) or the **ESC/MENU** key to exit the screen without saving and go back to the main measuring screen

#### 6.7.4. Br.Cap mode – Verify of breaking capacity of protection device

1. Press the **MENU** key, move the cursor to **LOOP** in the main menu by means of the arrow keys (**▲**, **▼**) and confirm with **ENTER**. Subsequently the instrument displays a screen similar to the one reported here to the side.

Select the “**Europe**” country (see § 5.1.2), the options “TN, TN or IT”, “25 or 50V”, “50Hz or 60Hz” and the reference voltage in the general settings of the instrument (see § 5.1.3).

LOOP		15/10 – 18:04		■
TN				
$I_{psc}^{max}$	=	---	A	
ZL-L	=	---	$\Omega$	
FREQ. = 50.00Hz				
VL-PE=0V		VL-L=0V		
L-L	Br.Cap	15kA		
<b>FUNC</b>	<b>MODE</b>	Lim		

2. Use the **◀**, **▶** keys to select the parameter to be modified, and the **▲**, **▼** keys to modify the parameter value
  - **FUNC** → the virtual key allows setting the measuring mode of the instrument, which may be: **L-N**, **L-L** or **L-PE**
  - **MODE** → the virtual key allows setting the instrument’s operating mode. Select the **Br.Cap** option
  - **Lim** → the virtual key allows to set the maximum tripping current expressed in "kA" that the protection must interrupt in the range: **0.1kA ÷ 999kA**
3. If possible, disconnect all loads connected downstream of the measured point, as the impedance of these users could distort the test results. Perform the preliminary calibration of the test leads as described in § 6.7.2
4. Insert the green, blue and black connectors of the three-pin shuko cable into the corresponding input leads B3, B4 and B1 of the instrument. As an alternative, use the single cables and apply the relevant alligator clips to the free ends of the cables. It is also possible to use the remote lead by inserting its multipolar connector into the input lead B1. Connect the Mains Plug, the alligator clips or the remote lead to the electrical mains according to Fig. 22, Fig. 23, Fig. 24, Fig. 25 or Fig. 26
5. Note the presence of the correct voltage values between 

LOOP	15/10 – 18:04	■
------	---------------	---

L-L and L-PE corresponding to the selections carried out in the initial phase (see § 5.1.3) as shown in the screen to the side

TN		▶◀	
$I_{psc}^{max}$	=	---	A
ZL-L	=	---	$\Omega$
FREQ. = 50.00Hz			
VL-PE=223V		VL-L=387V	
L-L	Br.Cap	15kA	
<b>FUNC</b>	<b>MODE</b>	Lim	

6. Press the **GO/STOP** key on the instrument, the **START** key on remote lead or the AutoStart feature (see § 5.1.5). The instrument will start the measurement and the “**Measuring...**” message is shown at display. During this whole stage, do not disconnect the measuring leads of the instrument from the system under test. The following screen appears on the instrument's display

LOOP		15/10 – 18:04		■
TN		▶◀		
$I_{psc}^{max}$	=	---	A	
ZL-L	=	---	$\Omega$	
FREQ. = 50.00Hz				
VL-PE=223V		VL-L=387V		
<b>Measuring...</b>				
L-L	Br.Cap	15kA		
<b>FUNC</b>	<b>MODE</b>	Lim		

7. In case of **positive** result ( $I_{pscMAX} < Lim$ ) the “**OK**” outcome message is shown at display.

LOOP		15/10 – 18:04		■
TN		▶◀		
$I_{psc}^{max}$	=	3019	A	
ZL-L	=	0.16	$\Omega$	
FREQ. = 50.00Hz				
VL-PE=223V		VL-L=387V		
<b>OK</b>				
L-L	Br.Cap	6.0kA		
<b>FUNC</b>	<b>MODE</b>	Lim		

8. In case of **negative** result ( $I_{pscMAX} > Lim$ ) the “**NOT OK**” outcome message is shown at display

LOOP		15/10 – 18:04		■
TN		▶◀		
$I_{psc}^{max}$	=	7236	A	
ZL-L	=	0.07	$\Omega$	
FREQ. = 50.00Hz				
VL-PE=223V		VL-L=387V		
<b>NOT OK</b>				
L-L	Br.Cap	6.0kA		

FUNC	MODE	Lim	
------	------	-----	--

9. Press the **SAVE** key to store the test result in the instrument's memory (see § 7.1) or the **ESC/MENU** key to exit the screen without saving and go back to the main measuring screen

### 6.7.5. TripT - Verify of protection coordination

1. Press the **MENU** key, move the cursor to **LOOP** in the main menu by means of the arrow keys (**▲**, **▼**) and confirm with **ENTER**. Subsequently the instrument displays a screen similar to the one reported here to the side.

Select the "Europe" country (see § 5.1.2), the options "TN, TN or IT", "25 or 50V", "50Hz or 60Hz" and the reference voltage in the general settings of the instrument (see § 5.1.3).

**NOTE: for countries different from "Europe" the MCB and Fuse reference type can be changed**

LOOP	15/10 – 18:04		
TN			
$I_{psc}^{min}$	=	---	A
ZL-L	=	---	$\Omega$
FREQ.	=	0.00Hz	
VL-PE=0V		VL-L=0V	
L-L	TripT	16A	0.2s
FUNC	MODE	MCB-C	Time

2. Use the **◀**, **▶** keys to select the parameter to be modified, and the **▲**, **▼** keys to modify the parameter value
- **FUNC** → the virtual key allows setting the measuring mode of the instrument, which may be: **L-N**, **L-L** or **L-PE**
  - **MODE** → the virtual key allows setting the instrument's operating mode. Select the **TripT** option
  - **Type of protection** → the virtual key allows to set type of protection (**Fuse** of type **gG**, **aM** or magnetothermal **MCB** in curve **B**, **C**, **D**, **K**) and the respective nominal currents considering the below available values:
    - MCB curve B** → 3A, 6A, 10A, 13A, 15A, 16A, 20A, 25A, 32A, 40A, 45A, 50A, 63A, 80A, 100A, 125A, 160A, 200A
    - MCB curve C** → 0.5A, 1A, 1.6A, 2A, 3A, 4A, 6A, 10A, 13A, 15A, 16A, 20A, 25A, 32A, 40A, 50A, 63A, 80A, 100A, 125A, 160A, 200A
    - MCB curve D, K** → 0.5A, 1A, 1.6A, 2A, 3A, 4A, 6A, 10A, 13A, 15A, 16A, 20A, 25A, 32A, 40A, 45A, 50A, 63A, 80A, 100A, 125A, 160A, 200A
    - Fuse gG** → 2A, 4A, 6A, 8A, 10A, 12A, 13A, 16A, 20A, 25A, 32A, 35A, 40A, 50A, 63A, 80A, 100A, 125A, 160A, 200A, 250A, 315A, 400A, 500A, 630A, 800A, 1000A, 1250A
    - Fuse aM** → 2A, 4A, 6A, 10A, 12A, 16A, 20A, 25A, 32A, 35A, 40A, 50A, 63A, 80A, 100A, 125A, 160A, 200A, 250A, 315A, 400A, 500A, 630A

press **SAVE** key to save the selected parameter and retire to the measurement screen

- **Time** → the virtual key allows to set type of protection tripping time among the options: **0.1s, 0.2s, 0.4s, 1s, 5s**

3. If possible, disconnect all loads connected downstream of the measured point, as the impedance of these users could distort the test results. Perform the preliminary calibration of the test leads as described in § 6.7.2
4. Insert the green, blue and black connectors of the three-pin shuko cable into the corresponding input leads B3, B4 and B1 of the instrument. As an alternative, use the single cables and apply the relevant alligator clips to the free ends of the cables. It is also possible to use the remote lead by inserting its multipolar connector into the input lead B1. Connect the Mains Plug, the alligator clips or the remote lead to the electrical mains according to Fig. 22, Fig. 23, Fig. 24, Fig. 25 or Fig. 26

5. Note the presence of the correct voltage values between L-L and L-PE corresponding to the selections carried out in the initial phase (see § 5.1.3) as shown in the screen to the side

LOOP		15/10 – 18:04		■
TN <span style="float: right;">▶◀</span>				
$I_{psc}^{min}$	=	---	A	
ZL-L	=	---	Ω	
FREQ. = 50.00Hz				
VL-PE=223V		VL-L=387V		
L-L	TripT	16A	0.2s	
<b>FUNC</b>	<b>MODE</b>	<b>MCB-C</b>	<b>Time</b>	

6. Press the **GO/STOP** key on the instrument, the **START** key on remote lead or the AutoStart feature (see § 5.1.5). The instrument will start the measurement and the “**Measuring...**” message is shown at display. During this whole stage, do not disconnect the measuring leads of the instrument from the system under test. The following screen appears on the instrument's display

LOOP		15/10 – 18:04		■
TN <span style="float: right;">▶◀</span>				
$I_{psc}^{min}$	=	---	A	
ZL-L	=	---	Ω	
FREQ. = 50.00Hz				
VL-PE=223V		VL-L=387V		
<b>Measuring...</b>				
L-L	TripT	16A	0.2s	
<b>FUNC</b>	<b>MODE</b>	<b>MCB-C</b>	<b>Time</b>	

7. In case of **positive** result (minimum short-circuit current interrupted by the protection device within the time indicated by the performed selections), the “**OK**” message and the screen to the side is displayed by the instrument

LOOP		15/10 – 18:04		■
TN <span style="float: right;">▶◀</span>				
$I_{psc}^{min}$	=	212	A	
ZL-L	=	1.03	Ω	
FREQ. = 50.00Hz				
VL-PE=223V		VL-L=387V		
<b>OK</b>				
L-L	TripT	16A	0.2s	

8. In case of **negative** result (minimum short-circuit current NOT interrupted by the protection device within the time indicated by the performed selections), the “**NOT OK**” message and the screen to the side is displayed by the instrument

FUNC	MODE	MCB-C	Time
LOOP 15/10 – 18:04			
TN			
$I_{psc}^{min}$	=	1681	A
ZL-L	=	0.13	$\Omega$
FREQ. = 50.00Hz			
VL-PE=223V		VL-L=387V	
<b>NOT OK</b>			
L-L	TripT	16A	0.2s
FUNC	MODE	MCB-C	Time

9. Press the **SAVE** key to store the test result in the instrument’s memory (see § 7.1) or the **ESC/MENU** key to exit the screen without saving and go back to the main measuring screen

#### 6.7.6. $R_{a\ddagger}$ 2-wire test - Verify of protection against indirect contacts

1. Press the **MENU** key, move the cursor to **LOOP** in the main menu by means of the arrow keys ( $\blacktriangle$ ,  $\blacktriangledown$ ) and confirm with **ENTER**. Subsequently the instrument displays a screen similar to the one reported here to the side. Select the “**Europe**” country (see § 5.1.2), the options “TN”, “25 or 50V”, “50Hz or 60Hz” and the reference voltage in the general settings of the instrument (see § 5.1.3).

**NOTE: for countries different from “Europe” the MCB and Fuse reference type can be changed**

FUNC	MODE	MCB-C	Time
LOOP 15/10 – 18:04			
TN			
$I_{pfc}^{min}$	=	---	A
ZL-PE	=	---	$\Omega$
FREQ. = 0.00Hz			
VL-PE=0V			
$R_{a\ddagger}$	2Wire	16A	0.2s
FUNC	MODE	MCB-C	Time

2. Use the  $\blacktriangleleft$ ,  $\blacktriangleright$  keys to select the parameter to be modified, and the  $\blacktriangle$ ,  $\blacktriangledown$  keys to modify the parameter value
- **FUNC** → the virtual key allows setting the measuring mode of the instrument, which may be:  $R_{a\ddagger}$
  - **MODE** → the virtual key allows setting the instrument’s operating mode. Select the **2Wire** option
  - **Type of protection** → the virtual key allows to set type of protection (**Fuse** of type **gG**, **aM** or magnetothermal **MCB** in curve **B**, **C**, **D**, **K**) and the respective nominal currents considering the below available values:
    - MCB curve B** → 3A, 6A, 10A, 13A, 15A, 16A, 20A, 25A, 32A, 40A, 45A, 50A, 63A, 80A, 100A, 125A, 160A, 200A
    - MCB curve C** → 0.5A, 1A, 1.6A, 2A, 3A, 4A, 6A, 10A, 13A, 15A, 16A, 20A, 25A, 32A, 40A, 50A, 63A, 80A, 100A, 125A, 160A, 200A
    - MCB curve D, K** → 0.5A, 1A, 1.6A, 2A, 3A, 4A, 6A, 10A, 13A, 15A, 16A, 20A, 25A, 32A, 40A, 45A, 50A, 63A, 80A, 100A, 125A, 160A, 200A
    - Fuse gG** → 2A, 4A, 6A, 8A, 10A, 12A, 13A, 16A, 20A, 25A, 32A, 35A, 40A, 50A, 63A, 80A, 100A, 125A, 160A, 200A, 250A, 315A, 400A, 500A, 630A, 800A, 1000A, 1250A
    - Fuse aM** → 2A, 4A, 6A, 10A, 12A, 16A, 20A, 25A, 32A, 35A, 40A, 50A, 63A, 80A, 100A, 125A, 160A, 200A, 250A, 315A, 400A, 500A, 630A
  - **Time** → the virtual key allows to set type of protection tripping time among the options: **0.1s**, **0.2s**, **0.4s**, **1s**, **5s**

3. If possible, disconnect all loads connected downstream of the measured point, as the impedance of these users could distort the test results. Perform the preliminary calibration of the test leads as described in § 6.7.2
4. Insert the green and black connectors of the three-pin shuko cable into the corresponding input leads B3 and B1 of the instrument. As an alternative, use the single cables and apply the relevant alligator clips to the free ends of the cables. It is also possible to use the remote lead by inserting its multipolar connector into the input lead B1. Connect the Mains Plug, the alligator clips or the remote lead to the electrical mains according to Fig. 28, Fig. 29 or Fig. 30

5. Note the presence of the correct voltage values between L-PE corresponding to the selections carried out in the initial phase (see § 5.1.3) as shown in the screen to the side

LOOP	15/10 – 18:04		
TN		▶◀	
$I_{pfc}^{min}$	= ---	A	
ZL-PE	= ---	Ω	
FREQ. = 50.00Hz			
VL-PE=223V			
Ra	2Wire	16A	0.2s
<b>FUNC</b>	<b>MODE</b>	<b>MCB-C</b>	<b>Time</b>

6. Press the **GO/STOP** key on the instrument, the **START** key on remote lead or the AutoStart feature (see § 5.1.5). The instrument will start the measurement and the “**Measuring...**” message is shown at display. During this whole stage, do not disconnect the measuring leads of the instrument from the system under test. The following screen appears on the instrument's display

LOOP	15/10 – 18:04		
TN		▶◀	
$I_{pfc}^{min}$	= ---	A	
ZL-PE	= ---	Ω	
FREQ. = 50.00Hz			
VL-PE=223V			
<b>Measuring...</b>			
Ra	2Wire	16A	0.2s
<b>FUNC</b>	<b>MODE</b>	<b>MCB-C</b>	<b>Time</b>

7. In case of **positive** result ( $Z_{L-PE} \leq$  to limit impedance relative to protection device within the specified time – see § 12.10), the “**OK**” message and the screen to the side is displayed by the instrument

LOOP	15/10 – 18:04		
TN		▶◀	
$I_{pfc}^{min}$	= 1213	A	
ZL-PE	= 0.18	Ω	
FREQ. = 50.00Hz			
VL-PE=223V			
<b>OK</b>			
Ra	2Wire	16A	0.2s
<b>FUNC</b>	<b>MODE</b>	<b>MCB-C</b>	<b>Time</b>



8. In case of **negative** result ( $Z_{L-PE} >$  to limit impedance relative to protection device within the specified time – see § 12.10), the “**NOT OK**” message and the screen to the side is displayed by the instrument

LOOP	15/10 – 18:04	■	
TN		▶◀	
$I_{pfc}^{min}$	= 88	A	
ZL-PE	= 2.08	$\Omega$	
FREQ. = 50.00Hz			
VL-PE=223V			
<b>NOT OK</b>			
Ra $\ddagger$	2Wire	16A	0.2s
<b>FUNC</b>	<b>MODE</b>	<b>MCB-C</b>	<b>Time</b>

9. Press the **SAVE** key to store the test result in the instrument’s memory (see § 7.1) or the **ESC/MENU** key to exit the screen without saving and go back to the main measuring screen

### 6.7.7. Ra $\ddagger$ 3-wire test - Verify of protection against indirect contacts

1. Press the **MENU** key, move the cursor to **AUTO** in the main menu by means of the arrow keys ( $\blacktriangle$ ,  $\blacktriangledown$ ) and confirm with **ENTER**. Subsequently the instrument displays a screen similar to the one reported here to the side. Select the “**Europe**” country (see § 5.1.2), the options “TN”, “25 or 50V”, “50Hz or 60Hz” and the reference voltage in the general settings of the instrument (see § 5.1.3).

**NOTE: for countries different from “Europe” the MCB and Fuse reference type can be changed**

LOOP	15/10 – 18:04	■	
TN			
Isc=---	A	ZL-N=---	$\Omega$
Ifc=---	A	ZL-PE=---	$\Omega$
FREQ=0.00Hz			
VL-N=0V		VL-PE=0V	
Ra $\ddagger$	3Wire	16A	0.2s
<b>FUNC</b>	<b>MODE</b>	<b>MCB-C</b>	<b>Time</b>

2. Use the  $\blacktriangleleft$ ,  $\blacktriangleright$  keys to select the parameter to be modified, and the  $\blacktriangle$ ,  $\blacktriangledown$  keys to modify the parameter value
- **FUNC** → the virtual key allows setting the measuring mode of the instrument, which may be: Ra $\ddagger$
  - **MODE** → the virtual key allows setting the instrument’s operating mode. Select the **3Wire** option
  - **Type of protection** → the virtual key allows to set type of protection (**Fuse** of type **gG**, **aM** or magnetothermal **MCB** in curve **B**, **C**, **D**, **K**) and the respective nominal currents considering the below available values:
    - MCB curve B** → 3A, 6A, 10A, 13A, 15A, 16A, 20A, 25A, 32A, 40A, 45A, 50A, 63A, 80A, 100A, 125A, 160A, 200A
    - MCB curve C** → 0.5A, 1A, 1.6A, 2A, 3A, 4A, 6A, 10A, 13A, 15A, 16A, 20A, 25A, 32A, 40A, 50A, 63A, 80A, 100A, 125A, 160A, 200A
    - MCB curve D, K** → 0.5A, 1A, 1.6A, 2A, 3A, 4A, 6A, 10A, 13A, 15A, 16A, 20A, 25A, 32A, 40A, 45A, 50A, 63A, 80A, 100A, 125A, 160A, 200A
    - Fuse gG** → 2A, 4A, 6A, 8A, 10A, 12A, 13A, 16A, 20A, 25A, 32A, 35A, 40A, 50A, 63A, 80A, 100A, 125A, 160A, 200A, 250A, 315A, 400A, 500A, 630A, 800A, 1000A, 1250A
    - Fuse aM** → 2A, 4A, 6A, 10A, 12A, 16A, 20A, 25A, 32A, 35A, 40A, 50A, 63A, 80A, 100A, 125A, 160A, 200A, 250A, 315A, 400A, 500A, 630A
 press **SAVE** key to save the selected parameter and retire to the measurement screen
  - **Time** → the virtual key allows to set type of protection tripping time among the

options: **0.1s, 0.2s, 0.4s, 1s, 5s**

3. If possible, disconnect all loads connected downstream of the measured point, as the impedance of these users could distort the test results. Perform the preliminary calibration of the test leads as described in § 6.7.2
4. Insert the green, blue and black connectors of the three-pin shuko cable into the corresponding input leads B3, B4 and B1 of the instrument. As an alternative, use the single cables and apply the relevant alligator clips to the free ends of the cables. It is also possible to use the remote lead by inserting its multipolar connector into the input lead B1. Connect the Mains Plug, the alligator clips or the remote lead to the electrical mains according to Fig. 22, Fig. 23, Fig. 24, Fig. 25 or Fig. 26

5. Note the correct voltage values between L-N and L-PE as shown in the screen to the side

AUTO	15/10 – 18:04	■	
TN			
Isc=---	A	ZL-N=---	Ω
Ifc=---	A	ZL-PE=---	Ω
FREQ=50.00Hz			
VL-N=232V		VL-PE=231V	
Ra $\ddagger$	3Wire	16A	0.2s
<b>FUNC</b>	<b>MODE</b>	<b>MCB-C</b>	<b>Time</b>

6. Press the **GO/STOP** key on the instrument, the **START** key on remote lead or the AutoStart feature (see § 5.1.5). The instrument will start the measurement and the “**Measuring...**” message is shown at display. During this whole stage, do not disconnect the measuring leads of the instrument from the system under test. The following screen appears on the instrument's display

AUTO	15/10 – 18:04	■	
TN			
Isc=---	A	ZL-N=---	Ω
Ifc=---	A	ZL-PE=---	Ω
FREQ=50.00Hz			
VL-N=232V		VL-PE=231V	
<b>Measuring...</b>			
Ra $\ddagger$	3Wire	16A	0.2s
<b>FUNC</b>	<b>MODE</b>	<b>MCB-C</b>	<b>Time</b>

7. In case of **positive** result ( $Z_{L-PE} \leq$  to limit impedance relative to protection device within the specified time – see § 12.10), the “**OK**” message and the screen to the side is displayed by the instrument

AUTO	15/10 – 18:04	■	
TN			
Isc=1365	A	ZL-N=0.16	Ω
Ifc=1213	A	ZL-PE=0.18	Ω
FREQ=50.00Hz			
VL-N=232V		VL-PE=231V	
<b>OK</b>			
Ra $\ddagger$	3Wire	16A	0.2s
<b>FUNC</b>	<b>MODE</b>	<b>MCB-C</b>	<b>Time</b>

8. In case of **negative** result ( $Z_{L-PE} >$  to limit impedance

AUTO	15/10 – 18:04	■	
------	---------------	---	--

relative to protection device within the specified time – see § 12.10), the “NOT OK” message and the screen to the side is displayed by the instrument

TN			
I <sub>sc</sub> =89 A ZL-N=2.06Ω			
I <sub>fc</sub> =88A ZL-PE=2.08Ω			
FREQ.=50.00Hz			
VL-N=232V VL-PE=231V			
<b>NOT OK</b>			
Ra <sub>±</sub>	3Wire	16A	0.2s
<b>FUNC</b>	<b>MODE</b>	<b>MCB-C</b>	<b>Time</b>

- Press the **SAVE** key to store the test result in the instrument’s memory (see § 7.1) or the **ESC/MENU** key to exit the screen without saving and go back to the main measuring screen

### 6.7.8. Verify of protection against indirect contacts (IT systems)

- Press the **MENU** key, move the cursor to **LOOP** in the main menu by means of the arrow keys (▲,▼) and confirm with **ENTER**. Subsequently the instrument displays a screen similar to the one reported here to the side.

Select the “**Europe**” country (see § 5.1.2), the options “IT”, “25 or 50V”, “50Hz or 60Hz” and the reference voltage in the general settings of the instrument (see § 5.1.3).

LOOP	15/10 – 18:04	■	
IT			
I <sub>pf</sub>	=	---	mA
U <sub>t</sub>	=	---	V
FREQ. = 0.00Hz			
VL-PE=0V		VL-N=0V	
L-PE	U <sub>t</sub>		
<b>FUNC</b>	<b>MODE</b>		

- Use the ◀, ▶ keys to select the parameter to be modified, and the ▲, ▼ keys to modify the parameter value:
  - **FUNC** → the virtual key allows setting the measuring mode of the instrument, which may be **L-PE**
  - **MODE** → fixed U<sub>t</sub> limit set by the user (see § 5.1.2)
- If possible, disconnect all loads connected downstream of the measured point, as the impedance of these users could distort the test results. Perform the preliminary calibration of the test leads as described in § 6.7.2
- Insert the green, blue and black connectors of the three-pin shuko cable into the corresponding input leads B3, B4 and B1 of the instrument. As an alternative, use the single cables and apply the relevant alligator clips to the free ends of the cables. It is also possible to use the remote lead by inserting its multipolar connector into the input lead B1. Connect the Mains Plug, the alligator clips or the remote lead to the electrical mains according to Fig. 27
- Note the correct voltage values between L-N and L-PE as shown in the screen to the side

LOOP	15/10 – 18:04	■	
IT			
I <sub>pf</sub>	=	---	mA
U <sub>t</sub>	=	---	V
FREQ. = 50.00Hz			
VL-PE=232V		VL-N=234V	

6. Press the **GO/STOP** key on the instrument, the **START** key on remote lead or the AutoStart feature (see § 5.1.5). The instrument will start the measurement and the “**Measuring...**” message is shown at display. During this whole stage, do not disconnect the measuring leads of the instrument from the system under test. The following screen appears on the instrument's display

L-PE	Ut		
<b>FUNC</b>	<b>MODE</b>		
LOOP 15/10 – 18:04 <span style="float: right;">■</span>			
IT			
Ipfc	=	---	mA
Ut	=	---	V
FREQ. = 50.00Hz			
VL-PE=232V		VL-N=234V	
<b>Measuring...</b>			
L-PE	Ut		
<b>FUNC</b>	<b>MODE</b>		

7. In case of **positive** result (contact voltage at the point <50V or <25V), the “**OK**” message and the screen to the side is displayed by the instrument which contains the value of the first fault current measured, expressed in **mA** (see §)

L-PE	Ut		
<b>FUNC</b>	<b>MODE</b>		
LOOP 15/10 – 18:04 <span style="float: right;">■</span>			
IT			
Ipfc	=	83	mA
Ut	=	1	V
FREQ. = 50.00Hz			
VL-PE=232V		VL-N=234V	
<b>OK</b>			
L-PE	Ut		
<b>FUNC</b>	<b>MODE</b>		

8. In case of **negative** result (contact voltage at the point >50V or >25V) the “**NOT OK**” message and the screen to the side is displayed by the instrument the screen to the side

L-PE	Ut		
<b>FUNC</b>	<b>MODE</b>		
LOOP 15/10 – 18:04 <span style="float: right;">■</span>			
IT			
Ipfc	=	>999	mA
Ut	=	>50	V
FREQ. = 50.00Hz			
VL-PE=232V		VL-N=234V	
<b>NOT OK</b>			
L-PE	Ut		
<b>FUNC</b>	<b>MODE</b>		

9. Press the **SAVE** key to store the test result in the instrument's memory (see § 7.1) or the **ESC/MENU** key to exit the screen without saving and go back to the main measuring screen

### 6.7.9. Verify of protection against indirect contacts (TT systems)

1. Press the **MENU** key, move the cursor to **LOOP** in the main menu by means of the arrow keys (**▲**, **▼**) and confirm with **ENTER**. Subsequently the instrument displays a screen similar to the one reported here to the side.

Select the “**Europe**” country (see § 5.1.2), the options “TT”, “25 or 50V”, “50Hz or 60Hz” and the reference voltage in the general settings of the instrument (see § 5.1.3).

LOOP		15/10 – 18:04		
TT				
R <sub>A</sub>	=	---	Ω	
U <sub>t</sub>	=	---	V	
FREQ. = 0.00Hz				
VL-PE=0V				
R <sub>a</sub> ⚡	2Wire	30mA		
<b>FUNC</b>	MODE	IΔn		

2. Use the **◀**, **▶** keys to select the parameter to be modified, and the **▲**, **▼** keys to modify the parameter value:
  - **FUNC** → the virtual key allows setting the measuring mode of the instrument, which may be **R<sub>a</sub>⚡**
  - **MODE** → fixed **2-Wire** mode
  - **IΔn** → The virtual key allows setting the nominal value of the RCD's tripping current, which may be: **6mA, 10mA, 30mA, 100mA, 300mA, 500mA, 650mA, 1000mA**  
press **SAVE** key to save the selected parameter and retire to the measurement screen
3. If possible, disconnect all loads connected downstream of the measured point, as the impedance of these users could distort the test results. Perform the preliminary calibration of the test leads as described in § 6.7.2
4. Insert the green and black connectors of the three-pin shuko cable into the corresponding input leads B3 and B1 of the instrument. As an alternative, use the single cables and apply the relevant alligator clips to the free ends of the cables. It is also possible to use the remote lead by inserting its multipolar connector into the input lead B1. Connect the Mains Plug, the alligator clips or the remote lead to the electrical mains according to Fig. 28, Fig. 29 or Fig. 30
5. Note the correct voltage values between L-PE as shown 

LOOP	15/10 – 18:04	
------	---------------	---

in the screen to the side

TT			
RA	=	---	Ω
Ut	=	---	V
FREQ. = 50.00Hz			
VL-PE=232V			
Ra $\nabla$	2Wire	30mA	
<b>FUNC</b>	<b>MODE</b>	IΔn	

6. Press the **GO/STOP** key on the instrument, the **START** key on remote lead or the AutoStart feature (see § 5.1.5). The instrument will start the measurement and the “**Measuring...**” message is shown at display. During this whole stage, do not disconnect the measuring leads of the instrument from the system under test. The following screen appears on the instrument's display

LOOP 15/10 – 18:04			
TT			
RA	=	---	Ω
Ut	=	---	V
FREQ. = 50.00Hz			
VL-PE=232V			
<b>Measuring...</b>			
Ra $\nabla$	2Wire	30mA	
<b>FUNC</b>	<b>MODE</b>	IΔn	

7. In case of **positive** result (**overall earth resistance  $R_A < (U_{lim}/I_{\Delta n})$** ), the “**OK**” message and the screen to the side is displayed by the instrument which contains the contact voltage value in the secondary display

LOOP 15/10 – 18:04			
TT			
RA	=	346	Ω
Ut	=	10.4	V
FREQ. = 50.00Hz			
VL-PE=232V			
<b>OK</b>			
Ra $\nabla$	2Wire	30mA	
<b>FUNC</b>	<b>MODE</b>	IΔn	

8. In case of **negative** result (**overall earth resistance  $R_A > (U_{lim}/I_{\Delta n})$** ), the “**NOT OK**” message and the screen to the side is displayed by the instrument which contains the contact voltage value in the secondary display

LOOP 15/10 – 18:04			
TT			
RA	=	1765	Ω
Ut	=	>50	V
FREQ. = 50.00Hz			
VL-PE=232V			
<b>NOT OK</b>			
Ra $\nabla$	2Wire	30mA	
<b>FUNC</b>	<b>MODE</b>	IΔn	

9. Press the **SAVE** key to store the test result in the instrument's memory (see § 7.1) or the **ESC/MENU** key to exit the screen without saving and go back to the main measuring screen

#### 6.7.10. Verify of protection against indirect contacts (TN systems)

9. Press the **MENU** key, move the cursor to **LOOP** in the main menu by means of the arrow keys (**▲**, **▼**) and confirm with **ENTER**. Subsequently the instrument displays a screen similar to the one reported here to the side. Select the "Europe" country (see § 5.1.2), the options "TN", "25 or 50V", "50Hz or 60Hz" and the reference voltage in the general settings of the instrument (see § 5.1.3).

**NOTE: for countries different from "Europe" the MCB and Fuse reference type can be changed**

LOOP	15/10 – 18:04	■	
TN			
$I_{pfc}^{\min}$	=	---	A
ZL-PE	=	---	$\Omega$
FREQ. = 0.00Hz			
VL-PE=0V		VL-N=0V	
L-PE	Ut	16A	0.2s
<b>FUNC</b>	<b>MODE</b>	<b>MCB-C</b>	<b>Time</b>

10. Use the **◀**, **▶** keys to select the parameter to be modified, and the **▲**, **▼** keys to modify the parameter value
- **FUNC** → the virtual key allows setting the measuring mode of the instrument, which may be **L-PE**
  - **MODE** → the virtual key allows setting the instrument's operating mode. Select the **Ut** option
  - **Type of protection** → the virtual key allows to set type of protection (**Fuse** of type **gG**, **aM** or magnetothermal **MCB** in curve **B**, **C**, **D**, **K**) and the respective nominal currents considering the below available values:
    - MCB curve B** → 3A, 6A, 10A, 13A, 15A, 16A, 20A, 25A, 32A, 40A, 45A, 50A, 63A, 80A, 100A, 125A, 160A, 200A
    - MCB curve C** → 0.5A, 1A, 1.6A, 2A, 3A, 4A, 6A, 10A, 13A, 15A, 16A, 20A, 25A, 32A, 40A, 50A, 63A, 80A, 100A, 125A, 160A, 200A
    - MCB curve D, K** → 0.5A, 1A, 1.6A, 2A, 3A, 4A, 6A, 10A, 13A, 15A, 16A, 20A, 25A, 32A, 40A, 45A, 50A, 63A, 80A, 100A, 125A, 160A, 200A
    - Fuse gG** → 2A, 4A, 6A, 8A, 10A, 12A, 13A, 16A, 20A, 25A, 32A, 35A, 40A, 50A, 63A, 80A, 100A, 125A, 160A, 200A, 250A, 315A, 400A, 500A, 630A, 800A, 1000A, 1250A
    - Fuse aM** → 2A, 4A, 6A, 10A, 12A, 16A, 20A, 25A, 32A, 35A, 40A, 50A, 63A, 80A, 100A, 125A, 160A, 200A, 250A, 315A, 400A, 500A, 630A
 press **SAVE** key to save the selected parameter and retire to the measurement screen

- **Time** → the virtual key allows to set type of protection tripping time among the options: **0.1s, 0.2s, 0.4s, 1s, 5s**

11. If possible, disconnect all loads connected downstream of the measured point, as the impedance of these users could distort the test results. Perform the preliminary calibration of the test leads as described in § 6.7.2
12. Insert the green, blue and black connectors of the three-pin shuko cable into the corresponding input leads B3, B4 and B1 of the instrument. As an alternative, use the single cables and apply the relevant alligator clips to the free ends of the cables. It is also possible to use the remote lead by inserting its multipolar connector into the input lead B1. Connect the Mains Plug, the alligator clips or the remote lead to the electrical mains according to Fig. 22, Fig. 23, Fig. 24, Fig. 25 or Fig. 26

13. Note the presence of the correct voltage values between L-N and L-PE corresponding to the selections carried out in the initial phase (see § 5.1.3) as shown in the screen to the side

LOOP		15/10 – 18:04		
TN <span style="float: right;">▶◀</span>				
$I_{pfc}^{min}$	=	---	A	
ZL-PE	=	---	Ω	
FREQ. = 50.00Hz				
VL-PE=232V		VL-N=231V		
L-PE	Ut	16A	0.2s	
<b>FUNC</b>	<b>MODE</b>	<b>MCB-C</b>	<b>Time</b>	

14. Press the **GO/STOP** key on the instrument, the **START** key on remote lead or the AutoStart feature (see § 5.1.5). The instrument will start the measurement and the “**Measuring...**” message is shown at display. During this whole stage, do not disconnect the measuring leads of the instrument from the system under test. The following screen appears on the instrument's display

LOOP		15/10 – 18:04		
TN <span style="float: right;">▶◀</span>				
$I_{pfc}^{min}$	=	---	A	
ZL-PE	=	---	Ω	
FREQ. = 50.00Hz				
VL-PE=232V		VL-N=231V		
<b>Measuring...</b>				
L-PE	Ut	16A	0.2s	
<b>FUNC</b>	<b>MODE</b>	<b>MCB-C</b>	<b>Time</b>	

15. In case of **positive** result (calculated minimum short-circuit current **HIGHER** than tripping current of the protection device within the specified time – see § 12.6), the “**OK**” message and the screen to the side is displayed by the instrument

LOOP		15/10 – 18:04		
TN <span style="float: right;">▶◀</span>				
$I_{pfc}^{min}$	=	214	A	
ZL-PE	=	1.03	Ω	
FREQ. = 50.00Hz				
VL-PE=232V		VL-N=231V		
<b>OK</b>				
L-PE	Ut	16A	0.2s	
<b>FUNC</b>	<b>MODE</b>	<b>MCB-C</b>	<b>Time</b>	



16. In case of **negative** result (calculated minimum short-circuit current LOWER than tripping current of the protection device within the specified time – see § 12.6), the “**NOT OK**” message and the screen to the side is displayed by the instrument

LOOP	15/10 – 18:04	■	
TN	▶◀◀		
$I_{pfc}^{min}$	=	1695	A
ZL-PE	=	0.13	$\Omega$
FREQ. = 50.00Hz			
VL-PE=232V		VL-N=231V	
<b>NOT OK</b>			
L-PE	Ut	16A	0.2s
<b>FUNC</b>	<b>MODE</b>	MCB-C	Time

17. Press the **SAVE** key to store the test result in the instrument’s memory (see § 7.1) or the **ESC/MENU** key to exit the screen without saving and go back to the main measuring screen

### 6.7.11. Anomalous situations

1. If the instrument detects a frequency higher than the maximum limit (63Hz), it does not carry out the test and displays a screen like the one to the side

LOOP	15/10 – 18:04	■	
TN			
Ipfc	=	---	A
ZL-PE	=	---	$\Omega$
FREQ. = >63Hz			
VL-PE=0V		VL-N=0V	
<b>Freq. out of range</b>			
L-PE	STD		
<b>FUNC</b>	<b>MODE</b>		

2. If the instrument detects an L-N or L-PE voltage lower than the minimum limit (100V), it does not carry out the test and displays a screen like the one to the side. Check that the system being tested is supplied

LOOP	15/10 – 18:04	■	
TN			
Ipfc	=	---	A
ZL-PE	=	---	$\Omega$
FREQ. = 50.00Hz			
VL-PE <100V		VL-N <100V	
<b>Voltage &lt;100V</b>			
L-PE	STD		
<b>FUNC</b>	<b>MODE</b>		

3. If the instrument detects an L-N or L-PE voltage higher than the maximum limit (265V), it does not carry out the test and displays a screen like the one to the side. Check the connection of measuring cables

LOOP	15/10 – 18:04	■	
TN			
Ipfc	=	---	A
ZL-PE	=	---	$\Omega$
FREQ. = 50.00Hz			
VL-PE >265V		VL-N >265V	
<b>Voltage &gt;265V</b>			
L-PE	STD		
<b>FUNC</b>	<b>MODE</b>		

4. If the instrument detects an L-L voltage higher than the maximum limit (460V), it does not carry out the test and displays a screen like the one to the side. Check the connection of measuring cables

LOOP 15/10 – 18:04			
TN			
Ipfc	=	---	A
ZL-L	=	---	$\Omega$
FREQ. = 50.00Hz			
VL-PE=>265V VL-L=>460V			
<b>Voltage &gt;460V</b>			
L-L	STD		
<b>FUNC</b>	<b>MODE</b>		

5. If the instrument detects a dangerous voltage on PE conductor it provides the warning screen shown to the side and blocks the execution of the tests. Check the PE conductor and earth plant efficiency

LOOP 15/10 – 18:04			
TN			
Ipfc	=	---	A
ZL-PE	=	---	$\Omega$
FREQ. = 50.00Hz			
VL-PE= 231V VL-N= 234V			
<b>Voltage on PE</b>			
L-PE	STD		
<b>FUNC</b>	<b>MODE</b>		

6. If the instrument detects the absence of the signal to terminal B4 (neutral conductor), it provides the warning screen shown to the side and blocks the execution of the tests

LOOP 15/10 – 18:04			
TN			
Ipfc	=	---	A
ZL-PE	=	---	$\Omega$
FREQ. = 50.00Hz			
VL-PE= 231V VL-N= 115V			
<b>Missing N</b>			
L-PE	STD		
<b>FUNC</b>	<b>MODE</b>		

7. If the instrument detects the absence of the signal to terminal B3 (PE conductor), it provides the warning screen shown to the side and blocks the execution of the tests

LOOP 15/10 – 18:04			
TN			
Ipfc	=	---	A
ZL-PE	=	---	$\Omega$
FREQ. = 50.00Hz			
VL-PE= 115V VL-N= 231V			
<b>Missing PE</b>			
L-PE	STD		
<b>FUNC</b>	<b>MODE</b>		

8. If the instrument detects the absence of the signal to terminal B1 (phase conductor), it provides the warning screen shown to the side and blocks the execution of the tests

LOOP	15/10 – 18:04		
TN			
Ipfc	=	---	A
ZL-PE	=	---	$\Omega$
FREQ. = 50.00Hz			
VL-PE= 0V		VL-N= 0V	
<b>Missing L</b>			
L-PE	STD		
<b>FUNC</b>	<b>MODE</b>		

9. If the instrument detects that the phase L and neutral N leads are inverted, it does not carry out the test and a screen similar to the one reported to the side is displayed. Rotate the Mains Plug or check the connection of measuring cables

LOOP	15/10 – 18:04		
TN			
Ipfc	=	---	A
ZL-PE	=	---	$\Omega$
FREQ. = 50.00Hz			
VL-PE= 1V		VL-N= 231V	
<b>Echange L-N</b>			
L-PE	STD		
<b>FUNC</b>	<b>MODE</b>		

10. If the instrument detects that the phase and PE leads are inverted, it does not carry out the test and a screen similar to the one reported to the side is displayed. Check the connection of measuring cables

LOOP	15/10 – 18:04		
TN			
Ipfc	=	---	A
ZL-PE	=	---	$\Omega$
FREQ. = 50.00Hz			
VL-PE= 231V		VL-N= 1V	
<b>Echange L-PE</b>			
L-PE	STD		
<b>FUNC</b>	<b>MODE</b>		

11. If the instrument detects a dangerous contact voltage  $U_t$  (over the set limit 25V or 50V) in the starting pre-test, it provides the warning screen shown to the side and blocks the execution of the tests. Check the PE conductor and earth plant efficiency

LOOP	15/10 – 18:04		
TT			
RA	=	---	$\Omega$
$U_t$	=	---	V
FREQ. = 50.00Hz			
VL-PE= 231V			
<b>Contact Volt. &gt; Lim</b>			
Ra	2Wire	30mA	
<b>FUNC</b>	<b>MODE</b>	$I_{\Delta n}$	

### 6.8. LOZ: LINE/LOOP IMPEDANCE WITH HIGH RESOLUTION

This Line/loop impedance measurements with high resolution (0.1mΩ) is performed by using the optional accessory **IMP57** connected to the Master unit through the optical cable/RS-232 C2001 supplied with same accessory. The IMP57 must be directly powered by the mains on which measurements are performed. For detailed information, please refer to the user manual of the accessory IMP57.

Please find below the procedure for the measurement of **STD L-L impedance in TN systems**. The same procedures can be applied to any other case considering what is reported in previous § 6.7.

1. Press the **MENU** key, move the cursor to **LoZ** in the main menu by means of the arrow keys (**▲**,**▼**) and confirm with **ENTER**. Subsequently the instrument displays a screen similar to the one reported here to the side. The "**IMP57 not detected**" message indicates that the IMP57 accessory is not connected to the instrument or not powered directly by the mains

LoZ	15/10 – 18:04	■
TN		
Ipsc =	---	A
ZL-L =	---	mΩ
R =	---	mΩ
X =	---	mΩ
FREQ. =	---	Hz
VL-L =	---	V
IMP57 not detected		
L-L	STD	
FUNC	MODE	

2. Connect the IMP57 to the instrument via the cable C2001 and to the powered system via the input terminals **C1**, **C2** and **P1**, **P2** placed on it (see the IMP57 user manual). The following screen appears on the display

LoZ	15/10 – 18:04	■
TN		
Ipsc =	---	A
ZL-L =	---	mΩ
R =	---	mΩ
X =	---	mΩ
FREQ. =	50.0	Hz
VL-L =	384	V
L-L	STD	
FUNC	MODE	

3. Press the **GO/STOP** key for few seconds on the instrument to start the test. The following screen is shown on the display (in case of L-L measurement in STD mode).

LoZ	15/10 – 18:04	■
TN		
Ipsc =	15.3	kA
ZL-L =	15.0	mΩ

The standard (STD) prospective short-circuit current is shown on the display. The L-L Loop impedance values, in addition to its resistive and reactive components, are shown in the central part of the display, expressed in  $m\Omega$

R = 13.2 $m\Omega$		X = 7.5 $m\Omega$	
FREQ. = 50.0Hz			
VL-L= 384V			
L-L	STD		
<b>FUNC</b>	MODE		

- Press the **SAVE** key to store the test result in the instrument's memory (see § 7.1) or the **ESC/MENU** key to exit the screen without saving and go back to the main measuring screen

### 6.9. 1,2,3: PHASE SEQUENCE AND PHASE CONCORDANCE TEST

This function is performed in compliance with standards IEC/EN61557-7 and allows testing the phase sequence and concordance **with 1-wire method** by direct contact with live parts (not on cables with insulating sheath).

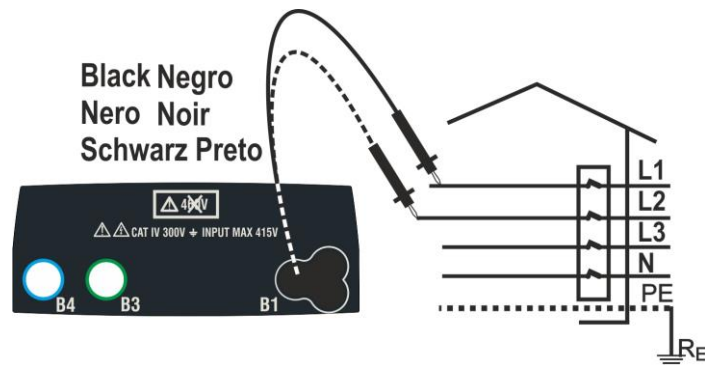

Fig. 31: Phase sequence check with terminal lead

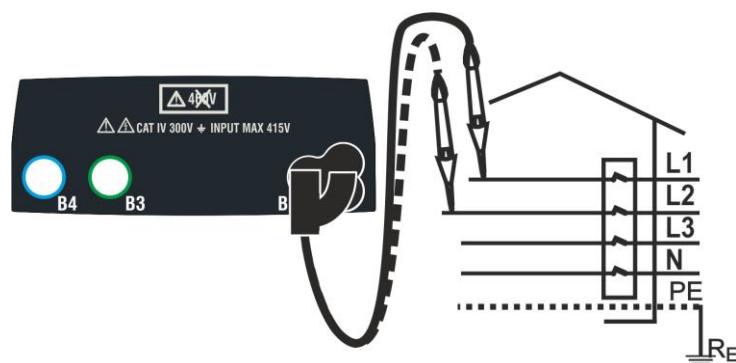

Fig. 32: Phase sequence check with remote lead

- Press the **MENU** key, move the cursor to **123** in the main menu by means of the arrow keys ( $\blacktriangle$ ,  $\blacktriangledown$ ) and confirm with **ENTER**. Subsequently the instrument displays a screen similar to the one reported here to the side

1 2 3	15/10 - 18:04	
TN		
	---	

1T			
MODE			

- Insert the black lead connector into the corresponding input lead B1 of the instrument. As an alternative, use the single cable and apply the relevant alligator clips to the free ends of the cables. It is also possible to use the remote lead by inserting its multipolar connector into the input lead B1. Connect the alligator clips or the remote lead to the electrical mains according to Fig. 31 or Fig. 32

- Press the **GO/STOP** key on the instrument or the **START** key on the remote lead. The instrument will start the test.

The "**Touch L1**" message is shown on the display to indicate the waiting for the instrument to be connected to the L1 phase of the system being tested.

Touch the live part of L1 phase

1 2 3	15/10 – 18:04	■	
TN			
- - -			
<b>Touch L1</b>			
1T			
MODE			

- The instrument gives out a long sound until input voltage is present. At the end of phase L1 acquisition, the instrument is in standby waiting for the signal on phase L2 and showing the symbol of "**Disconnect L1**" as shown in the screen to the side

1 2 3	15/10 – 18:04	■	
TN			
- - -			
<b>Disconnect L1</b>			
1T			
MODE			

- Under these conditions, connect the alligator clips, the tips or the remote lead to phase L2 in accordance to Fig. 31 or Fig. 32.

The "**Touch L2**" message is shown on the display to indicate the waiting for the instrument to be connected to the L2 phase of the system being tested.

Touch the live part of L2 phase

1 2 3	15/10 – 18:04	■	
TN			
- - -			
<b>Touch L2</b>			
1T			
MODE			

- The instrument gives out a long sound until input voltage

1 2 3	15/10 – 18:04	■	
-------	---------------	---	--

is present. At the end of the test, if the detected phase sequence is correct, the instrument displays a screen like the one shown to the side (result "123") and the "OK" message.

TN			
1 2 3			
OK			
1T			
MODE			

7. At the end of the test, if the detected phase sequence is incorrect, the instrument displays a screen like the one shown to the side (result "213") and the "NOT OK" message

1 2 3	15/10 - 18:04	■	
TN			
2 1 3			
NOT OK			
1T			
MODE			

8. At the end of the test, if the two detected voltages are in phase (phase concordance between two distinct three-phase systems), the instrument displays a screen like the one to the side (result "11-") and the "OK" message

1 2 3	15/10 - 18:04	■	
TN			
1 1 -			
OK			
1T			
MODE			

9. Press the **SAVE** key to store the test result in the instrument's memory (see § 7.1) or the **ESC/MENU** key to exit the screen without saving and go back to the main measuring screen

### 6.9.1. Anomalous situations

1. If the instrument detects an input voltage frequency exceeding the allowed full scale, it will display a screen like the one to the side

1 2 3	15/10 – 18:04	■	
TN			
- - -			
Freq. out of range			
1T			
MODE			

2. If the instrument detects an input L-PE voltage exceeding the 265V, it will display a screen like the one to the side

1 2 3	15/10 – 18:04	■	
TN			
- - -			
Voltage > 265V			
1T			
MODE			

3. If between the test start and the acquisition of the first voltage or between the acquisition of the first and second voltage, a time longer than around 10s has elapsed, the instrument displays a screen like the one to the side. It is necessary to repeat the test

1 2 3	15/10 – 18:04	■	
TN			
- - -			
Time out			
1T			
MODE			



### 6.10. $\Delta V\%$ : VOLTAGE DROP OF MAIN LINES

This feature allows to evaluating the percentage value of voltage drop between two points of a main line in which a protection device is installed and comparing this value to possible limit value specified by guidelines. The following modes are available

- **L-N** Measurement of Phase to Neutral line impedance. The test can be performed also with high resolution (0.1m $\Omega$ ) with optional accessory IMP57
- **L-L** Measurement of Phase to Phase line impedance. The test can be performed also with high resolution (0.1m $\Omega$ ) with optional accessory IMP57

#### CAUTION



The measurement of line impedance or fault loop impedance involves the circulation of a maximum current according to the technical specifications of the instrument (see § 10.1). This could cause the tripping of possible magnetothermal or differential protections at lower tripping currents

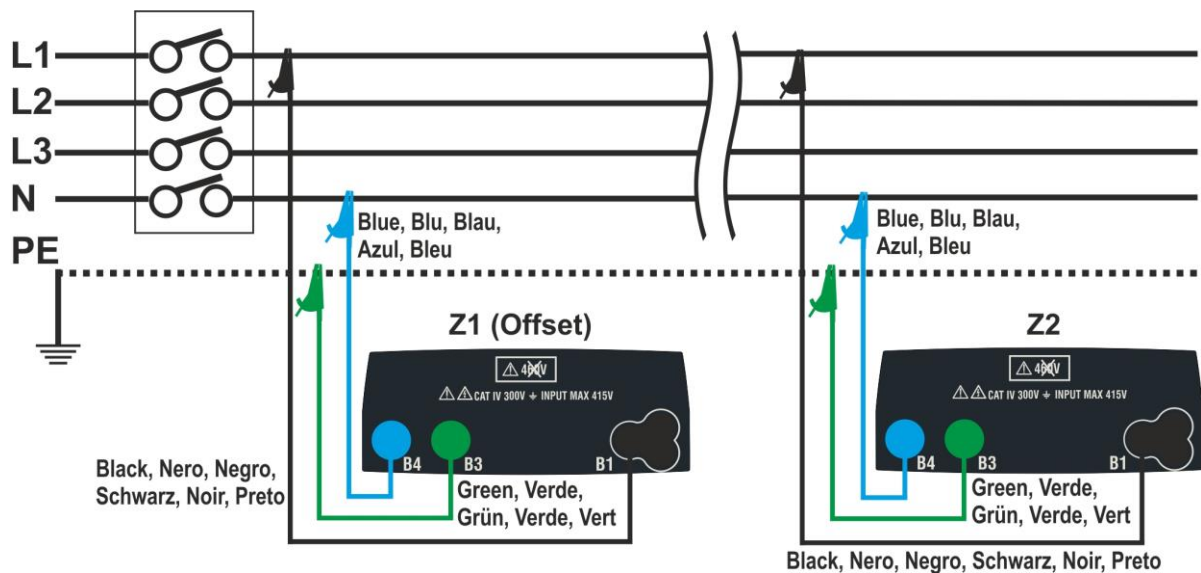

Fig. 33: Connection of the instrument for L-N mode voltage drop measurement

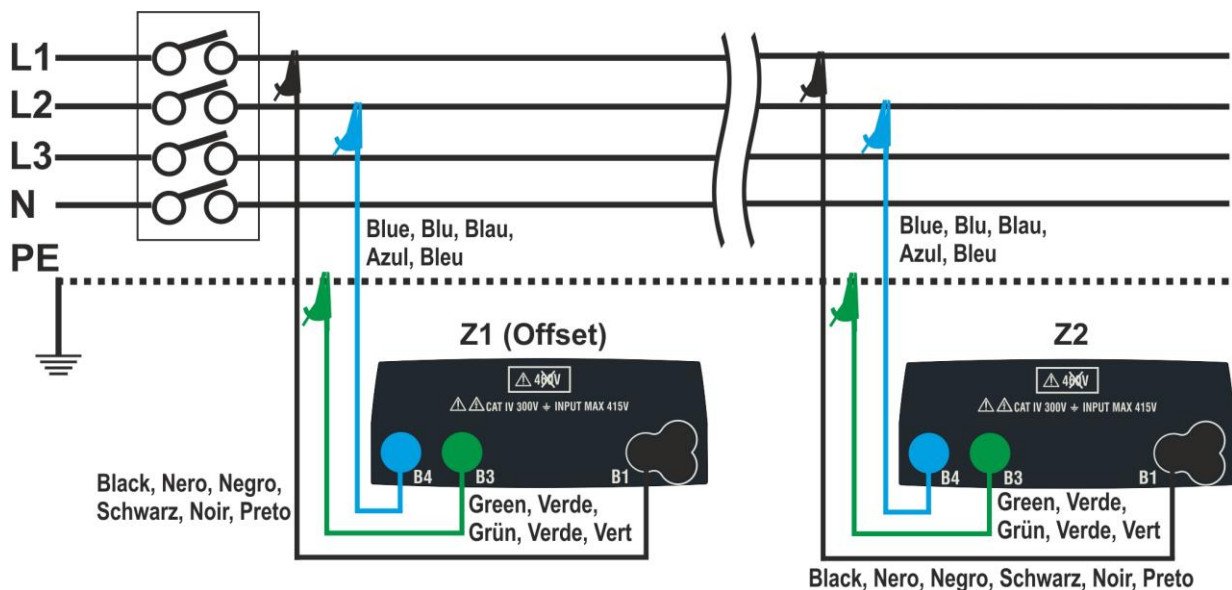

Fig. 34: Connection of the instrument for L-L mode voltage drop measurement

- Press the **MENU** key, move the cursor to  $\Delta V\%$  in the main menu by means of the arrow keys ( $\blacktriangle$ ,  $\blacktriangledown$ ) and confirm with **ENTER**. Subsequently the instrument displays a screen similar to the one reported here to the side.

$\Delta V\%$	15/10 – 18:04			
$\Delta V\%$	=	---	%	
ZL-N	=	---	$\Omega$	
FREQ. = 0.00 Hz				
VL-PE= 0 V		VL-N= 0 V		
L-N	16A	4%	0.00 $\Omega$	
<b>MODE</b>	Inom	Lim.	Z> $\phi$ <	

- Use the  $\blacktriangleleft$ ,  $\blacktriangleright$  keys to select the parameter to be modified, and the  $\blacktriangle$ ,  $\blacktriangledown$  keys to modify the parameter value:

- **MODE** → this virtual key allows setting the test mode. The following options are available: **L-N**, **L-L**, **CAL**
- **Inom** → this virtual key allows setting the value of rated current of protection device in the range **1A** to **999A** in step of **1A**
- **Lim** → this virtual key allows setting the maximum allowed limit value of voltage drop ( $\Delta V\%$ ) for the main line being tested
- **Z> $\phi$ <** → this position allows to perform the first **Z1(Offset)** impedance measurement. In this case the instrument will measure the impedance upstream zeroed of the initial point of the main line being tested taking it as start reference

- Select the **CAL** mode by means of the arrow keys  $\blacktriangle$ ,  $\blacktriangledown$  and perform the test cables or the cable with Mains Plug calibration by using the **ZEROLOOP** accessory before performing the test (see § 6.7.2)

- Connect the instrument to the initial point of the main line being tested (typically downstream to a protection device) according to Fig. 33 or Fig. 34 in order to carry out the first **Z1 (Offset)** impedance measurement. In this case the instrument will measure the impedance upstream of the initial point of the main line being tested taking it as start reference. The following screen (referred to L-L measurement) appears on the display

- Use the  $\blacktriangleleft$ ,  $\blacktriangleright$  keys and move the cursor in the “Z> $\phi$ <” position. Press the **GO/STOP** key for few seconds on the instrument to start the test. The following screen is shown on the display

$\Delta V\%$	15/10 – 18:04			
$\Delta V\%$	=	---	%	$\blacktriangleright\phi\blacktriangleleft$
ZL-L	=	---	$\Omega$	
FREQ. = 50.00 Hz				
VL-PE= 223V		VL-L= 387V		
L-L	16A	4%	0.00 $\Omega$	
<b>MODE</b>	Inom	Lim.	Z> $\phi$ <	

6. Use the ◀, ▶ keys and move the cursor in the “Z>ϕ<” position. Press the **GO/STOP** key for few seconds on the instrument to start the test. The result of the Z1(offset ) measurement is shown on the display up the “Z>ϕ<” position. If Z1(offset) value <10Ω the “OK” outcome is shown on the display and is automatically saved in the internal buffer

ΔV%	15/10 – 18:04			▶◀
ΔV%	=	---	%	▶◀
ZL-L	=	---	Ω	
FREQ. = 50.00 Hz VL-PE= 223V VL-L= 387V				
<b>OK</b>				
L-L	16A	4%	1.48Ω	
MODE	Inom	Lim.	Z>ϕ<	

7. Connect the instrument to the final point of the main line being tested according to Fig. 33 or Fig. 34 in order to measure the **Z2** impedance at the end of line. Note the previously measured Z1 (Offset) value displayed

8. Use the ◀, ▶ keys and move the cursor in any position except the “Z>ϕ<”. Press the **GO/STOP** key on the instrument to measure the Z2 impedance and complete the ΔV% voltage drop measurement. During this whole stage, do not disconnect the measuring leads of the instrument from the system being tested. In case of positive result (**maximum percentage value of calculated voltage drop according to § 12.11 < set limit value**), the “OK” outcome and the screen to the side is displayed by the instrument, which contains the value of the **Z2** end of line impedance together the **Z1 (Offset)** value

ΔV%	15/10 – 18:04			▶◀
ΔV%	=	0.4	%	▶◀
ZL-L	=	1.57	Ω	
FREQ. = 50.00 Hz VL-PE= 223V VL-L= 387V				
<b>OK</b>				
L-L	16A	4%	1.48Ω	
MODE	Inom	Lim.	Z>ϕ<	

9. In case of negative result (**maximum percentage value of calculated voltage drop according to § 12.11 > set limit value**), the “NOT OK” outcome and the screen to the side is displayed by the instrument, which contains the value of the **Z2** end of line impedance together the **Z1 (Offset)** value

ΔV%	15/10 – 18:04			▶◀
ΔV%	=	19.5	%	▶◀
ZL-L	=	5.97	Ω	
FREQ. = 50.00 Hz VL-PE= 223V VL-L= 387V				
<b>NOT OK</b>				
L-L	16A	4%	1.48Ω	
MODE	Inom	Lim.	Z>ϕ<	

10. Press the **SAVE** key to store the test result in the instrument’s memory (see § 7.1) or the **ESC/MENU** key to exit the screen without saving and go back to the main measuring screen

### 6.10.1. Anomalous situations

1. If the instrument detects a frequency higher than the maximum limit (63Hz), it does not carry out the test and displays a screen like the one to the side.

$\Delta V\%$	15/10 – 18:04	
$\Delta V\%$	= --- %	
ZL-N	= --- $\Omega$	
FREQ. >63 Hz		
VL-PE= 232V VL-N= 232V		
<b>Freq. out of range</b>		
L-N	16A 4% 0.12 $\Omega$	
MODE	Inom	Lim. Z> $\phi$ <

2. If the instrument detects an L-N or L-PE voltage lower than the minimum limit (100V), it does not carry out the test and displays a screen like the one to the side. Check that the system being tested is supplied.

$\Delta V\%$	15/10 – 18:04	
$\Delta V\%$	= --- %	
ZL-N	= --- $\Omega$	
FREQ.= 50.00 Hz		
VL-PE <100V VL-N<100V		
<b>Voltage &lt;100V</b>		
L-N	16A 4% 0.12 $\Omega$	
MODE	Inom	Lim. Z> $\phi$ <

3. If the instrument detects an L-L voltage higher than the maximum limit (460V), it does not carry out the test and displays a screen like the one to the side. Check the connection of measuring cables.

$\Delta V\%$	15/10 – 18:04	
$\Delta V\%$	= --- %	
ZL-N	= --- $\Omega$	
FREQ.= 50.00 Hz		
VL-PE= 242V VL-L >460V		
<b>Voltage &gt;460V</b>		
L-L	16A 4% 0.12 $\Omega$	
MODE	Inom	Lim. Z> $\phi$ <

4. If the instrument detects an L-N or L-PE voltage higher than the maximum limit (265V), it does not carry out the test and displays a screen like the one to the side. Check the connection of measuring cables.

$\Delta V\%$	15/10 – 18:04	
$\Delta V\%$	= --- %	
ZL-N	= --- $\Omega$	
FREQ.= 50.00 Hz		
VL-PE >265V VL-N >265V		
<b>Voltage &gt;265V</b>		
L-N	16A 4% 0.12 $\Omega$	
MODE	Inom	Lim. Z> $\phi$ <

5. If the instrument detects a dangerous voltage on PE conductor it provides the warning screen shown to the side and blocks the execution of the tests. Check the PE conductor and earth plant efficiency

$\Delta V\%$	15/10 – 18:04	
$\Delta V\%$	= --- %	
ZL-N	= --- $\Omega$	
FREQ.= 50.00Hz		
VL-PE= 232V VL-N= 232V		
<b>Voltage on PE</b>		
L-N	16A	4% 0.12 $\Omega$
<b>MODE</b>	Inom	Lim. Z> $\phi$ <

6. If the instrument detects the absence of the signal to terminal B1 (phase conductor), it provides the warning screen shown to the side and blocks the execution of the tests

$\Delta V\%$	15/10 – 18:04	
$\Delta V\%$	= --- %	
ZL-N	= --- $\Omega$	
FREQ.= 50.00Hz		
VL-PE= 0V VL-N= 0V		
<b>Missing L</b>		
L-N	16A	4% 0.12 $\Omega$
<b>MODE</b>	Inom	Lim. Z> $\phi$ <

7. If the instrument detects the absence of the signal to terminal B4 (neutral conductor), it provides the warning screen shown to the side and blocks the execution of the tests

$\Delta V\%$	15/10 – 18:04	
$\Delta V\%$	= --- %	
ZL-N	= --- $\Omega$	
FREQ.= 50.00Hz		
VL-PE= 232V VL-N= 115V		
<b>Missing N</b>		
L-N	16A	4% 0.12 $\Omega$
<b>MODE</b>	Inom	Lim. Z> $\phi$ <

8. If the instrument detects the absence of the signal to terminal B3 (PE conductor), it provides the warning screen shown to the side and blocks the execution of the tests

$\Delta V\%$	15/10 – 18:04	
$\Delta V\%$	= --- %	
ZL-N	= --- $\Omega$	
FREQ.= 50.00Hz		
VL-PE= 115V VL-N= 232V		
<b>Missing PE</b>		
L-N	16A	4% 0.12 $\Omega$
<b>MODE</b>	Inom	Lim. Z> $\phi$ <

9. If the instrument detects that the phase L and neutral N leads are inverted, it does not carry out the test and a screen similar to the one reported to the side is displayed. Rotate the Mains Plug or check the connection of measuring cables

$\Delta V\%$	15/10 – 18:04	
$\Delta V\%$	= --- %	
ZL-N	= --- $\Omega$	
FREQ.= 50.00Hz		
VL-PE= 1V VL-N= 232V		
<b>Exchange L-N</b>		
L-N	16A 4% 0.12 $\Omega$	
<b>MODE</b>	Inom	Lim. Z> $\phi$ <

10. If the instrument detects that the phase and PE leads are inverted, it does not carry out the test and a screen similar to the one reported to the side is displayed. Check the connection of measuring cables

$\Delta V\%$	15/10 – 18:04	
$\Delta V\%$	= --- %	
ZL-N	= --- $\Omega$	
FREQ.= 50.00Hz		
VL-PE= 232V VL-N= 1V		
<b>Exchange L-PE</b>		
L-N	16A 4% 0.12 $\Omega$	
<b>MODE</b>	Inom	Lim. Z> $\phi$ <

11. If the instrument detects a VL-PE, VL-N or VN-PE >5V during the test leads calibration operation it does not carry out the test and a screen similar to the one reported to the side is displayed. Check the connection of measuring cables

$\Delta V\%$	15/10 – 18:04	
RL	= --- $\Omega$	
RN	= --- $\Omega$	
RPE	= --- $\Omega$	
FREQ.= 50.00Hz		
VL-PE= 232V VL-N= 231V		
<b>V. Input &gt; 5V</b>		
CAL		
<b>MODE</b>		



## 7. STORING RESULTS

The instrument allows saving max 999 measured values. The saved data can be recalled to the display and deleted at any moment, and, upon saving, they can be associated with up to a maximum of 3 levels of numeric markers relevant to the installation name, the PV string and the PV module (with max value 250). For each level, 20 marker names are available, which can be customized by the user, if needed, **through PC connection with the provided management software**. It is also possible to add a comment associated with each measure.

### 7.1. SAVING MEASURES

1. Press the **SAVE/ENTER** key with the measured result on the display. The screen to the side appears on the display. It contains:

- Item “Measurement” which identifies the first available memory location
- The first marker (e.g.: “Installation”) to which a numeric value between 1 ÷ 250 can be associated
- The second marker (e.g.: “String”) to which a numeric value between 0 (- - -) ÷ 250 can be associated
- The third marker (e.g.: “Module”) to which a numeric value between 0 (- - -) ÷ 250 can be associated
- Item “Comment” associated with the measure, in which a text of **max 30 digits** can be entered.

SAVE	15/10 – 18:04	■
Measure	003	
Installation	<b>001</b>	
String	---	
Module	---	
Comment:	max 30 digits	

2. Use the arrow keys ◀ or ▶ to select the marker and the arrow keys (▲, ▼) to change the label of the associated numeric value (e.g.: “Area”) among those available or customizable by the user (max 20 names).

3. Select item “Comment” and press the **SAVE/ENTER** key to enter the desired text. The following screen with virtual keyboard appears on the display:

SAVE	15/10 – 18:04	■
Measure	003	
<b>Area</b>	001	
String	---	
Module	---	
<b>Comment:</b>	max 30 digits	

4. Use the arrow keys ◀ or ▶ to move the cursor to the selected digit and press the **SAVE/ENTER** key to enter comment.

5. Move the cursor to “DEL” and press the **SAVE/ENTER** key to delete the selected digit.

6. Move the cursor to “END” and press the **SAVE/ENTER** key to confirm the written comment and go back to the previous screen.

SAVE	15/10 – 18:04	■
Keyboard		
COMMENT		
0 1 2 3 4 5 6 7 8 9 0 ( ) %		
Q W E R T Y U I <b>█</b> P <=> #		
A S D F G H J K L + - * / &		
Z X C V B N M . , ; : ! ? _		
Ä Ö Ü ß µ Ñ Ç Á Í Ó Ú Û Ü ; i		
Á È É Û Ç Ä Ë Ì Ö Ù Æ Ø Å		
CANC		<b>END</b>

7. Press the **SAVE/ENTER** key to confirm saving the measure or **ESC/MENU** to exit without saving.



## 7.2. RECALL OF DATA TO DISPLAY AND MEMORY DELETION

- Position the cursor onto **MEM** by using the arrow keys (**▲**, **▼**) and confirm with **ENTER**. The screen to the side appears on the display. The screen contains:
  - The number of the memory location where the measure is saved
  - The date in which the measure was saved
  - The type of measure saved
  - The total number of saved measures for each screen and the residual available memory

MEM		15/10 – 18:04	
N.	Date	Type	
001	14/01/21	RPE	
002	15/01/21	MΩ	
003	15/01/21	LoΩ	
004	15/01/21	LoZ	
005	16/01/21	Auto	
006	17/01/21	Loop	
007	19/01/21	ΔV%	
Tot: 007		Free: 992	
↑↓	↑↓	All	
Rec	Pag	DEL	

- Use the arrow keys (**▲**, **▼**) to select the measure to be recalled to display.
- Press the **SAVE/ENTER** key to display the saved measure. Press the **ESC/MENU** key to go back to the previous screen.
- Use the arrow keys **◀** or **▶** to select option “Pag” and proceed to the next screen.
- Select the option “DEL” to delete the whole content of the instrument's memory (“All” option) or the last saved data (“Last” option). The following screen appears on the display:

MEM		15/02 – 18:04	
N.	Date	Type	
001	14/01/21	RPE	
002	15/01/21	MΩ	
003	15/01/21	LoΩ	
004	15/01/21	LoZ	
005	16/01/21	Auto	
006	17/01/21	Loop	
007	19/01/21	ΔV%	
Tot: 007		Free: 992	
↑↓	↑↓	All	
Rec	Pag	DEL	

- Press the **SAVE/ENTER** key to confirm data deletion. The message “**Memory empty**” is shown on the display.
- Press the **MENU/ESC** key to exit the function and go back to the general menu.

MEM		15/10 – 18:04	
DELETE ALL?			
ENTER / ESC			

## 8. CONNECTING THE INSTRUMENT TO THE PC

### CAUTION



- The connection between instrument and PC is realized by means of cable C2006.
- In order to transfer the data onto a PC, it is necessary to install beforehand both the management software and the drivers of cable C2006 on the PC itself.
- Before connecting, it is necessary to select the port to be used and the correct baud rate (57600 bps) on the PC. To set these parameters, launch the provided management software and refer to the program's on-line help.
- The selected port must not be engaged by other devices or applications, e.g. a mouse, a modem, etc. Close any applications running using the Microsoft Windows Task Manager function, if necessary.
- The optical port emits invisible LED radiations. Do not directly observe with optical instruments. Class 1M LED apparatus according to standard IEC/EN 60825-1.

To transfer data to the PC, follow this procedure:

1. Switch on the instrument by pressing the **ON/OFF** key.
2. Connect the instrument to the PC via the provided optical/USB cable **C2006**.
3. Press the **ESC/MENU** key to open the main menu.
4. Use the arrow keys (**▲**, **▼**) to select "**PC**", to access data transfer mode and confirm with **SAVE/ENTER**.

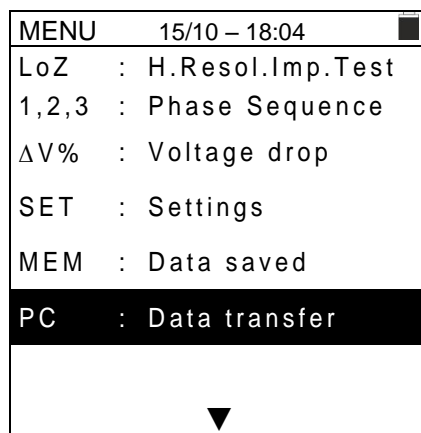

5. The instrument shows the following screen:

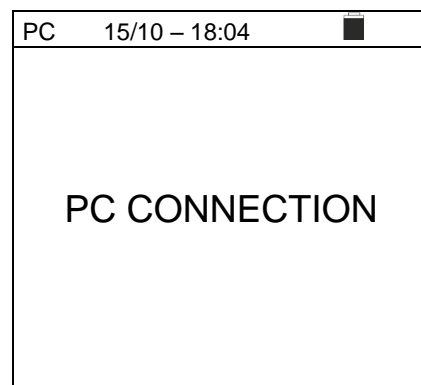

6. Use the software controls to activate data transfer (please refer to the on-line help of the program).

## 9. MAINTENANCE

### 9.1. GENERAL INFORMATION

- While using and storing the instrument, carefully observe the recommendations listed in this manual in order to prevent possible damage or danger during use.
- Do not use the instrument in environments with high humidity levels or high temperatures. Do not expose to direct sunlight
- Always switch off the instrument after use. Should the instrument remain unused for a long time, remove the batteries to avoid liquid leaks that could damage the instruments internal circuits.

### 9.2. REPLACEMENT OF THE BATTERIES

When the LCD display shows the low battery symbol “”, replace the alkaline batteries.

#### CAUTION



Only expert and trained technicians should perform this operation. Before carrying out this operation, make sure you have disconnected all cables from the input terminals.

1. Switch off the instrument by pressing the **ON/OFF** key.
2. Remove the cables from the input leads
3. Loosen the battery compartment cover fastening screw and remove the cover.
4. Remove all the batteries from the battery compartment and replace them with new batteries of the right type only (§ 10.3) making sure to respect the indicated polarities
5. Restore the battery compartment cover into place and fasten it by mean of the relevant screw.
6. Do not scatter old batteries into the environment. Use the relevant containers for disposal

### 9.3. CLEANING THE INSTRUMENT

Use a soft and dry cloth to clean the instrument. Never use wet cloths, solvents, water, etc.

### 9.4. END OF LIFE



**CAUTION:** the symbol on the instrument indicates that the appliance and its accessories must be collected separately and correctly disposed of.

## 10. TECHNICAL SPECIFICATIONS

Accuracy is calculated as:  $\pm[\% \text{reading} + (\text{no. of digits}) * \text{resolution}]$  at 23°C, <80%RH

### 10.1. TECHNICAL CHARACTERISTICS

#### AC TRMS voltage

Range [V]	Resolution [V]	Accuracy
15 ÷ 460	1	$\pm(3\% \text{rdg} + 2 \text{dgt})$

#### Frequency

Range [Hz]	Resolution [Hz]	Accuracy
47.0 ÷ 63.6	0.1	$\pm(0.1\% \text{rdg} + 1 \text{dgt})$

#### Continuity of protective conductor (RPE)

Range [ $\Omega$ ]	Resolution [ $\Omega$ ]	Accuracy
0.00 ÷ 9.99	0.01	$\pm(5.0\% \text{rdg} + 3 \text{dgt})$
10.0 ÷ 99.9	0.1	
100 ÷ 1999	1	

Test current: >200mA DC up to 5 $\Omega$  (test leads included)

Test current generated: 1mA resolution, range 0 ÷ 250mA

Tensione a vuoto: 4 < V<sub>0</sub> < 24VDC

Safety protection: error message for input voltage >10V

#### Insulation resistance (M $\Omega$ )

Test voltage [V]	Range [M $\Omega$ ]	Resolution [M $\Omega$ ]	Accuracy
50	0.01 ÷ 9.99	0.01	$\pm(2.0\% \text{rdg} + 2 \text{dgt})$
	10.0 ÷ 49.9	0.1	$\pm(5.0\% \text{rdg} + 2 \text{dgt})$
	50.0 ÷ 99.9		
100	0.01 ÷ 9.99	0.01	$\pm(2.0\% \text{rdg} + 2 \text{dgt})$
	10.0 ÷ 99.9	0.1	$\pm(5.0\% \text{rdg} + 2 \text{dgt})$
	100 ÷ 199	1	
250	0.01 ÷ 9.99	0.01	$\pm(2.0\% \text{rdg} + 2 \text{dgt})$
	10.0 ÷ 199.9	0.1	$\pm(5.0\% \text{rdg} + 2 \text{dgt})$
	200 ÷ 249		
500	250 ÷ 499	1	
	0.01 ÷ 9.99	0.01	$\pm(2.0\% \text{rdg} + 2 \text{dgt})$
	10.0 ÷ 199.9	0.1	$\pm(5.0\% \text{rdg} + 2 \text{dgt})$
200 ÷ 499	1		
1000	500 ÷ 999	1	
	0.01 ÷ 9.99	0.01	$\pm(2.0\% \text{rdg} + 2 \text{dgt})$
	10.0 ÷ 199.9	0.1	$\pm(5.0\% \text{rdg} + 2 \text{dgt})$
200 ÷ 1999	1		

Open-circuit voltage: rated test voltage -0% +10%

Rated measuring current: >1mA with 1k $\Omega$  x V<sub>nom</sub> (50V, 100V, 250V, 1000V), >2.2mA with 230k $\Omega$  @ 500V

Short-circuit current: <6.0mA for each test voltage

Safety protection: error message for input voltage >10V

#### Line/Loop impedance (Phase-Phase, Phase-Neutral, Phase-Earth)

Range [ $\Omega$ ]	Resolution [ $\Omega$ ]	Accuracy (*)
0.01 ÷ 9.99	0.01	$\pm(5\% \text{rdg} + 3 \text{dgt})$
10.0 ÷ 199.9	0.1	

(\*) 0.1m $\Omega$  in range 0.1 ÷ 199.9 m $\Omega$  (by using the optional accessory IMP57)

Maximum test current: 3.31A (at 265V); 5.71A (at 457V)

P-N/P-P Test voltage: (100V  $\pm$  265V) / (100V  $\pm$  460V); 50/60Hz  $\pm$  5%

Protection types: MCB (B, C, D, K), Fuse (aM, gG, BS882-2, BS88-3, BS3036, BS1362)

#### First fault current – IT systems

Range [mA]	Resolution [mA]	Accuracy
0.1 ÷ 0.9	0.1	$\pm(5\% \text{rdg} + 1 \text{dgt})$
1 ÷ 999	1	$\pm(5\% \text{rdg} + 3 \text{dgt})$

Limit contact voltage (ULIM) : 25V, 50V

**Test on RCD protection (Molded case type)**

Differential protection type (RCD): AC (⌚), A (⌚), General (G), Selective (S) and B (⌚)

Voltage range Phase-Earth, Phase-Neutral: 100V ±265V RCD type AC and A, 190V ±265V RCD type B

Rated tripping currents (I<sub>ΔN</sub>): 6mA, 10mA, 30mA, 100mA, 300mA, 500mA, 650mA, 1000mA

Frequency: 50/60Hz ± 5%

**Molded case type RCD tripping current - (for General RCD only)**

RCD type	I <sub>ΔN</sub>	Range I <sub>ΔN</sub> [mA]	Resolution [mA]	Accuracy
AC, A, B	6mA, 10mA	(0.2 ÷ 1.1) I <sub>ΔN</sub>	≤ 0.1 I <sub>ΔN</sub>	- 0%, +10% I <sub>ΔN</sub>
AC, A, B	30mA ≤ I <sub>ΔN</sub> ≤ 300mA			- 0%, +5% I <sub>ΔN</sub>
AC, A	500mA ≤ I <sub>ΔN</sub> ≤ 650mA			- 0%, +5% I <sub>ΔN</sub>

**Measurement duration of Molded case type RCD tripping time – TT/TN systems**

	x 1/2		x 1		x 5		AUTO				AUTO+	
	\	G	S	G	S	G	S	G	S	G	S	
6mA	AC	999	999	999	999	50	150	✓	✓	310		✓
	A	999	999	999	999	50	150	✓	✓	310		✓
	B	999	999	999	999					310		
10mA	AC	999	999	999	999	50	150	✓	✓	310		✓
	A	999	999	999	999	50	150	✓	✓	310		✓
	B	999	999	999	999					310		
30mA	AC	999	999	999	999	50	150	✓	✓	310		✓
	A	999	999	999	999	50	150	✓	✓	310		✓
	B	999	999	999	999					310		
100mA	AC	999	999	999	999	50	150	✓	✓	310		
	A	999	999	999	999	50	150	✓	✓	310		
	B	999	999	999	999					310		
300mA	AC	999	999	999	999	50	150	✓	✓	310		
	A	999	999	999	999	50	150	✓	✓	310		
	B	999	999	999	999					310		
500mA 650mA	AC	999	999	999	999	50	150	✓	✓	310		
	A	999	999	999	999					310		
	B											
1000mA	AC	999	999	999								
	A	999	999	999								
	B											

Table with duration of tripping time measurement [ms] - Resolution: 1ms, Accuracy: ±(2.0% reading + 2 digits)

**Measurement duration of Molded case type RCD tripping time – IT systems**

	x 1/2		x 1		x 5		AUTO				AUTO+	
	\	G	S	G	S	G	S	G	S	G	S	
6mA	AC	999	999	999	999	50	150	✓	✓	310		✓
10mA	A	999	999	999	999	50	150	✓	✓	310		✓
30mA	B	999	999	999	999					310		
100mA 300mA	AC	999	999	999	999	50	150	✓	✓	310		
	A	999	999	999	999	50	150	✓	✓	310		
	B	999	999	999	999					310		
500mA 650mA	AC	999	999	999	999	50	150	✓		310		
	A	999	999	999	999			✓		310		
	B											
1000mA	AC	999	999	999	999							
	A	999	999	999	999							
	B											

Table with duration of tripping time measurement [ms] - Resolution: 1ms, Accuracy: ±(2.0% reading + 2 digits)

**Overall earth resistance without RCD tripping ( $R_{a\frac{1}{2}}$ )**

 Voltage range Phase-Earth, Phase-Neutral:  $100 \div 265V$ , Frequency:  $50/60Hz \pm 5\%$ 
**Global earth resistance in systems with Neutral (3-wire) – (30mA or higher RCD)**

Range [ $\Omega$ ]	Resolution [ $\Omega$ ]	Accuracy
$0.05 \div 9.99$	0.01	$\pm(5\%rdg + 8dgt)$
$10.0 \div 199.9$	0.1	

**Global earth resistance in systems with Neutral (3-wire) – (6mA and 10mA RCD)**

Range [ $\Omega$ ]	Resolution [ $\Omega$ ]	Accuracy
$0.05 \div 9.99$	0.01	$\pm(5\%rdg + 30dgt)$
$10.0 \div 199.9$	0.1	

**Global earth resistance in systems without Neutral (2-wire) – (30mA or higher RCD)**

Range [ $\Omega$ ]	Resolution [ $\Omega$ ]	Accuracy
$0.05 \div 9.99$	0.01	$\pm(5\%rdg + 8dgt)$
$10.0 \div 99.9$	0.1	
$100 \div 1999$	1	

**Global earth resistance in systems without Neutral (2-wire) – (6mA and 10mA RCD)**

Range [ $\Omega$ ]	Resolution [ $\Omega$ ]	Accuracy
$0.05 \div 9.99$	0.01	$\pm(5\%rdg + 30dgt)$
$10.0 \div 99.9$	0.1	
$100 \div 1999$	1	

**Contact voltage (measured during RCD and  $R_{a\frac{1}{2}}$  test)**

Range [V]	Resolution [V]	Accuracy
$0 \div U_t LIM$	0.1	$-0\%, +(5.0\% rdg + 3V)$

**Phase rotation with 1 test lead**

Voltage range P-N, P-PE[V]	Frequency range
$100 \div 265$	$50Hz/60Hz \pm 5\%$

 Measurement is only carried out by direct contact with metal live parts (**not on insulation sheath**).

## 10.2. REFERENCE GUIDELINES

Safety:	IEC/EN61010-1, IEC/EN61557-1, -2, -3, -4, -6, -7, -10
EMC :	IEC/EN61326-1
Technical documentation:	IEC/EN61187
Safety of accessories:	IEC/EN61010-031, IEC/EN61010-2-032, IEC/EN61010-2-030, IEC/EN61010-2-033, IEC/EN61010-2-034
Insulation:	double insulation
Pollution level:	2
Max operating altitude:	2000m (6562ft)
Measurement category:	CAT IV 300V to earth, maximum 415V between inputs
RPE:	IEC/EN61557-4, BS7671 17th/18th ed., AS/NZS3000/3017
MΩ:	IEC/EN61557-2, BS7671 17th/18th ed., AS/NZS3000/3017
RCD:	IEC/EN61557-6 (only on Phase-Neutral-Earth systems)
LOOP P-P, P-N, P-PE:	IEC/EN61557-3, BS7671 17th/18th ed., AS/NZS3000/3017
123:	IEC/EN61557-7, BS7671 17th ed., AS/NZS3000/3017
Multifunction:	IEC/EN61557-10, BS7671 17th/18th ed., AS/NZS3000/3017
Short circuit current :	EN60909-0

## 10.3. GENERAL CHARACTERISTICS

### Mechanical characteristics

Dimensions (L x W x H):	225 x 165 x 75mm ; (9 x 6 x 3in)
Weight (batteries included):	1.2kg ; (42 ounces)
Mechanical protection:	IP40

### Power supply

Battery type:	6x1.5V alkaline batteries type AA IEC LR06 MN1500
Low battery indication:	low battery symbol  on the display
Battery life:	> 500 tests for each function
Auto Power OFF:	after 5 minutes idling (if activated)

### Miscellaneous

Display:	COG Black/white graphic LCD, 320x240pxl
----------	---

## 10.4. ENVIRONMENT

### 10.4.1. Environmental conditions for use

Reference temperature:	23°C ± 5°C ; (73°F ± 41°F)
Operating temperature:	0°C ÷ 40°C ; (32°F ÷ 104°F)
Allowable relative humidity:	<80%RH
Storage temperature:	-10°C ÷ 60°C ; (14°F ÷ 140°F)
Storage humidity:	<80%RH

**This instrument satisfies the requirements of Low Voltage Directive 2014/35/EU (LVD) and of EMC Directive 2014/35/EU**  
**This instrument satisfies the requirements of European Directive 2011/65/EU (RoHS) and 2012/19/EU (WEEE)**

## 11. SERVICE

### 11.1. WARRANTY CONDITIONS

This instrument is warranted against any material or manufacturing defect, in compliance with the general sales conditions. During the warranty period, defective parts may be replaced. However, the manufacturer reserves the right to repair or replace the product. Should the instrument be returned to the After-sales Service or to a Dealer, transport will be at the Customers charge. However, shipment will be agreed in advance. A report will always be enclosed to a shipment, stating the reasons for the products return. Only use original packaging for shipment. Any damage due to the use of non-original packaging material will be charged to the Customer. The manufacturer declines any responsibility for injury to people or damage to property.

The warranty shall not apply in the following cases:

- Repair and/or replacement of accessories and battery (not covered by warranty).
- Repairs that may become necessary as a consequence of an incorrect use of the instrument or due to its use together with non-compatible appliances.
- Repairs that may become necessary as a consequence of improper packaging.
- Repairs which may become necessary as a consequence of interventions performed by unauthorized personnel.
- Modifications to the instrument performed without the manufacturer's explicit authorization.
- Use not provided for in the instruments specifications or in the instruction manual.

The content of this manual cannot be reproduced in any form without the manufacturer's authorization.

**Our products are patented and our trademarks are registered. The manufacturer reserves the right to make changes in the specifications and prices if this is due to improvements in technology.**

### 11.2. SERVICE

If the instrument does not operate properly, before contacting the After-sales Service, please check the conditions of batteries and cables and replace them, if necessary. Should the instrument still operate improperly, check that the product is operated according to the instructions given in this manual. Should the instrument be returned to the After-sales Service or to a Dealer, transport will be at the Customer's charge. However, shipment will be agreed in advance. A report will always be enclosed to a shipment, stating the reasons for the products return. Only use original packaging for shipment; any damage due to the use of non-original packaging material will be charged to the Customer.



## 12. THEORETICAL APPENDIXES

### 12.1. CONTINUITY OF PROTECTIVE CONDUCTORS

Check the continuity of:

- Protective conductors (PE), main equalizing potential conductors (EQP), secondary equalizing potential conductors (EQS) in TT and TN-S systems
- Neutral conductors having functions of protective conductors (PEN) in TN-C system.

This test is to be preceded by a visual check verifying the existence of yellow-green protective and equalizing potential conductors as well as compliance of the sections used with the standards requirements.

#### Parts of the system to be checked

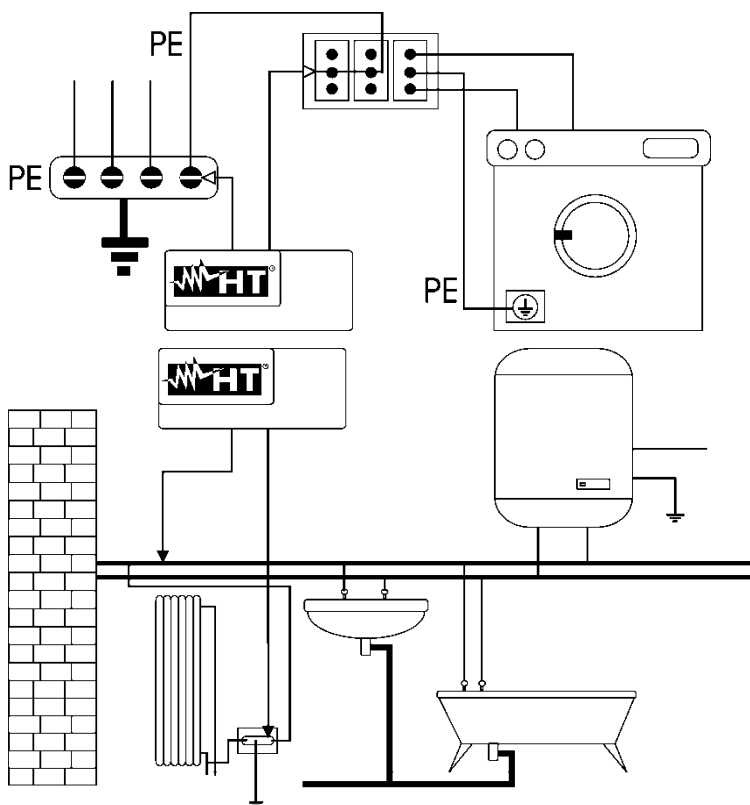

Connect one of the test leads to the protective conductor of the socket and the other to the equalizing potential node of the earth installation.

Connect one of the test leads to the external mass (in this case the water pipe) and the other to the earth installation using for example the protective conductor of the closest socket.

Fig. 35: Examples for continuity measurements on conductors

Check the continuity among:

- Earth poles of all the plug sockets and earth collector or node
- Earth terminals of class I appliances (boilers, etc.) and earth collector or node
- Main external masses (water tubes, gas pipes, etc.) and earth collector or node
- Additional external masses between each other and to earth terminal.

#### Allowable values

The standards do not require the measurement of continuity resistance and the comparison of the results with limit values. The standards simply require that the instrument in use warns the operator if the test was not carried out with a current of at least 200mA and an open circuit voltage ranging from 4 to 24V. The resistance values may be calculated according to the sections and lengths of the conductors under test. In general, if the instrument detects values of some ohms, the test may be considered as successful.

## 12.2. INSULATION RESISTANCE

### Purpose of the test

Check that the insulation resistance of the installation complies with the requirements of the applicable guidelines. This test has to be performed with the circuit being tested not powered and with the possible loads it supplies disconnected.

### **Allowable values**

The values of the measured voltage and of the minimum insulation resistance can be taken from the following table

<b>Circuit nominal voltage [V]</b>	<b>Test voltage [V]</b>	<b>Insulation resistance [MΩ]</b>
SELV and PELV *	250	≥ 0,250
Up to/equal to 500 V, except for the above-mentioned circuits	500	≥ 1,000
Over 500 V	1000	≥ 1,000

\* The terms SELV and PELV replace, in the standards new wording, the old definitions of “Very low safety voltage” or “Very low functional voltage”

Table 3: Most common test types, insulation resistance measurement

### **Parts of the system to be checked**

Check that the insulation resistance between:

- Each active conductor and the earth (the neutral conductor is considered as an active conductor except in TN-C power supply systems, where it is considered as part of the earthing (PEN)). During this measurement, all active conductors may be connected to each other. Should the measurement result not to be within the limits prescribed by the standards, the test must be repeated separately for each single conductor
- The active conductors. The guidelines recommends also checking the insulation between active conductors when this is possible

If the system includes electronic devices, it is necessary to disconnect them from the system to prevent any damage. Should this not be possible, only perform the test between active conductors (which, in this case, must be connected to each other) and the earth connection.

In the presence of a very extended circuit, wires running side by side constitute a capacity that the instrument must load in order to obtain a correct measurement; in this case it is advisable to hold the start button of the measurement (in case you run the test in manual mode) until the result is stable.

The "**> full scale**" message indicates that the insulation resistance measured by the instrument is higher than the maximum measurable resistance, this result is obviously much higher than the minimum limits in the standard table above, so the insulation at that point is to be considered compliant

## **12.3. CHECKING CIRCUIT SEPARATION**

A **SELV** system is a zero-category system or safety extra low voltage system characterized by power supply from an independent (e.g. batteries, small generator set) or safety source (e.g. safety transformer), protective separation from other electrical systems (double or reinforced insulation or earthed metal screen) and absence of earthed points (insulated from the earth).

A **PELV** system is a zero-category system or protective extra low voltage system characterized by power supply from an independent (e.g. batteries, small generator set) or safety source (e.g. safety transformer), protective separation from other electrical systems (double or reinforced insulation or earthed metal screen) and, unlike **SELV** systems, presence of earthed points (not insulated from the earth).

A system with **Electrical Separation** is a system characterized by a power supply from an insulation transformer or independent source with equivalent characteristics (e.g. motor generator set), protective separation from other electrical systems (insulation no lower than that of the insulation transformer), protective separation to earth (insulation no lower than that of the insulation transformer).

### **Purpose of the test**

The test, to be performed if protection is obtained through separation must check that the insulation resistance measured as described below (according to the type of separation) complies with the limits reported in the table relating to insulation measurements.

### **Parts of the system to be checked**

- **SELV System (Safety Extra Low Voltage):**
  - ✓ Measure the resistance between the active parts of the circuit being tested (separated) and the active parts of the other circuits.
  - ✓ Measure the resistance between the active parts of the circuit to be tested (separated) and the earth.
  
- **PELV System (Protective Extra Low Voltage):**
  - ✓ Measure the resistance between the active parts of the circuit being tested (separated) and the active parts of the other circuits.
  
- **Electrical separation:**
  - ✓ Measure the resistance between the active parts of the circuit being tested (separated) and the active parts of the other circuits.
  - ✓ Measure the resistance between the active parts of the circuit to be tested (separated) and the earth.

### **Allowable values**

The test has a positive result when the insulation resistance shows values higher or equal to those indicated in **Fejl! Henvisningskilde ikke fundet..**

### EXAMPLE OF SEPARATION TEST BETWEEN ELECTRICAL CIRCUITS

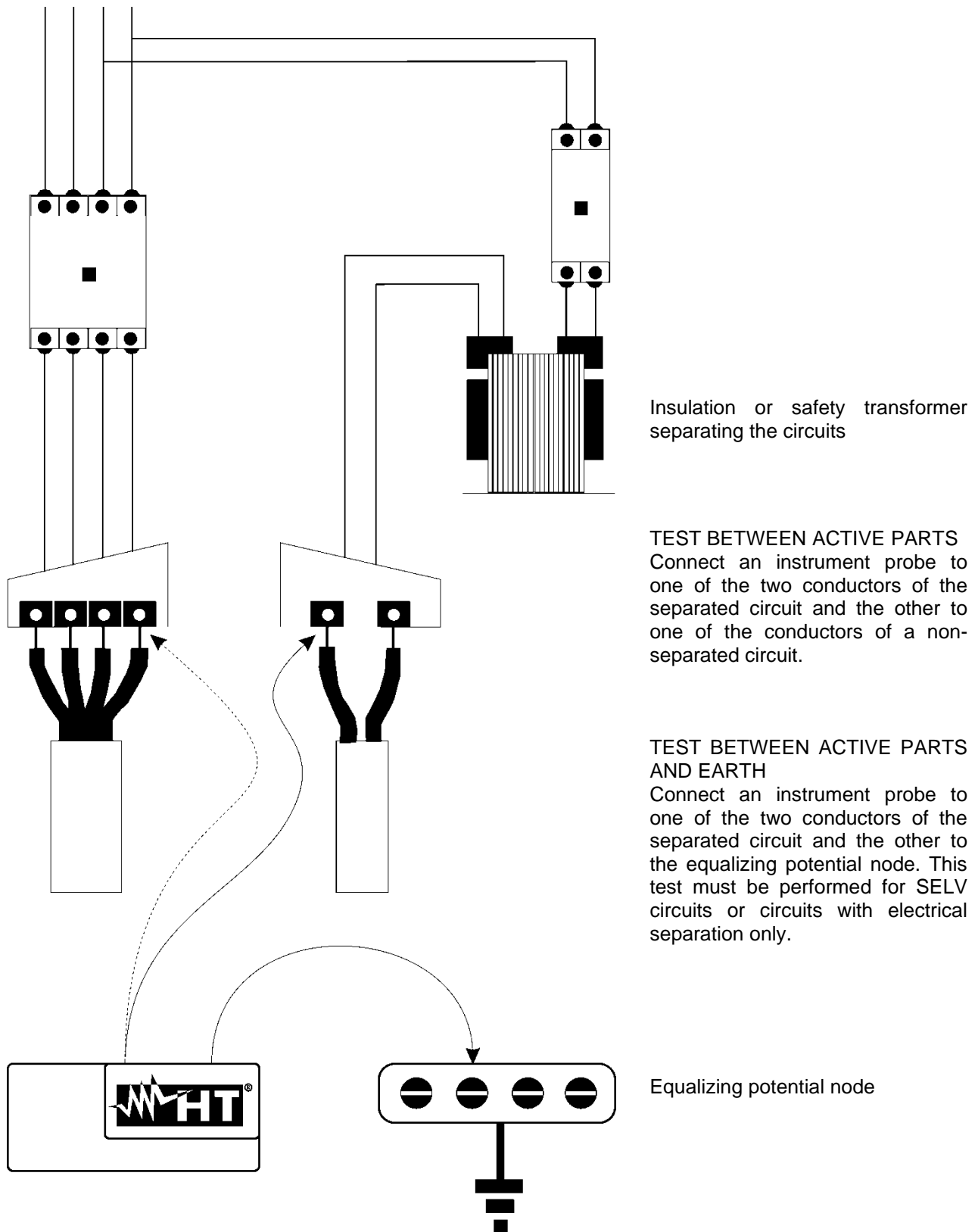

Fig. 36: Separation measurements between the circuits of a system

## 12.4. TEST ON DIFFERENTIAL SWITCHES (RCD)

### Purpose of the test

Checking that the General (G) and Selective (S) differential protection devices have been correctly installed and adjusted and that they maintain their characteristics over time. The check must make sure that the differential switch trips at a current not higher than its nominal operating current  $I_{dN}$  and that the tripping time meets the following conditions, according to the case:

- The tripping time does not exceed the maximum time as prescribed by the standard for differential switches of a General type (according to what described in Table 4).
- The tripping time is between the minimum and the maximum tripping time for differential switches of a Selective type (according to what described in Table 4).

The differential switch test performed with the test key helps so that no “gluing effect” jeopardizes the operation of the device if it has remained unused for a long time. This test is only performed to ascertain the mechanical functionality of the device and it is not sufficient to declare the devices conformity to the standard regarding differential current devices. According to statistics, switch verification through test key, if performed once a month, reduces to a half the devices malfunction rate. However, this test only detects 24% of the defective differential switches.

### Parts of the system to be checked

All differential switches must be tested upon installation. In low-voltage systems, it is advisable to perform this test, fundamental in order to guarantee a correct safety level. In medical rooms, this test must be performed periodically on all differential switches as prescribed by the guidelines.

### Allowable values

On each molded type RCD two tests must be performed on each differential switch: a test with a leakage current beginning in phase with the positive half-wave of voltage ( $0^\circ$ ) and a test with a leakage current beginning in phase with the negative half-wave of voltage ( $180^\circ$ ). The result to be considered is the higher one. The test with  $\frac{1}{2}I_n$  must not cause the differential switch tripping.

RCD type	$I_{dN} \times 1$	$I_{dN} \times 5^*$	Description
General	0.3s	0.04s	Maximum tripping time in seconds
Selective S	0.13s	0.05s	Minimum tripping time in seconds
	0.5s	0.15s	Maximum tripping time in seconds

Table 4: Tripping times for general and selective differential switches

### **Trip-out times compliance with AS/NZS 3017 guideline (\*\*)**

RCD type	$I_{dN}$ [mA]	$\frac{1}{2} I_{\Delta n}$ (*)	$I_{\Delta n}$	$5 \times I_{\Delta n}$	Note
		$t\Delta$ [ms]			
I	$\leq 10$	>999ms	40		Maximum tripping time
II	$> 10 \leq 30$		300	40	
III	$> 30$		500	150	
IV [S]	$> 30$		130	50	Minimum non-actuating time

Table 5: Tripping times for general and selective differential switches in AUS/NZ country

(\*) Minimum test period for current of  $\frac{1}{2} I_{\Delta n}$ , RCD shall no trip-out

(\*\*) Test current and measurement accuracy correspond to AS/NZS 3017 requirements

## Measurement of tripping current for protection differential switches

- This test aims at checking the real tripping current of general differential switches (**it does not apply to selective differential switches**).
- In the presence of differential switches with selectable tripping current, it is useful to perform this test in order to check the real tripping current of the differential switch. For differential switches with fixed differential current, this test may be performed in order to detect possible leakages of the users connected to the system.
- Should an earth system not be available, perform the test by connecting the instrument to a terminal on a conductor downstream of the differential device and a terminal on the other conductor upstream of the device.
- Tripping current must be between  $\frac{1}{2}I_{dn}$  and  $I_{dn}$

## 12.5. VERIFY OF THE BREAKING CAPACITY OF PROTECTION DEVICES

### Purpose of the test

Checking that the breaking capacity of the protection device is higher than the maximum fault current possible in the system.

### Parts of the system to be checked

The test must be performed at the point in which the maximum short-circuit current is possible, normally immediately downstream of the protection device to be checked.

The test must be performed between phase and phase ( $Z_{pp}$ ) in three-phase systems and between phase and neutral ( $Z_{pn}$ ) in single-phase systems.

### Allowable values

The instrument performs the comparison between the measured value and the value calculated according to the following relationships:

$$BC > I_{MAX\ 3\Phi} = C_{MAX} \cdot \frac{\frac{U_{L-L}^{NOM}}{\sqrt{3}}}{\frac{Z_{L-L}}{2}}$$

**Three-phase systems**

$$BC > I_{MAX\ L-N} = C_{MAX} \cdot \frac{U_{L-N}^{NOM}}{Z_{L-N}}$$

**Single-phase systems**

where: BC = breaking capacity of protection device  
 $Z_{LL}$  = Impedance measured between phase and phase  
 $Z_{LN}$  = Impedance measured between phase and neutral

Measured voltage	$U_{NOM}$	$C_{MAX}$
$230V-10\% < V_{measured} < 230V+10\%$	230V	1.05
$230V+10\% < V_{measured} < 400V-10\%$	$V_{measured}$	1.10
$400V-10\% < V_{measured} < 400V+10\%$	400V	1.05

## 12.6. VERIFY OF PROTECTION AGAINST INDIRECT CONTACTS IN TN SYSTEMS

### Purpose of the test

The protection against indirect contacts in the TN systems must be guaranteed by means of a protection device against the overcurrents (typically MCB or fuse) which switch off the power supply of the circuit or the electrical equipment in case of a fault between an active part and a ground mass or a protection conductor within an interval not exceeding 5s, sufficient for the equipments, or in compliance with the times declared in the following table. For other countries refer to the respective guidelines.

U <sub>0</sub> [V]	Trip out time of protection [s]
50 ÷ 120	0.8
120 ÷ 230	0.4
230 ÷ 400	0.2
>400	0.1

Table 6: Tripping times for protection devices

U<sub>0</sub> = nominal AC voltage refer to ground of the system

The above conditions is satisfied by the following relationship:

$$Z_s \cdot I_a \leq U_0$$

where:

- Z<sub>s</sub> = Fault Loop P-PE impedance which includes the phase winding of the transformer, the line conductor up to the fault point and the protective conductor from the fault point to the star center of the transformer
- I<sub>a</sub> = Tripping current of the protection device within the specified time in Table 6
- U<sub>0</sub> = nominal AC voltage refer to ground

### CAUTION



The instrument must be used to measure fault loop impedance values at least 10 times higher than the resolution value of the instrument in order to minimize errors.

### Parts of the system to be checked

The test must necessarily be performed on TN and IT systems not protected by differential devices.

### Allowable values

The measurement is aimed at ensuring that in every point of the system the followed relationships are satisfied:

$$I_a \leq I_{MIN P-PE} = C_{MIN} \cdot \frac{U_{P-PE}^{NOM}}{Z_{P-PE}}$$

Measured voltage	U <sub>NOM</sub>	C <sub>MIN</sub>
230V-10% < V <sub>measured</sub> < 230V+ 10%	230V	0.95
230V+10% < V <sub>measured</sub> < 400V- 10%	V <sub>measured</sub>	1.00
400V-10% < V <sub>measured</sub> < 400V+ 10%	400V	0.95

Depending on the set values of phase-phase, phase-neutral or phase-PE voltage (see § 5.1.3) and the measured value of fault loop impedance, the instrument calculates the **minimum value** of the assumed short-circuit current to be interrupted by the protection device. For proper coordination, this value **MUST** always be greater than or equal to the **I<sub>a</sub>** value of the tripping current of the type of protection considered.

The **I<sub>a</sub>** reference value (see Fig. 37) depends on:

- Protection type (curve)
- Rated current of the protection device
- Time of fault extinction by the protection

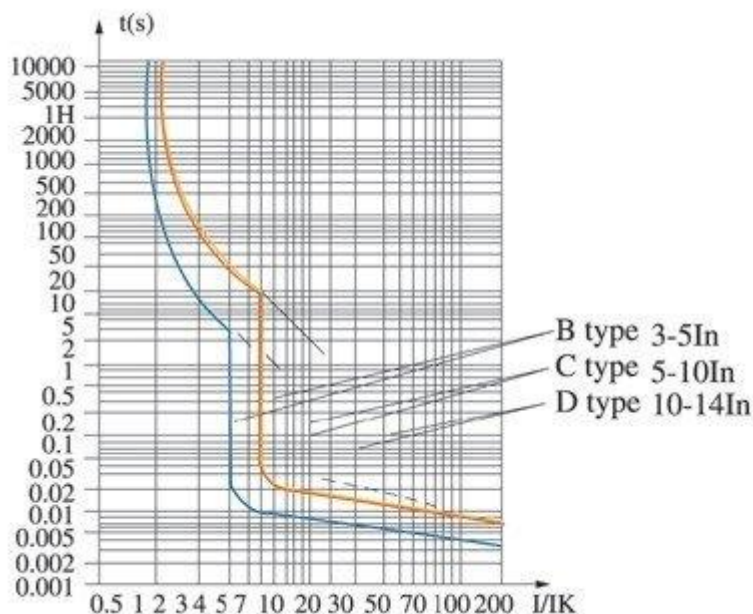

Fig. 37: Example of curves relative to magnetothermal (MCB) protection

The instrument allows the selection (\*) of the following parameters:

- **MCB curve B** → 3A, 6A, 10A, 13A, 15A, 16A, 20A, 25A, 32A, 40A, 45A, 50A, 63A, 80A, 100A, 125A, 160A, 200A
- **MCB curve C** → 0.5A, 1A, 1.6A, 2A, 3A, 4A, 6A, 10A, 13A, 15A, 16A, 20A, 25A, 32A, 40A, 50A, 63A, 80A, 100A, 125A, 160A, 200A
- **MCB curve D, K** → 0.5A, 1A, 1.6A, 2A, 3A, 4A, 6A, 10A, 13A, 15A, 16A, 20A, 25A, 32A, 40A, 45A, 50A, 63A, 80A, 100A, 125A, 160A, 200A
- **Fuse gG** → 2A, 4A, 6A, 8A, 10A, 12A, 13A, 16A, 20A, 25A, 32A, 35A, 40A, 50A, 63A, 80A, 100A, 125A, 160A, 200A, 250A, 315A, 400A, 500A, 630A, 800A, 1000A, 1250A
- **Fuse aM** → 2A, 4A, 6A, 10A, 12A, 16A, 20A, 25A, 32A, 35A, 40A, 50A, 63A, 80A, 100A, 125A, 160A, 200A, 250A, 315A, 400A, 500A, 630A
- Time of fault extinction by the protection selectable among: **0.1s, 0.2s, 0.4s, 1s, 5s**

(\*) The values could be subject to variations



## 12.7. RA TEST IN TN SYSTEMS

The protection against indirect contacts in the TN systems must be guaranteed by means of a protection device against the overcurrents (typically MCB or fuse) which switches off the power supply of the circuit or the electrical equipment in case of a fault between an active part and a ground mass or a protection conductor within an interval not exceeding 5s, sufficient for the equipments.

### Parts of the system to be checked

The test must be performed at the point in which the minimum short-circuit current is possible, normally immediately downstream of the protection device to be checked.

The test must be performed between phase and PE ( $Z_{L-PE}$ ) and between phase and neutral ( $Z_{L-N}$ ) in three-phase systems or single-phase systems.

### Allowable values

The measurement is aimed at ensuring that in every point of the system the following relationships are satisfied:

$$Z_{L-PE} \leq Z_{LIM} \quad (1)$$

$$Z_{L-N} \leq Z_{LIM} \quad (2)$$

where:

- $Z_{L-PE}$  = Impedance measured between phase and PE
- $Z_{L-N}$  = Impedance measured between phase and neutral
- $Z_{LIM}$  = Maximum limit impedance depending on type (MCB or Fuse) and tripping time of the selected protection (values depending on countries)

The following selections (\*) are available on the instrument:

- **MCB curve B** → 3A, 6A, 10A, 13A, 15A, 16A, 20A, 25A, 32A, 40A, 45A, 50A, 63A, 80A, 100A, 125A, 160A, 200A
- **MCB curve C** → 0.5A, 1A, 1.6A, 2A, 3A, 4A, 6A, 10A, 13A, 15A, 16A, 20A, 25A, 32A, 40A, 50A, 63A, 80A, 100A, 125A, 160A, 200A
- **MCB curve D, K** → 0.5A, 1A, 1.6A, 2A, 3A, 4A, 6A, 10A, 13A, 15A, 16A, 20A, 25A, 32A, 40A, 45A, 50A, 63A, 80A, 100A, 125A, 160A, 200A
- **Fuse gG** → 2A, 4A, 6A, 8A, 10A, 12A, 13A, 16A, 20A, 25A, 32A, 35A, 40A, 50A, 63A, 80A, 100A, 125A, 160A, 200A, 250A, 315A, 400A, 500A, 630A, 800A, 1000A, 1250A
- **Fuse aM** → 2A, 4A, 6A, 10A, 12A, 16A, 20A, 25A, 32A, 35A, 40A, 50A, 63A, 80A, 100A, 125A, 160A, 200A, 250A, 315A, 400A, 500A, 630A
- Time of fault extinction by the protection selectable among: **0.1s, 0.2s, 0.4s, 1s, 5s**

(\*) The values could be subject to variations

## 12.8. VERIFY OF PROTECTION AGAINST INDIRECT CONTACTS IN TT SYSTEMS

### Purpose of the test

Checking that the protection device is coordinated with the value of earth resistance. We cannot assume a priori a reference limit value for earth resistance as a reference when checking the measurements result. It is necessary to check each time that the coordination prescribed by the standard is met.

### Parts of the system to be checked

Earth installation in operating conditions. The test must be performed without disconnecting the earth rods.

### Allowable values

The value of earth resistance, however measured, must satisfy the following relation:

$$R_A < 50 / I_a$$

where:  $R_A$  = resistance measured of earth installation whose value can be determined with the following measurements:

- Impedance of the fault ring (\*)
- Earth resistance with two wires in socket (\*\*)
- Earth resistance obtained by the measurement of contact voltage  $U_t$  (\*\*)
- Earth resistance obtained by the tripping time test of the RCDs (A, AC), RCD S (A, AC) (\*\*)

$I_a$  = tripping current of the automatic RCD or rated tripping current of the RCD (in case of RCD S 2  $I_{dN}$ ) in ampere

50 = safety limit voltage (reduced down to 25V in special environments)

(\*) If the system protection is obtained through a differential switch, the measurement must be performed upstream of this switch or downstream of it by short-circuiting the switch in order to prevent it from tripping.

(\*\*) These methods, although not currently foreseen by guidelines provide values that have been proven indicative of the earth resistance by numerous comparisons with the three-wire method.

### EXAMPLE OF EARTH RESISTANCE CHECK

System protected by a 30mA differential switch.

- Let us measure the earth resistance by using one of the above-mentioned methods.
- In order to understand if the system resistance is to be considered as compliant with the standards, we need to multiply the value found by 0.03A (30mA).
- If the result is lower than 50V (or 25V for special environments), the system can be considered as coordinated, as it satisfies the relationship indicated above.
- When dealing with 30mA differential switches (as in almost all civil systems), the maximum allowable earth resistance is  **$50/0.03=1666\Omega$** . This enables using also the indicated simplified methods which, although they do not provide an extremely precise value, provide a sufficiently approximated value for coordination calculation.

## 12.9. VERIFY OF PROTECTION AGAINST INDIRECT CONTACTS IN IT SYSTEMS

In IT systems the active parts must be isolated from the ground or be connected to earth through an impedance of sufficiently high value. In the case of a single earth fault current of the first fault is weak and therefore it is not necessary to interrupt the circuit. This connection can be made to the neutral point of the system or to an artificial neutral point. If there is no neutral point, can be connected to earth through an impedance of a line conductor. It must, however, take precautions to avoid the risk of harmful physiological effects on people in contact with conductive parts simultaneously accessible in the case of a double earth fault.

### **Purpose of the test**

Verify that the impedance of the ground probe in which the mass are connected satisfy the following relationship:

$$Z_E * I_d \leq U_L$$

where:

- $Z_E$  = L-PE impedance of the ground probe in which the mass are connected
- $I_d$  = L-PE current of first fault (typically expressed in mA)
- $U_L$  = Limit contact voltage 25V or 50V

### **Parts of the system to be checked**

The earth system under operating conditions. The verification should be performed without disconnecting the ground probes.

## 12.10. VERIFY OF PROTECTION COORDINATION L-L, L-N AND L-PE

### Purpose of the test

Test the coordination of protective devices (typically MCB or fuse) present in a Single-phase or Three-phase installation as a function of the limit time of fault extinction by the protection set by the user and the calculated value of the short-circuit current.

### Parts of the system to be checked

The test must be performed at the point in which the minimum short-circuit current is possible, normally at the end of the line controlled by the protection device in the normal condition of the line. The test must be performed between Phase-Phase in the Three-phase installations and between Phase-PE or Phase-PE in the Single-phase installation

### Allowable values

The instrument performs the comparison between the calculated value of short-circuit current and the  $I_a$  = tripping current of the protection device within the specified time, according to the following expressions:

$$I_{SCL-L\_Min\ 2\Phi} > I_a \quad \text{Three-phase system} \rightarrow \text{Loop L-L impedance}$$

$$I_{SCL-N\_Min} > I_a \quad \text{Single-phase system} \rightarrow \text{Loop L-N impedance}$$

$$I_{SCL-PE\_Min} > I_a \quad \text{Single-phase system} \rightarrow \text{Loop L-PE impedance}$$

where:

- Isc L-L\_Min2F = Prospective short-circuit current minimum double phase L-L
- Isc L-N\_Min = Prospective short-circuit current minimum L-N
- Isc L-PE\_Min = Prospective short-circuit current minimum L-PE

The calculation of prospective short-circuit current is performed by the instrument based on the fault loop impedance measurement in compliance with the following relationships:

$$I_{SCL-L\_Min\ 2\Phi} = C_{MIN} \cdot \frac{U_{L-L}^{NOM}}{Z_{L-L}} \quad I_{SCL-N\_Min} = C_{MIN} \cdot \frac{U_{L-N}^{NOM}}{Z_{L-N}} \quad I_{SCL-PE\_Min} = C_{MIN} \cdot \frac{U_{L-PE}^{NOM}}{Z_{L-PE}}$$

**Phase – Phase**

**Phase – Neutral**

**Phase – PE**

Measured voltage	$U_{NOM}$	$C_{MIN}$
$230V-10\% < V_{measured} < 230V+ 10\%$	230V	0,95
$230V+10\% < V_{measured} < 400V- 10\%$	$V_{measured}$	1,00
$400V-10\% < V_{measured} < 400V+ 10\%$	400V	0,95

where:

- U L-L = Nominal Phase-Phase voltage
- U L-N = Nominal Phase-Neutral voltage
- U L-PE = Nominal Phase-PE voltage
- Z L-L = Impedance Phase-Phase measured
- Z L-N = Impedance Phase-Neutral measured
- Z L-PE = Impedance Phase-PE measured

## CAUTION



The instrument must be used to measure fault loop impedance values at least 10 times higher than the resolution value of the instrument in order to minimize errors.

Depending on the set values of nominal voltage (see § 5.1.3) and the measured value of fault loop impedance, the instrument calculates the **minimum value** of the assumed short-circuit current to be interrupted by the protection device. For proper coordination, this value **MUST** always be greater than or equal to the **I<sub>a</sub>** value of the tripping current of the type of protection considered.

The **I<sub>a</sub>** reference value depends on:

- Protection type (curve)
- Rated current of the protection device
- Time of fault extinction by the protection

The instrument allows the selection (\*) of the following parameters:

- **MCB curve B** → 3A, 6A, 10A, 13A, 15A, 16A, 20A, 25A, 32A, 40A, 45A, 50A, 63A, 80A, 100A, 125A, 160A, 200A
- **MCB curve C** → 0.5A, 1A, 1.6A, 2A, 3A, 4A, 6A, 10A, 13A, 15A, 16A, 20A, 25A, 32A, 40A, 50A, 63A, 80A, 100A, 125A, 160A, 200A
- **MCB curve D, K** → 0.5A, 1A, 1.6A, 2A, 3A, 4A, 6A, 10A, 13A, 15A, 16A, 20A, 25A, 32A, 40A, 45A, 50A, 63A, 80A, 100A, 125A, 160A, 200A
- **Fuse gG** → 2A, 4A, 6A, 8A, 10A, 12A, 13A, 16A, 20A, 25A, 32A, 35A, 40A, 50A, 63A, 80A, 100A, 125A, 160A, 200A, 250A, 315A, 400A, 500A, 630A, 800A, 1000A, 1250A
- **Fuse aM** → 2A, 4A, 6A, 10A, 12A, 16A, 20A, 25A, 32A, 35A, 40A, 50A, 63A, 80A, 100A, 125A, 160A, 200A, 250A, 315A, 400A, 500A, 630A
- Time of fault extinction by the protection selectable among: **0.1s, 0.2s, 0.4s, 1s, 5s**

(\*) The values could be subject to variations

### 12.11. VERIFICATION OF VOLTAGE DROP ON MAIN LINES

Measurement voltage drop as a result of current flow through a main line or a part of it can be very important if it is necessary:

- Verify the capability of an existing main line to supply a load
- Dimension a new installation
- Search for possible causes of troubles on devices, loads, etc.. connected to a main line

### **Purpose of the test**

Measure the maximum percentage value of voltage drop between two points of a main line

### **Parts of the system to be checked**

The test includes two sequential impedance measurements in the initial point of main power line (typically downstream to a protection device) and in the final point of the same line.

### **Allowable values**

The instrument compares the calculated value of  $\Delta V\%$  maximum voltage drop to the set limit value (according to applicable guidelines) according to the following relationship:

$$\Delta V\%_{MAX} = \frac{(Z_2 - Z_1) * I_{NOM}}{V_{NOM}} * 100$$

where:

- $Z_2$  = End point impedance of the main line being tested
- $Z_1$  = Initial point impedance (Offset) of the main line being tested ( $Z_2 > Z_1$ )
- $I_{NOM}$  = Nominal current of protection device of the main line being tested
- $V_{NOM}$  = Phase-Neutral or Phase-PE nominal voltage of the main line being tested



**HT INSTRUMENTS SA**

C/ Legalitat, 89  
08024 Barcelona - **ESP**  
Tel.: +34 93 408 17 77, Fax: +34 93 408 36 30  
eMail: info@htinstruments.com  
eMail: info@htinstruments.es  
Web: www.htinstruments.es

**HT INSTRUMENTS USA LLC**

3145 Bordentown Avenue W3  
08859 Parlin - NJ - **USA**  
Tel: +1 719 421 9323  
eMail: sales@ht-instruments.us  
Web: www.ht-instruments.com

**HT ITALIA SRL**

Via della Boaria, 40  
48018 Faenza (RA) - **ITA**  
Tel: +39 0546 621002  
Fax: +39 0546 621144  
eMail: ht@htitalia.it  
Web: www.ht-instruments.com

**HT INSTRUMENTS GMBH**

Am Waldfriedhof 1b  
D-41352 Korschenbroich - **GER**  
Tel: +49 (0) 2161 564 581  
Fax: + 49 (0) 2161 564 583  
eMail: info@ht-instruments.de  
Web: www.ht-instruments.de

**HT INSTRUMENTS BRASIL**

Rua Aguaçu, 171, bl. Ipê, sala 108  
13098321 Campinas SP - **BRA**  
Tel: +55 19 3367.8775  
Fax: +55 19 9979.11325  
eMail: vendas@ht-instruments.com.br  
Web: www.ht-instruments.com.br

**HT ITALIA CHINA OFFICE**

**意大利 HT 中国办事处**  
Room 3208, 490# Tianhe road, Guangzhou - **CHN**  
地址 : 广州市天河路 490 号壬丰大厦 3208 室  
Tel.: +86 400-882-1983, Fax: +86 (0) 20-38023992  
eMail: zenglx\_73@hotmail.com  
Web: www.guangzhouht.com